

Rittal – The System.

Faster – better – everywhere.



VX25.
**SYSTEM
PERFECTION.**

- ENCLOSURES
- POWER DISTRIBUTION
- CLIMATE CONTROL
- IT INFRASTRUCTURE
- SOFTWARE & SERVICES



Rittal – The System.

Faster – better – everywhere.



ENCLOSURES

POWER DISTRIBUTION

CLIMATE CONTROL

FRIEDHELM LOH GROUP

VX25. SYSTEM PERFECTION.



CONTENTS

System benefits	from page	20
Frames/punched sections	from page	26
Doors/walls	from page	32
Base/plinths	from page	38
Baying	from page	42
Mounting plate	from page	46
Ordering information		
– Baying enclosure system VX25	from page	52
– System accessories	from page	78
Technical details	from page	200



IT INFRASTRUCTURE

SOFTWARE & SERVICES



VX25.
SYSTEM
PERFECTION.



THE ONE-STOP SUPPLIERS

One partner for everything – Rittal serves the entire value creation chain for enclosure manufacturing. This unrivalled pervasiveness helps to boost efficiency and maintain consistently high standards.

The entire value chain from a single source – The intelligent linking of resources and measures in real time is the defining characteristic of a smooth-running, fully automated process. Rittal facilitates the seamless integration of engineering, systems and automation with a perfect blend of planning aids, system products and machining solutions. Experience the optimum value chain live at the Rittal Innovation Center in Haiger.

IT INFRASTRUCTURE

SOFTWARE & SERVICES





Engineering

With Rittal engineering tools, you can be sure that the data you need is always available at the right time, in the right place, and in the required quality and depth. This enables you to create a virtual prototype.

Benefit: Unrivalled efficiency.

ENCLOSURES

POWER DISTRIBUTION

CLIMATE CONTROL

VX25.
SYSTEM
PERFECTION.



THE WORKFLOW PARTNERS



System

Rittal's comprehensive modular system accommodates every requirement, however individual, and includes enclosure, power distribution, climate control and IT infrastructure systems.

Benefit: Maximum flexibility

Automation

Our extensive portfolio of tools and machining systems is designed to optimise and automate processes, even at workshop level.

Benefit: Exceptional competitiveness.

IT INFRASTRUCTURE

SOFTWARE & SERVICES





ENCLOSURES

POWER DISTRIBUTION

CLIMATE CONTROL

VX25.
SYSTEM
PERFECTION.



THE INVENTORS

Ideas to boost efficiency – It all began with the first standardised enclosure, which led to immediate time and money savings for Rittal's customers. It revolutionised the industry. Even today, improving efficiency for users is still our primary objective. Rittal pursues this goal with passion and inventiveness, as evidenced by our 1,500 patents. The latest example is our VX25 large enclosure system.

Innovations for improved workflows – Rittal develops new solutions to keep its customers at the cutting edge of technology. The VX25 is a new platform which can be integrated seamlessly into fully automated switchgear and controlgear manufacturing. Workflows become more transparent, faster, and more efficient. The digital twin becomes a reality.

IT INFRASTRUCTURE

SOFTWARE & SERVICES



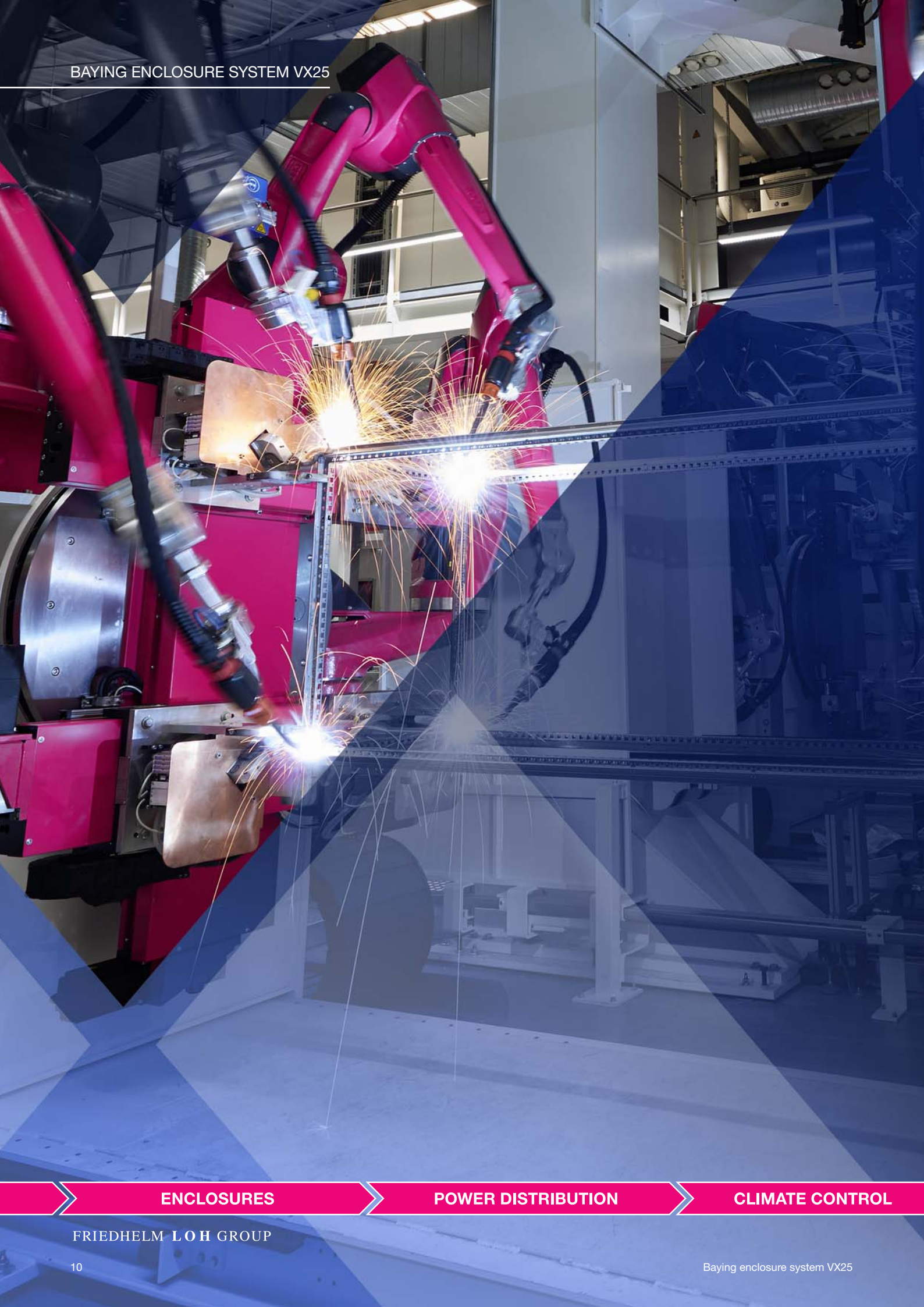

ENCLOSURES

POWER DISTRIBUTION

CLIMATE CONTROL

VX25.
SYSTEM
PERFECTION.



THE MOVERS AND SHAKERS

Manufactured to Industry 4.0 – Made in Germany. The VX25 was developed in Germany, and is also manufactured there to 4.0 standards, using world-class, digitally networked technology. Each day, we produce 15,000 enclosures in 13 production sites on three continents, in a consistently high quality and offering unparalleled flexibility and availability.

World-renowned quality – The VX25, with its internationally recognised approvals and certifications, is ideal for global use and meets the highest quality benchmarks. Compliance with global standards is ensured by stringent testing to international regulations, plus regular production inspections by external test institutes.

IT INFRASTRUCTURE

SOFTWARE & SERVICES





Materialflussgruppe
Partnerschaft gewinnt

Materialflussgruppe
Partnerschaft gewinnt

ENCLOSURES

POWER DISTRIBUTION

CLIMATE CONTROL

VX25.
SYSTEM
PERFECTION.



THE PROBLEM SOLVERS

Fast delivery off the shelf – Rittal's products, including the VX25, are generally available within 24 hours in Europe, and within 48 hours worldwide. To this end, Rittal operates 13 production sites, 58 subsidiaries and around 90 warehouses worldwide. The benefits for Rittal customers include greater flexibility in terms of planning, scheduling and production, less storage space requirements, and reduced capital tie-up.

Fast global service – If you opt for the VX25, you can rely on Rittal's global service operation, dedicated to ensuring plant availability, identifying potential savings, and resolving technical problems in an uncomplicated fashion. The Rittal service network is implemented and maintained by 5 international service hubs, more than 1,000 service engineers working at 150 locations worldwide, and a round-the-clock Rittal service hotline.

IT INFRASTRUCTURE

SOFTWARE & SERVICES





ENCLOSURES

POWER DISTRIBUTION

CLIMATE CONTROL

VX25.
SYSTEM
PERFECTION.



THE GLOBAL MARKET LEADERS

Industry insider – The VX25 is revolutionary when it comes to flexibility and adaptability. And there's a good reason for this: Rittal has an in-depth understanding of the requirements of the various markets, and boasts decades of experience as a partner to all sectors of industry, from automotive, to food, to the aerospace industry.

One-stop supplier – The VX25 is part of the comprehensive Rittal system, available worldwide. It provides everything you need from a modern enclosure manufacturer, from engineering tools, to enclosures, power distribution and climate control, as well as the full range of accessories for assembling and configuring enclosures.

IT INFRASTRUCTURE

SOFTWARE & SERVICES





ENCLOSURES

POWER DISTRIBUTION

CLIMATE CONTROL

VX25.
SYSTEM
PERFECTION.



THE TIME SAVERS

Intuitive configuration translates into time savings of up to 95% – To this end, Rittal has devised an online tool, the Rittal Configuration System. Once you have selected your enclosure, it allows you to precisely position your custom-fit accessories.

Define cut-outs and drilled holes automatically – Even at the configuration stage, the cut-outs required in the panels may be defined with millimetre accuracy and transferred into the plans.

The benefits for you – Finally, the system generates CAD files. Alongside the fully configured design, these files also contain all the data needed to control the Perforex machining centre, making NC-controlled machining of enclosure panels viable even with small batch sizes.

IT INFRASTRUCTURE

SOFTWARE & SERVICES





ENCLOSURES

POWER DISTRIBUTION

CLIMATE CONTROL



THE BENEFIT PROVIDERS

More digitisation

The QR code on all machinable enclosure panels permits fully automated incorporation into the production workflow, for seamless digital monitoring at every stage, from the incoming merchandise through to completion.

More labour-saving

The new hinge is designed for simple, tool-free installation and removal of the doors, eliminating the need to separately unlock and lock the hinge bolts.

More reduction of parts

The frame section, which is identical both horizontally and vertically, allows uniform punched sections and rails to be used throughout, reducing the number of part variants by up to 40%.

More installation security

The stable base frame enables the direct, secure attachment of the enclosure from the inside. The large opening makes it simple to install cables with large bending radii from the mounting plate to the base.

More assembly-friendly

The frame section enables completely unhindered assembly, even from the outside, so that punched sections can be retro-fitted in areas that are no longer accessible from the inside.

IT INFRASTRUCTURE

SOFTWARE & SERVICES





SYSTEM ADVANTAGES – MORE **SYSTEM BENEFITS**

Rittal standards deliver more overarching system advantages that are anything but standard.





Digitisation

The QR code on all the panels that are to be machined simplifies their fully automatic incorporation into the production workflow and enables seamless, digital monitoring from goods receipt through to completion.



Time savings

Precise hole counting offers an easy point of orientation at all levels of the enclosure frame when fixing rails and punched sections in place.

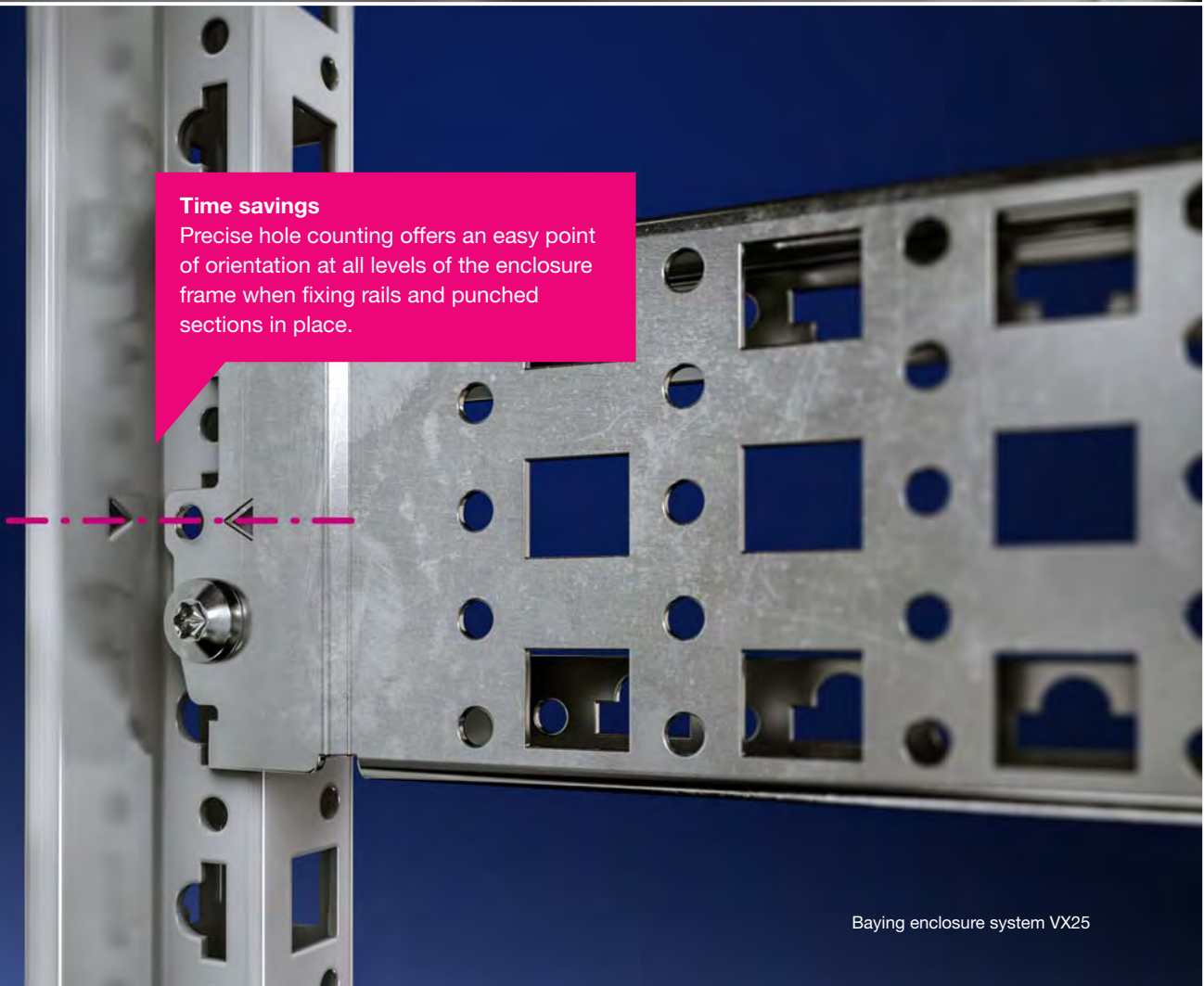

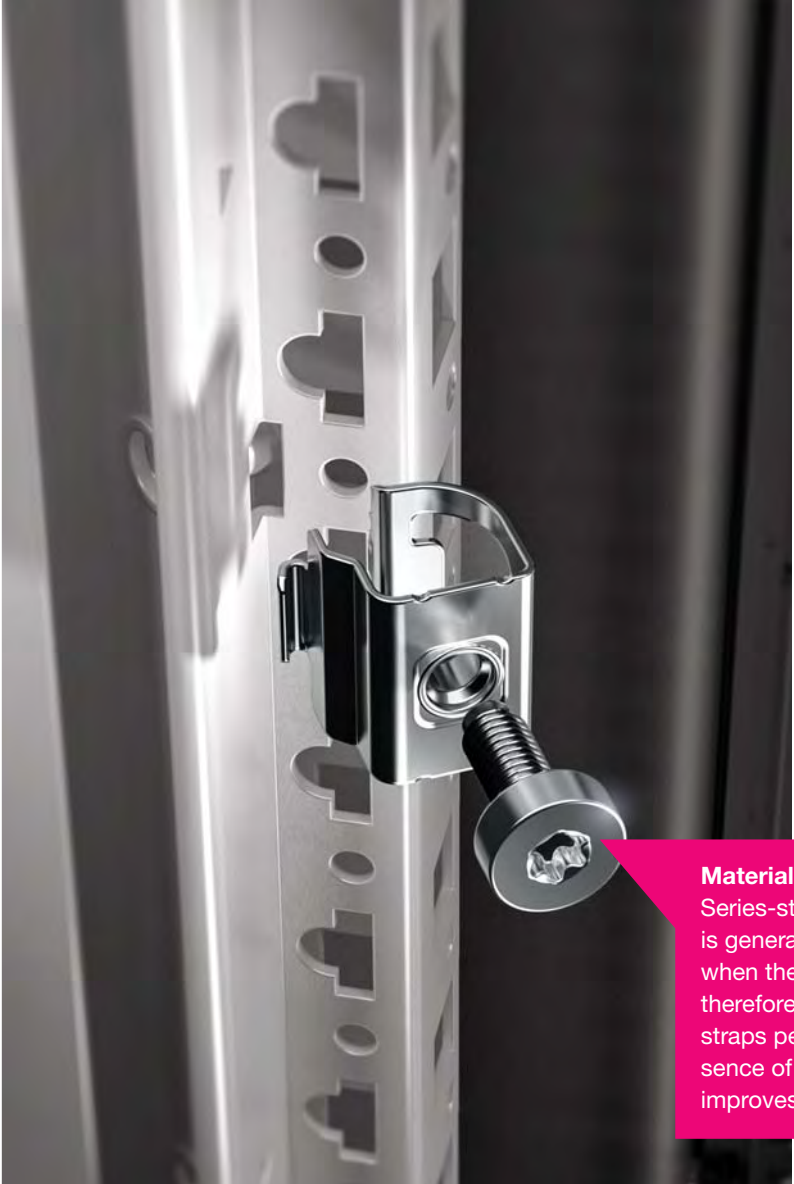

Simplification of work

In the case of one-person assembly, the positioning aid for side and rear panels provides a user-friendly and ideally suited preliminary fixing so that the panels can then be screwed into place using both hands.

Material saving

Series-standard potential equalisation is generated automatically for panels when they are screwed into place, therefore saving up to seven earth straps per enclosure, while the absence of sharp-edged protruding parts improves safety standards at work.



Corrosion protection

The three-stage surface treatment promises optimum corrosion protection and is resistant to mineral oils, lubricants, machining emulsions and several solvents.

- 1 Nanoceramic treatment
- 2 Electrophoretic dipcoat priming
- 3 Powder coating

Safety

The seamless, foamed-in PU seal offers long-term elasticity and can be painted over as required without posing any problems.

System

The automatic potential equalisation in the roof, rear panel and side panels functions as a grounding mechanism when Rittal climate control units and Rittal fan-and-filter units are installed.



Health and safety at work

Rounded edges deliver the highest standards in occupational health and safety when working on the enclosure.

Stability

The seamless, laser-welded, roll-formed enclosure profile ensures optimum force transmission on installed equipment.



Certainty for engineering

Numerous conversion and planning tools help Rittal customers with the automated production process and with work on the virtual prototype.

- Configurators
- Parts list translator
- EPLAN Pro Panel
- 2D/3D CAD data
- ecl@ss Advanced
- Technical documentation
- Data for planners
- Assembly videos



FRAME AND PUNCHED SECTION – MORE **SYSTEM BENEFITS**

More assembly-friendly and efficient engineering thanks to a frame profile with a 25 mm pitch pattern that is symmetrical across all levels and can be accessed from all sides.

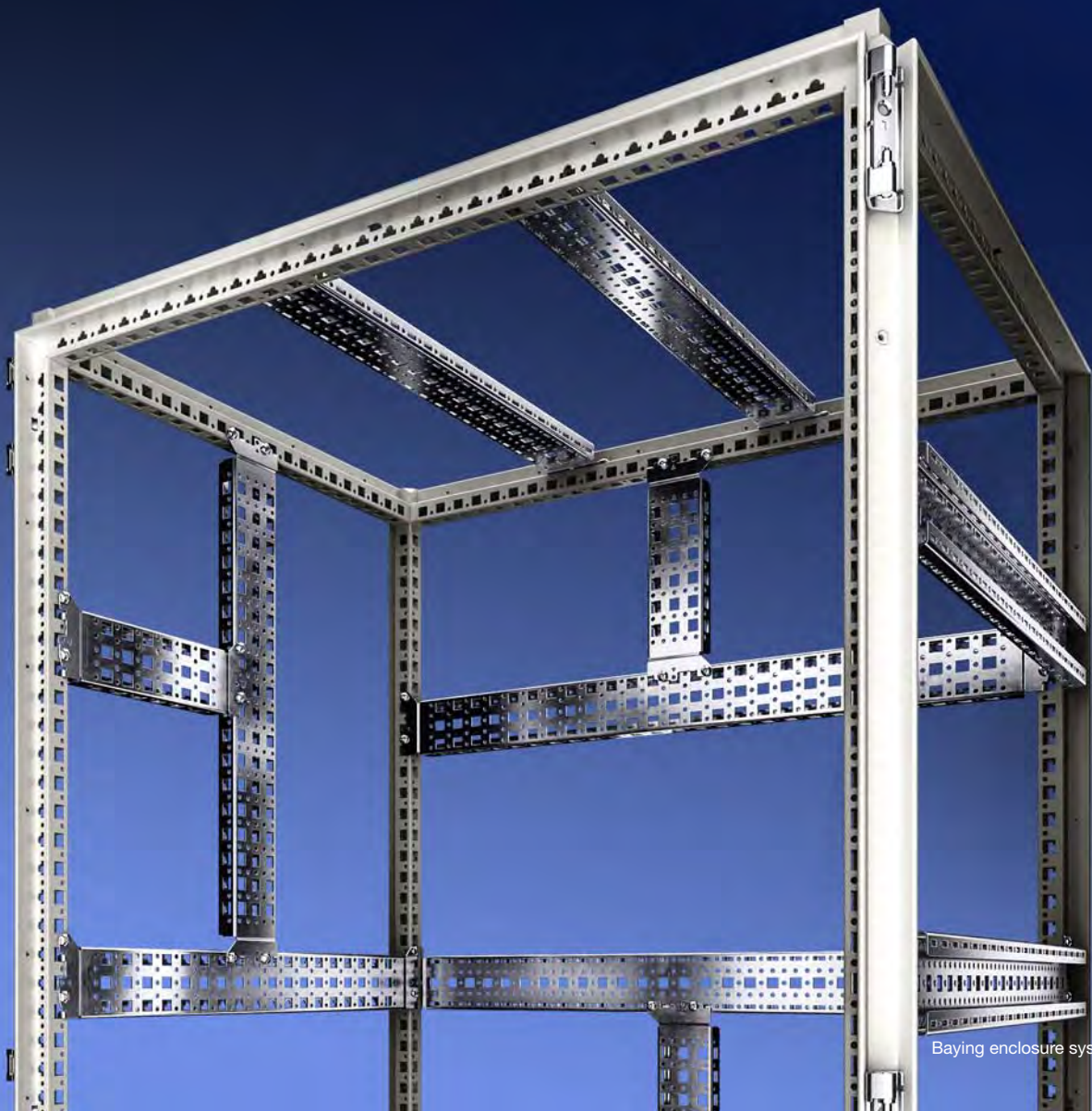

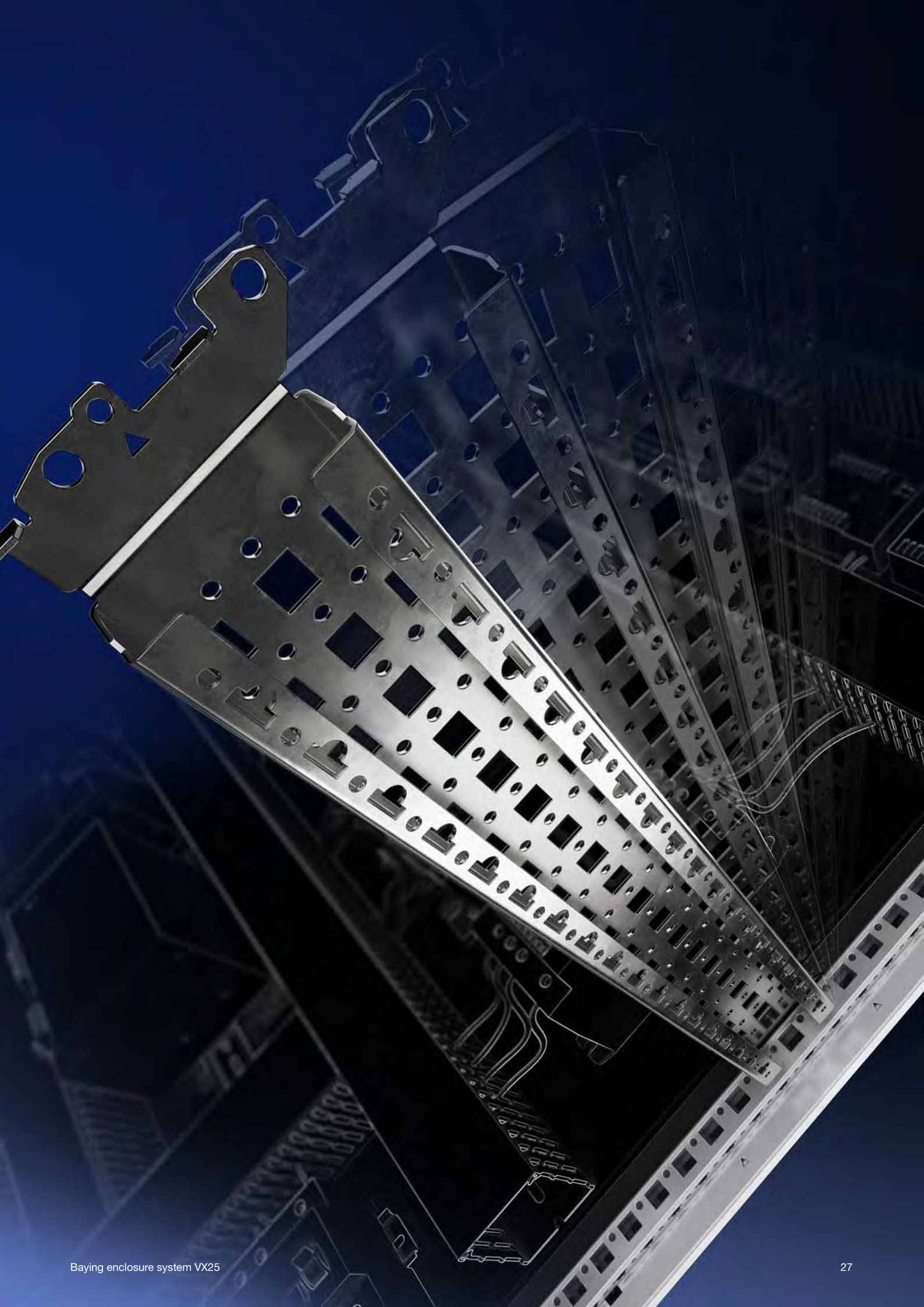



Accessibility

The system offers an outer mounting level in addition to the inner mounting level. That means components can be mounted and the enclosure accessed with ease, even from the outside.

A: Static Structural
Equivalent Stress
Type: Equivalent (von-Mises) Stress
Unit: MPa
Time: 1
07.03.2018 14:25



Stability

Thanks to its ingenious geometry, the patented special profile ensures excellent stability and torsional rigidity.

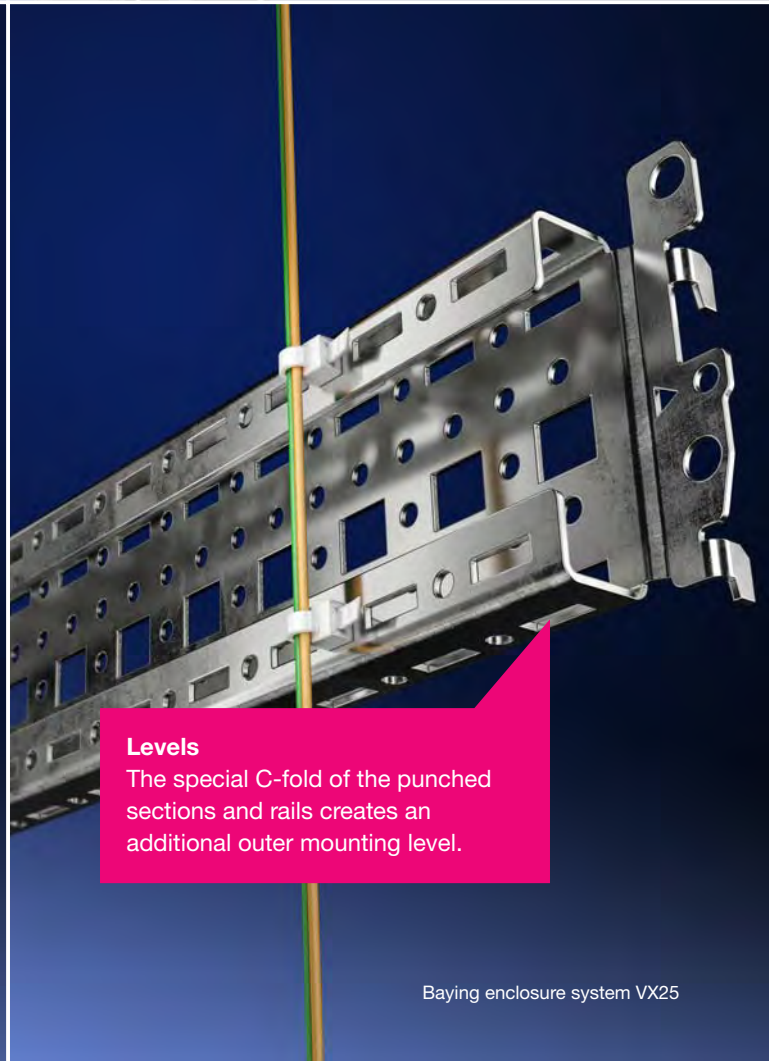

Levels

The special C-fold of the punched sections and rails creates an additional outer mounting level.



Installation options

The continuous pattern of square punching supports the use of M6/M8 cage nuts and thus creates more mounting options at all profile levels.

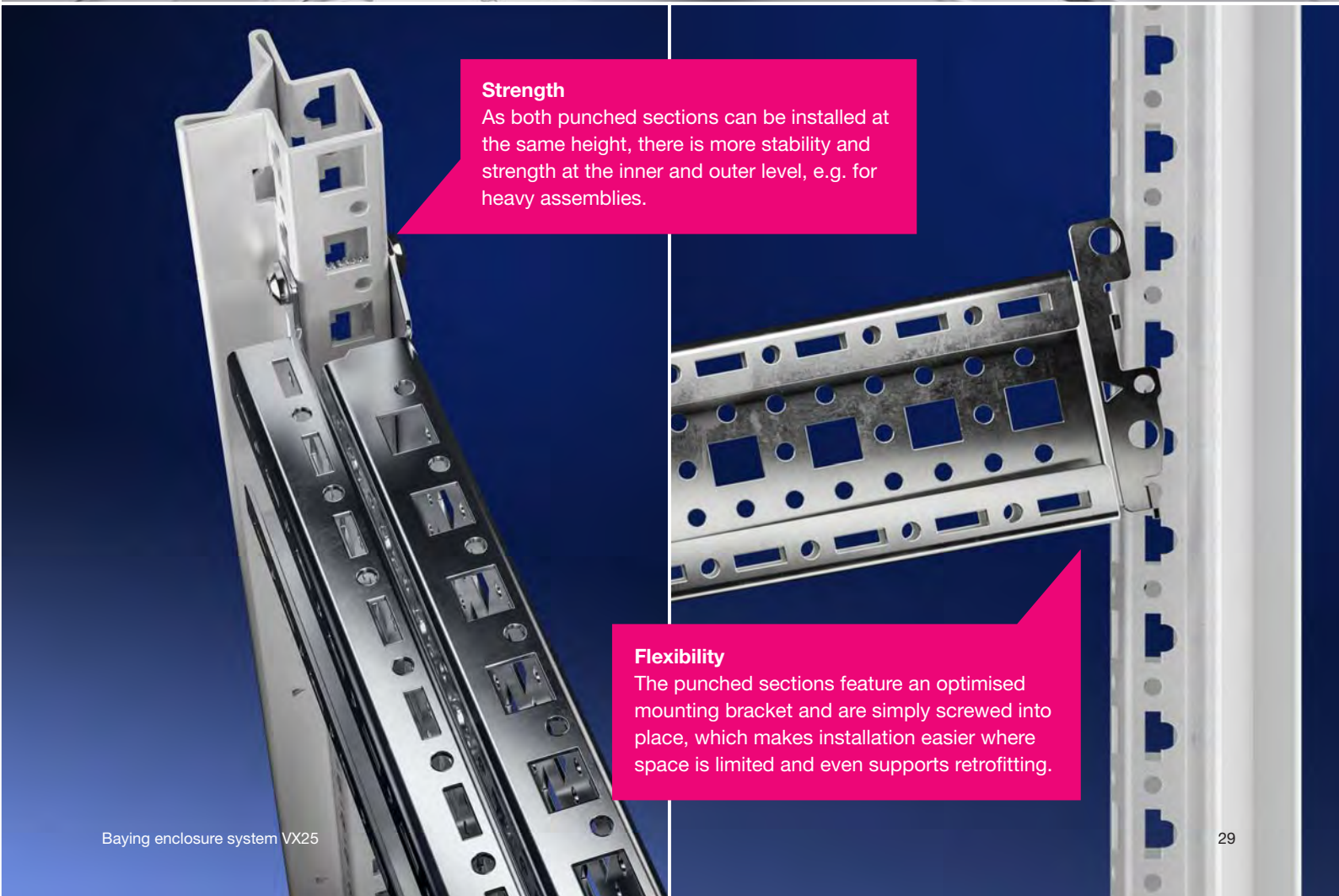

Strength

As both punched sections can be installed at the same height, there is more stability and strength at the inner and outer level, e.g. for heavy assemblies.

Flexibility

The punched sections feature an optimised mounting bracket and are simply screwed into place, which makes installation easier where space is limited and even supports retrofitting.



Ease of assembly

The frame profile allows users to install elements working through the profile from the outside, making it much easier to retrofit punched sections in places that can no longer be reached from the inside.

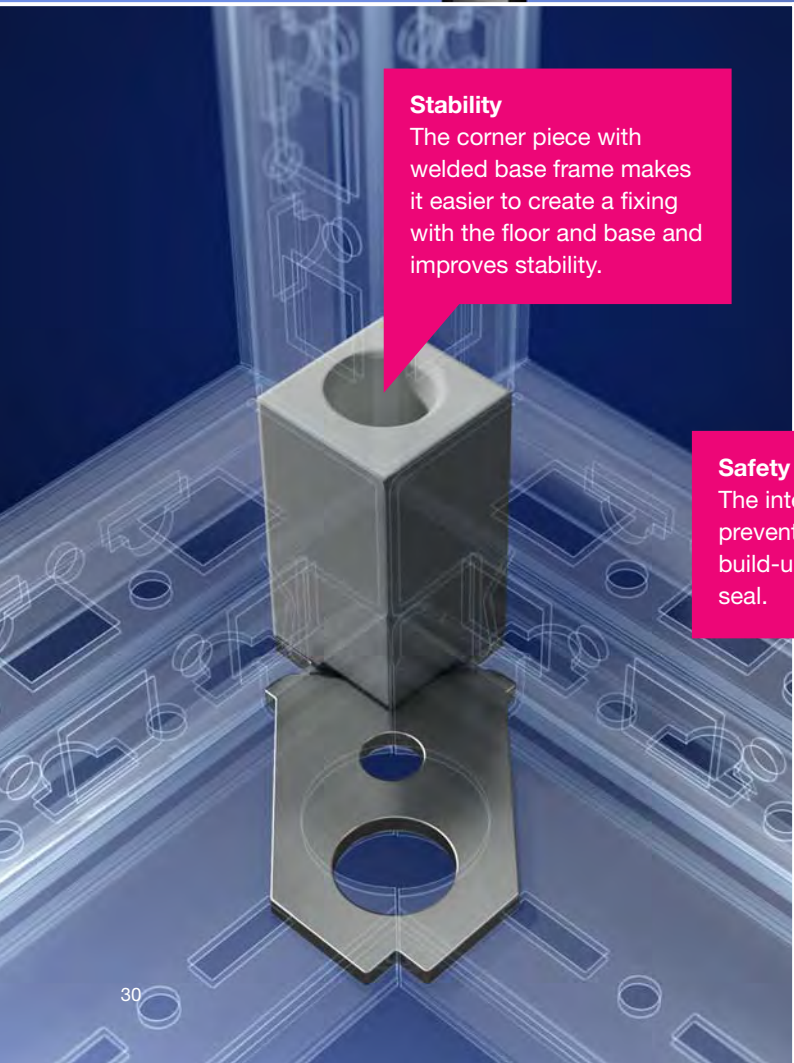

Stability

The corner piece with welded base frame makes it easier to create a fixing with the floor and base and improves stability.

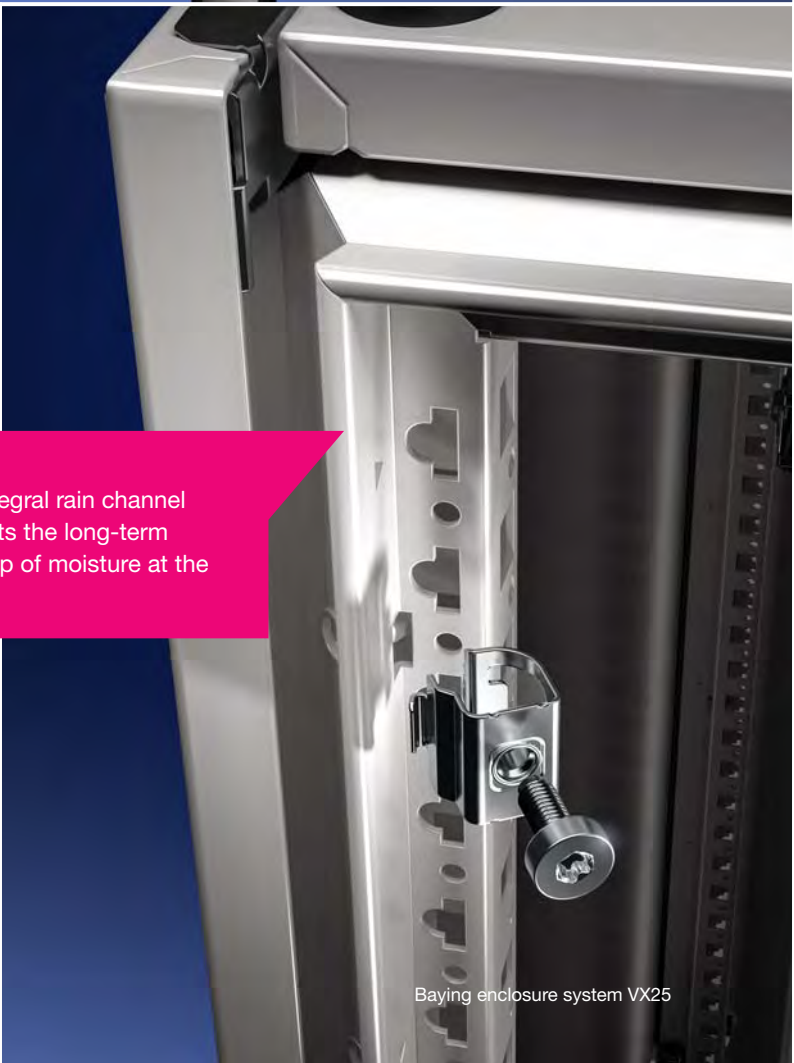

Safety

The integral rain channel prevents the long-term build-up of moisture at the seal.



Mounting options

Using the standard punched section, including to support the roof and side panels, simplifies engineering and assembly, and relieves pressure on the parts warehouse.

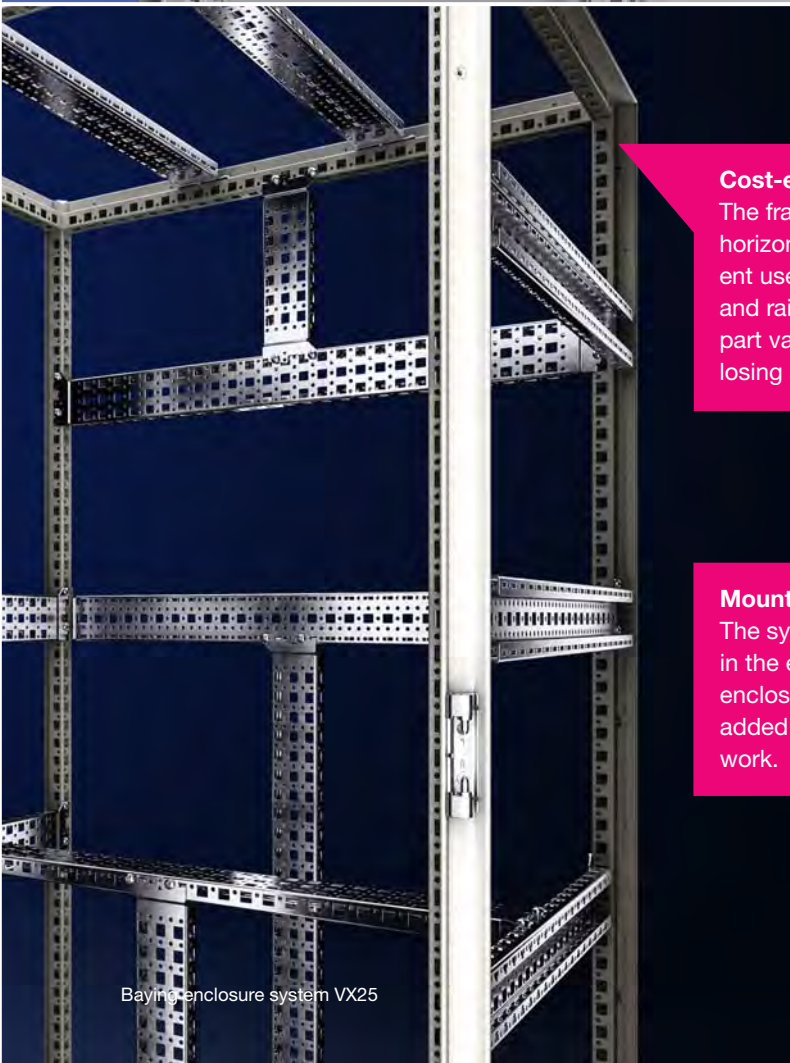

Cost-efficiency

The frame profile, which is identical horizontally and vertically, enables consistent use of standardised punched sections and rails, which reduces the number of part variants by up to 40 per cent without losing any functionality.

Mounting plates

The system divider intended for installation in the enclosure depth divides wide enclosures into two halves and thus offers added flexibility for internal installation work.





DOORS AND WALLS – MORE **TIME**

More flexibility, easier installation and better cost-efficiency thanks to ingenious hinge technology, fast-action interchangeable and installable closure technology and saving on machining processes.





Simplification of work

Thanks to the new hinge, doors can be installed and removed incredibly easily and without needing any tools, thus eliminating the need to separately lock and unlock hinge bolts.

Time savings

There is no need to machine the door when installing the 180° hinge, which reduces the installation time during retrofitting by up to 30 minutes per door.



Time savings

The simple, tool-free exchangeability of lock systems such as the comfort handle reduces the necessary installation time by up to 50 per cent.



Simplification of work

In the case of one-person assembly, the positioning aid for side and rear panels provides a user-friendly and ideally suited preliminary fixing so that the panels can then be screwed into place using both hands.



Safety

The adjacent door latch mechanism is operated from outside for extra convenience and safety because users don't have to reach inside the enclosure.

Ease of assembly

The innovative clip mechanism of the panel holders speeds up the installation of side panels.

Access

The panel holders can also be easily retrofitted and are clipped into place from the outside without having to first remove previously installed rear panels.

Expansion options

Thanks to its ingenious geometry, the special profile ensures excellent stability, torsional rigidity and flexibility for door installations.

Processability

The QR code on all the panels that are to be machined simplifies their fully automatic incorporation into the production workflow and enables seamless, digital monitoring from goods receipt through to completion.





Flexibility

The opportunity to change the opening direction of main and adjacent doors on double-door enclosures according to needs, creates added flexibility when installing cooling units in enclosure doors and prevents collisions between equipment and doors.



Accelerator

The series-standard T-head punching in the tubular door frame speeds up the process of laying cables in the door. Cables can be fixed to the door extremely quickly, even when using conventional commercial cable ties.

Usable height

The flat centre seal does not obstruct the movement of the swing frame or other components.



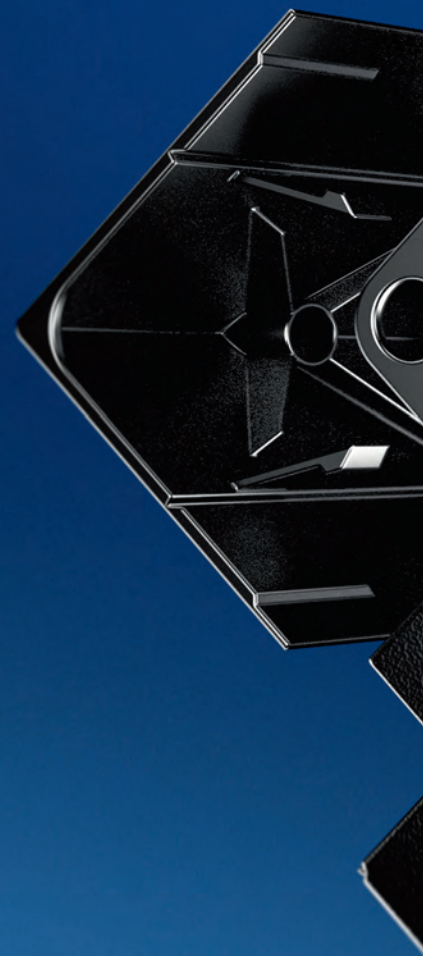

BASE AND FLOOR – MORE **SPACE**

Make better use of space, simplify work and save time thanks to the outstanding compatibility of the enclosure and base – even when buying enclosures and fitting accessories.



Variability

Enclosures can be fastened to the base/plinth or subsurface via either an M12 thread in the corner piece or the stable floor design.



Ease of use

A direct screw connection between the base/plinth components and the enclosure automatically creates potential equalisation without having to incorporate any earth straps.

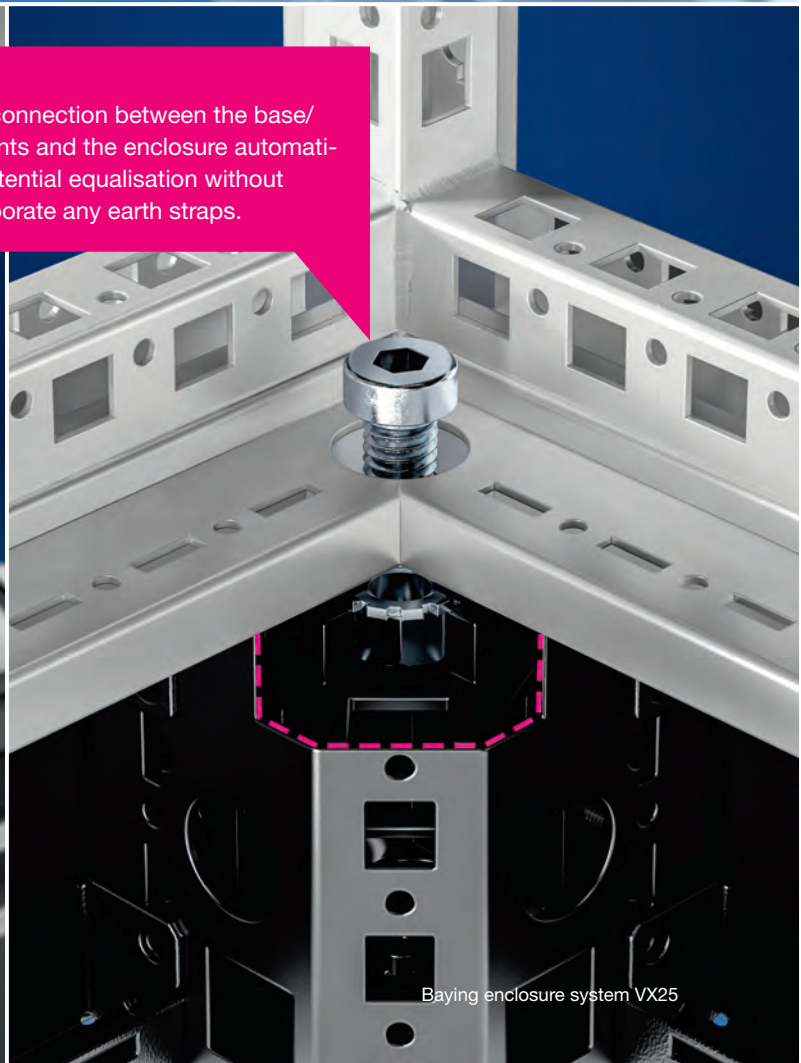

Precision

The centring aid for base/plinth mounting on the enclosure frame ensures the enclosure is positioned precisely on the base/plinth and also safeguards the IP protection category and frame protection when used without a base/plinth.



Time savings

The simple screw fixing of the gland plates is quick to implement and also automatically creates potential equalisation in one single step.

Transparency

The identifying dimensions stamped on the gland plates make it easier to match the gland plates to the right enclosure.

Space for cables

The large opening in the stable base frame makes it much easier to lay cables.



Simplification of work

Thanks to their series-standard marking, the earthing points help users easily find their bearings and speed up work.

Cable care

Thanks to rounded edges, cables routed under the enclosure are not at risk of being damaged.

Rigidity

The double edge fold on the gland plates prevents deformation even under heavy loads and thus ensures compliance with the high protection category.



BAYING – MORE **SIMPLIFICATION**

Drive down complexity with simplified, more consistent baying technology for all applications.



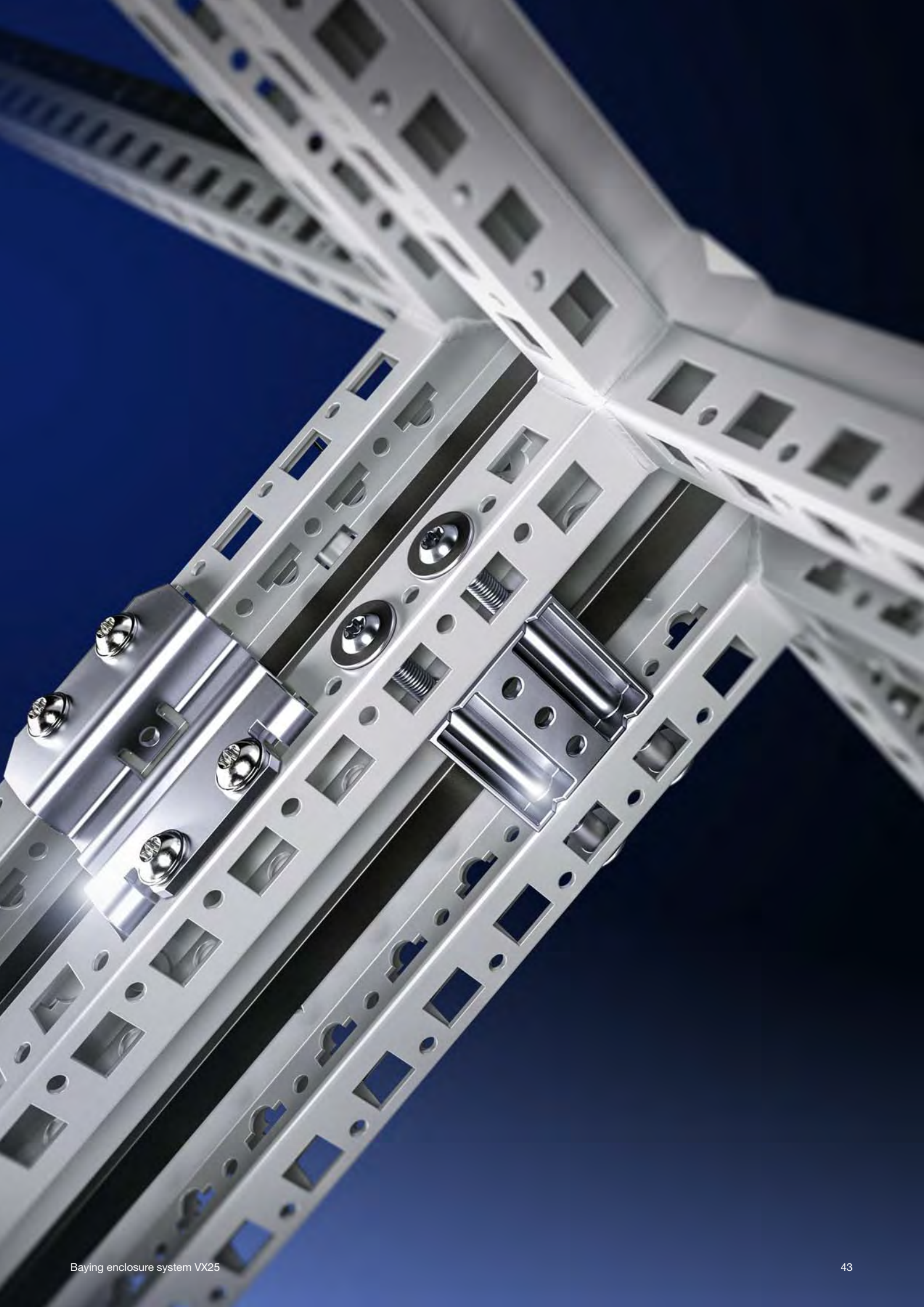

Overview

The baying connectors are designed so that all the baying scenarios that crop up in enclosure engineering can be covered with a maximum of just three different baying solutions. That means it is easier to make decisions and takes some of the hard work out of engineering.

Location flexibility

The option to bay enclosures on all four sides means users can adopt their own approach to tackling any imaginable space.



Sealing efficiency

Fitted in a blink of an eye, the seal can be positioned precisely where needed and can be removed again at any time.

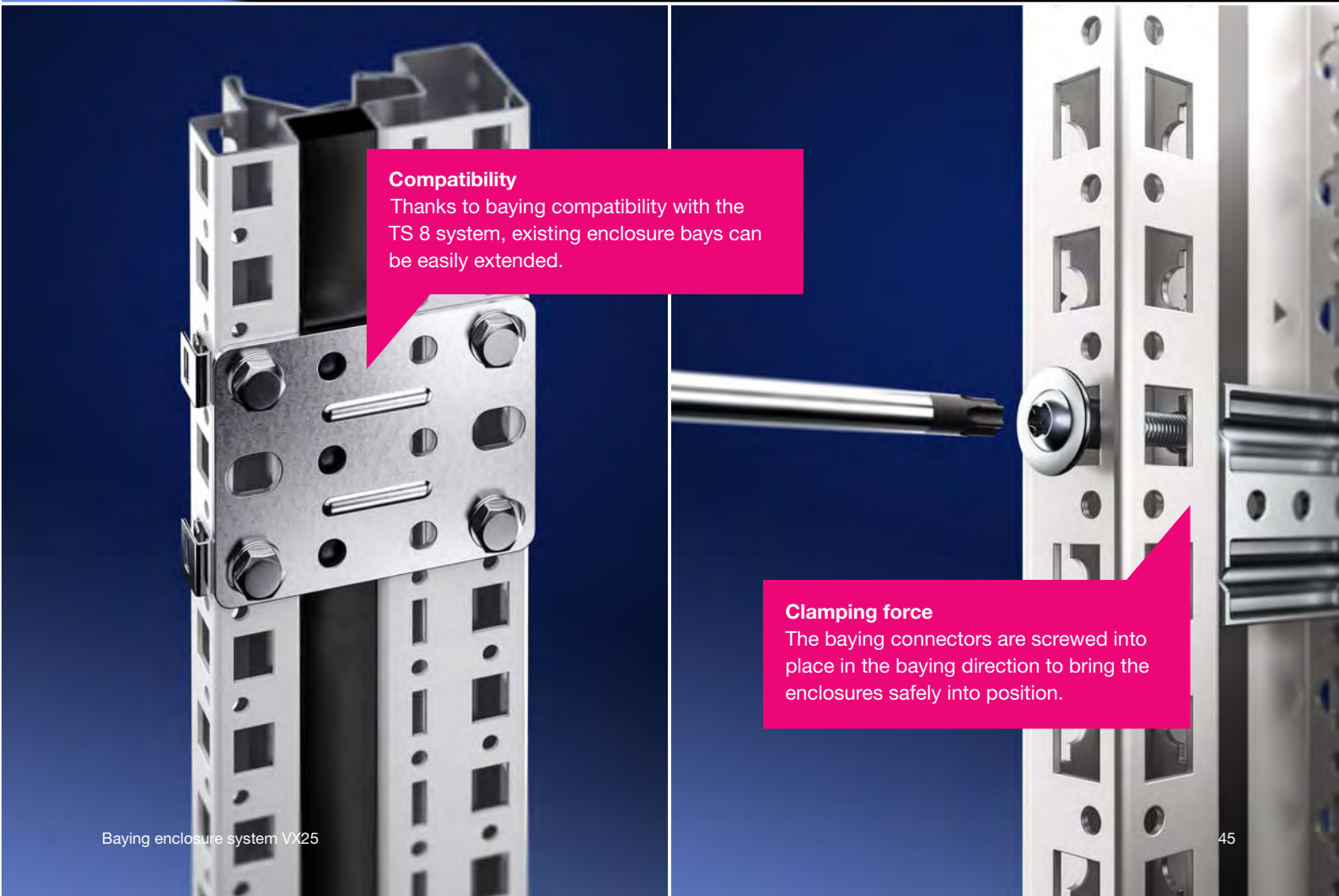

Compatibility

Thanks to baying compatibility with the TS 8 system, existing enclosure bays can be easily extended.

Clamping force

The baying connectors are screwed into place in the baying direction to bring the enclosures safely into position.



MOUNTING PLATE – MORE **EASE OF ASSEMBLY**

More time savings, installation options and ease of assembly thanks to improved installation kits, including for dynamic loads.



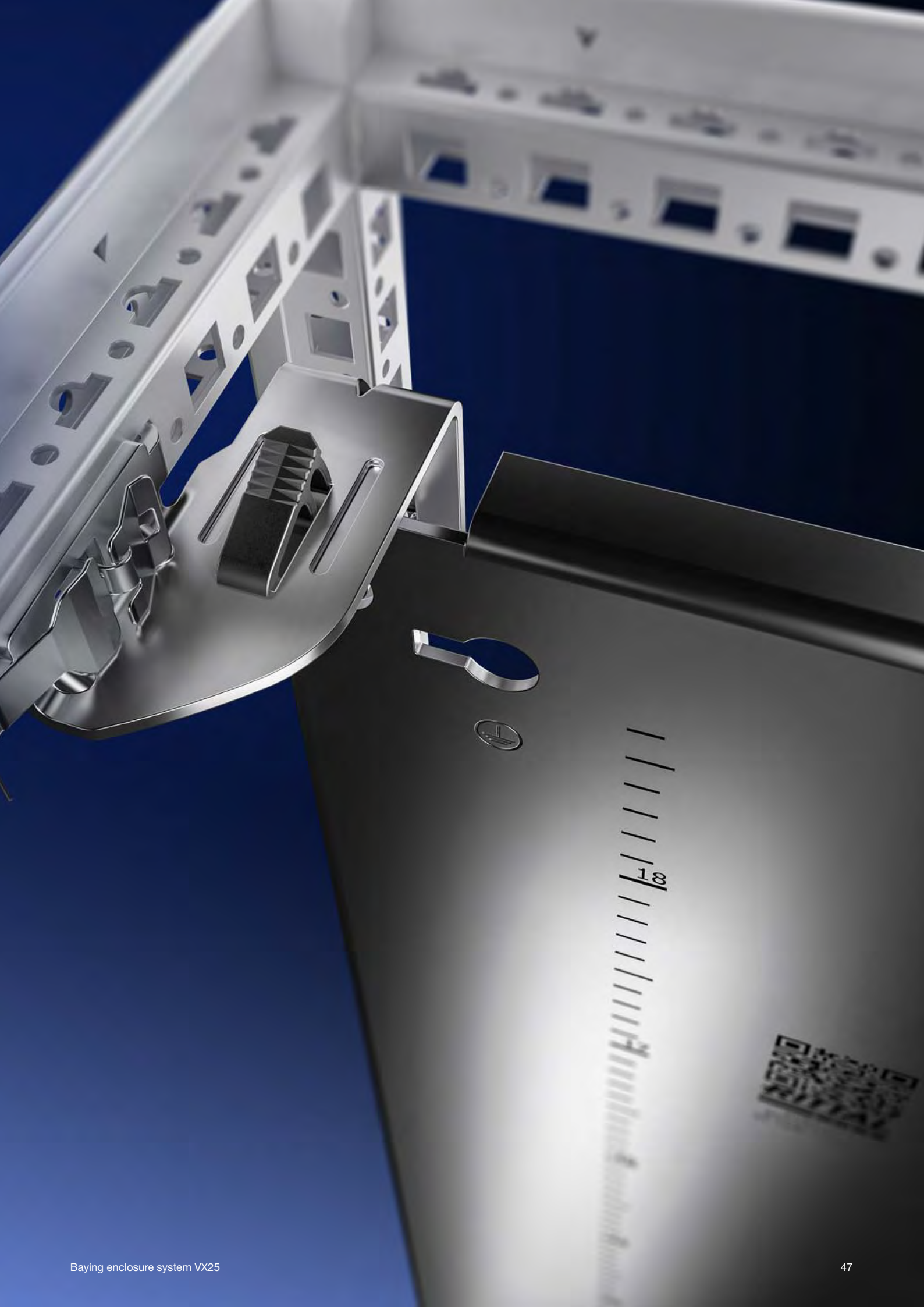

Additional benefits

The practical mounting plate slide rail can be removed once the mounting plate has been inserted and reused at another position in the enclosure as a fully-fledged punched section.

Digitisation

The QR code on all the panels that are to be machined simplifies their fully automatic incorporation into the production workflow and enables seamless, digital monitoring from goods receipt through to completion.

Process efficiency

Thanks to its integrated clip, the mounting plate slide block can be easily removed and reinstalled without the need for tools, thus making work around the fully automatic machining process easier.





More space

The option of using a special installation kit to install the mounting plate 20 mm deeper into the enclosure creates additional space in the depth of the enclosure.

Ease of placement

The printed scale ensures components can be easily and quickly positioned on the mounting plate – without having to carry out separate measurements.



Flexibility

Thanks to the potential for depth adjustment in the 25 mm pitch pattern, the mounting plate can be installed at the optimum position for the application.



Convenient fixing

The clip at the top end of the mounting plate holds it in place during one-person assembly until the plate can be screwed into position.

FIND WHAT YOU NEED EASILY – WITH BONUS INFORMATION

Product overview

Here you will find all the dimensions and designs at a glance.

Page 52/53



			Basic enclosure		Electronic enclosure ¹⁾
Height x depth mm	Width mm	Doors	Model No.	Model No.	Model No.
			Sheet steel	Stainless steel	Sheet steel
1200 x 500	600	1	8615.000	-	-
	800	1	8815.000	-	-
	1200	2	8215.000	-	-
1400 x 500	600	1	8645.000	-	-
	800	1	8845.000	-	-
	1200	2	8245.000	-	-
1600 x 500	600	1	8665.000	-	-
	800	1	8865.000	-	-
	1200	2	8265.000	-	-
1600 x 600	600	1	-	-	8410.000
1600 x 800	600	1	-	-	8418.000

Benefits

The VX25 is packed full of interesting innovations. Read here if you would like to understand how they benefit you.

Page 19 – 49



Ordering information for the buying enclosure system VX25

Once you have chosen a suitable enclosure, in the column below you will find the Model Numbers for those all-important matching accessories. Details of these accessory components are easily referenced using the page numbers in the right-hand column.

Page 54 – 75



Material and surface finish:

- Enclosure frame: Sheet steel, 1.5 mm, dipcoat-primed
- Roof: Sheet steel, 1.5 mm, dipcoat-primed, powder-coated on the outside, textured paint
- Front frame: Extruded aluminium section, powder-coated
- Rear door: Sheet steel, 2 mm, dipcoat-primed, powder-coated on the outside, textured paint

Colour:

- RAL 7035

Supply includes:

- Enclosure frame
- Front frame (r/h hinge, held on the left via mechanical snap fasteners)
- Rear door (l/h hinge, may be swapped to opposite side)
- Roof plate
- Gland plates
- Adaptor sections, 482.6 mm (19"), front

Approvals:

- UL
- eUL

Electronic enclosure

Height units U	P. of	33	33	42	42	Page
Width mm		800	800	800	800	85
Height mm		1600	1600	2000	2000	
Depth mm		600	800	600	600	
Model No.	1 pcs.	8410.000	8418.000	8430.000	8438.000	
Weight, approx. kg		81.5	67.5	89.4	75.4	

Accessories

	2 pcs.	8920.002	8920.002	8920.002	8950.002	85
Base/plinth corner pieces with base/plinth trim panel, front and rear, 100 mm	2 pcs.	8920.033	8920.034	8920.033	8920.034	86
Base/plinth trim panels, sides, 100 mm	2 pcs.	8920.022	8920.022	8920.043	8920.044	86
Base/plinth corner pieces with base/plinth trim panel, front and rear, 200 mm	2 pcs.	8912.000	8912.000	8912.000	8912.000	91
Base/plinth trim panels, sides, 200 mm	4 pcs.	8166.245	8168.245	8168.245	8168.245	96
Levelling feet	2 pcs.	8618.200	8618.200	8618.200	8618.200	120
Side panels, screw-fastened, sheet steel	1 pcs.	8618.230	8618.230	8618.230	8618.230	120
Comfort handle VX for lock inserts	1 pcs.	8618.250	8618.250	8618.250	8618.250	120
Comfort handle VX for lock inserts and padlock	1 pcs.	8618.250	8618.250	8618.250	8618.250	120
Comfort handle VX for semi-cylinder	1 pcs.	8618.250	8618.250	8618.250	8618.250	120

Knowledge is about knowing where to find the right information. It may sound banal, but there is a serious message here. This brochure contains a wealth of information for all relevant target groups within your company, and it is well worth looking at this page. You will find valuable information to help you find the right solution quickly and easily.



Important information on the use of accessories

To enable you to fully appreciate the benefits of our accessory range, each chapter highlights the principal applications. Allow us to inspire you, and explore the vast range of opportunities.

From page 78

Enclosure frame
The patented profile is completely symmetrical across all levels and equipped with 25 mm system punchings that are consistently retained even across multiple enclosures.

Two mounting levels
The two mounting levels, spaced 25 mm apart, allow optimum flexibility and maximise the space available for interior installation.

1 Outer mounting level
2 Inner mounting level

Punched section with mounting flange for the inner mounting level
The punched section with mounting flange supports system configuration on a 25 mm pitch pattern across all levels of the VX25, even beyond enclosure boundaries. Cage nuts up to M8 may be used in the system punchings on three levels. In this way, your own components can be securely fastened with metric screws. Direct mounting on the horizontal enclosure section is also supported.

Punched section with mounting flange for the outer mounting level
The punched section is easily retro-fitted, even with the side panel already installed, because the rounded edges allow it to be screwed in. The additional C-fold may be used to support heavy installed equipment on the side panel or roof, or for attaching cable connectors.

Ordering information for accessories

All accessory components are described and presented in depth. The detailed information on each product ensures that nothing is forgotten, and any special features can be incorporated into your planning.

From page 78

Interior installation

Rail systems

Punched section with mounting flange, 23 x 89 mm

For variable, individual interior installation of the enclosure frame on the inner mounting level. Simply locate into punchings and screw-fasten. System punchings on all four sides. With slots at the top and bottom for cage nuts, for attaching your own components via metric screws. Especially for cable routing in the base/plinth system VX, stainless steel and for the installation of busbar supports (non-magnetic stainless steel).

Installation options:

- On the inner mounting level, on the enclosure section
- On identical punched sections with mounting flanges
- Base/plinth system VX, stainless steel, in the width and depth, combined with a base/plinth installation bracket

Material:
- Stainless steel

Supply includes:
- Assembly parts

For enclosure width/depth mm	P. of	Model No.
400	2 (pairs)	8100.730
500	2 (pairs)	8100.731
600	2 (pairs)	8100.732
800	2 (pairs)	8100.733

Accessories:

- Screws, see page 158
- Cable ties 2597.000, see page 186
- Cage nuts, see page 157
- Base/plinth installation bracket, see page 89

Technical details

All the main dimensions of the VX25 are shown here in a compact, clear format, without electronic aids. Should you require more detailed information, this can be found at www.rittal.com

Page 200 – 212

Note:

- With fitted side panels, the overall width (B1) is increased by 13 mm.
- Between bayed enclosures, allow 1 mm for the seal.

Baying enclosure system VX25



			Basic enclosure from page 54/71		Electronic enclosure ¹⁾ from page 66	
Height x depth mm	Width mm	Doors	Model No.	Model No.	Model No.	
Material			Sheet steel	Stainless steel	Sheet steel	
1200 x 500	600	1	8615.000	-	-	
	800	1	8815.000	-	-	
	1200	2	8215.000	-	-	
1400 x 500	600	1	8645.000	-	-	
	800	1	8845.000	-	-	
	1200	2	8245.000	-	-	
1600 x 500	600	1	8665.000	-	-	
	800	1	8865.000	-	-	
	1200	2	8265.000	-	-	
1600 x 600	600	1	-	-	8410.000	
1600 x 800	600	1	-	-	8418.000	
1800 x 400	600	1	8684.000	-	-	
	800	1	8884.000	8454.000	-	
	1000	1	8084.000	-	-	
	1000	2	8080.000	-	-	
	1200	2	8284.000	8456.000	-	
1800 x 500	400	1	8485.000	-	-	
	600	1	8685.000	8457.000	-	
	800	1	8885.000	8455.000	-	
	800	2	8880.000	-	-	
	1200	2	8285.000	8453.000	-	
1800 x 600	400	1	8486.000	-	-	
	600	1	8686.000	-	-	
	800	1	8886.000	-	-	
	800	2	8881.000	-	-	
	1200	2	8286.000	-	-	
2000 x 400	400	1	-	-	-	
	600	1	8604.000	-	-	
	800	1	8804.000	-	-	
	850	1	-	-	-	
	1000	2	8004.000	-	-	
	1100	2	-	-	-	
	1200	2	8204.000	-	-	
2000 x 500	400	1	8405.000	-	-	
	600	1	8605.000	-	-	
	800	1	8805.000	-	-	
	1000	2	8005.000	-	-	
	1200	2	8205.000	-	-	
2000 x 600	400	1	8406.000	-	-	
	600	1	8606.000	8452.000	8430.000	
	800	1	8806.000	8450.000	-	
	850	1	-	-	-	
	1000	2	8006.000	-	-	
	1100	2	-	-	-	
	1200	2	8206.000	8451.000	-	
2000 x 800	400	1	-	-	-	
	600	1	8608.000	-	8438.000	
	800	1	8808.000	-	-	
	1200	2	8208.000	-	-	
2200 x 600	400	1	-	-	-	
	600	1	8626.000	-	-	
	800	1	8826.000	-	-	
	1200	2	8226.000	-	-	
2200 x 800	400	1	-	-	-	
	600	1	-	-	-	
	800	1	-	-	-	

¹⁾ Rear door

Baying enclosure system VX25



			IP 66/NEMA 4 from page 67	IP 66/NEMA 4X from page 75	Distribution enclosures from page 68	Modular enclosure ²⁾ from page 69
	Width mm	Doors	Model No.	Model No.	Model No.	Model No.
			Sheet steel	Stainless steel	Sheet steel	Sheet steel
	600	1	-	-	-	-
	800	1	-	-	-	-
	1200	2	-	-	-	-
	600	1	-	-	-	-
	800	1	-	-	-	-
	1200	2	-	-	-	-
	600	1	-	-	-	-
	800	1	-	-	-	-
	1200	2	-	-	-	-
	600	1	-	-	-	-
	600	1	-	-	-	-
	800	1	-	-	-	-
	1000	1	-	-	-	-
	1000	2	-	-	-	-
	1200	2	-	-	-	-
	400	1	-	-	-	-
	600	1	-	-	-	-
	800	1	-	-	-	-
	800	2	-	-	-	-
	1200	2	-	-	-	-
	400	1	-	-	-	-
	600	1	-	-	-	-
	800	1	-	-	-	-
	800	2	-	-	-	-
	1200	2	-	-	-	-
	400	1	-	-	-	-
	600	1	-	-	-	-
	800	1	-	-	-	-
	850	1	-	-	9666.956	-
	1000	2	-	-	-	-
	1100	2	-	-	9666.966	-
	1200	2	-	-	-	-
	400	1	-	-	-	-
	600	1	-	-	-	-
	800	1	-	-	-	-
	1000	2	-	-	-	-
	1200	2	-	-	-	-
	400	1	-	-	-	9680.406
	600	1	-	-	-	9680.606
	800	1	8807.000	8458.000	-	9680.806
	850	1	-	-	9666.916	-
	1000	2	-	-	-	-
	1100	2	-	-	9666.926	-
	1200	2	-	-	-	-
	400	1	-	-	-	9680.408
	600	1	-	-	-	9680.608
	800	1	-	-	-	9680.808
	1200	2	-	-	-	-
	400	1	-	-	-	9680.426
	600	1	-	-	-	9680.626
	800	1	-	-	-	9680.826
	1200	2	-	-	-	-
	400	1	-	-	-	9680.428
	600	1	-	-	-	9680.628
	800	1	-	-	-	9680.828

²⁾ Without door

Baying enclosure system VX25



System accessories Page 78 VX25, stainless steel Page 71

Material and surface finish:

- Enclosure frame: Sheet steel, 1.5 mm, dipcoat-primed
- Roof: Sheet steel, 1.5 mm, dipcoat-primed, powder-coated on the outside, textured paint
- Door: Sheet steel, 2 mm, dipcoat-primed, powder-coated on the outside, textured paint
- Rear panel: Sheet steel, 1.5 mm, dipcoat-primed, powder-coated on the outside, textured paint
- Gland plates: Sheet steel, 1.5 mm, zinc-plated
- Mounting plate: Sheet steel, 3 mm, zinc-plated

Colour:

- RAL 7035

Protection category IP to IEC 60 529:

- IP 55

NEMA protection category:

- NEMA 12

Supply includes:

- Enclosure frame
- Door(s) (r/h hinge, may be swapped to opposite side)
- Roof plate
- Rear panel
- Gland plates
- Mounting plate
- 2 punched rails 18 x 39 mm
- Lock: 3 mm double-bit

Approvals:

- UL
- cUL
- Further approvals can be found on the Internet

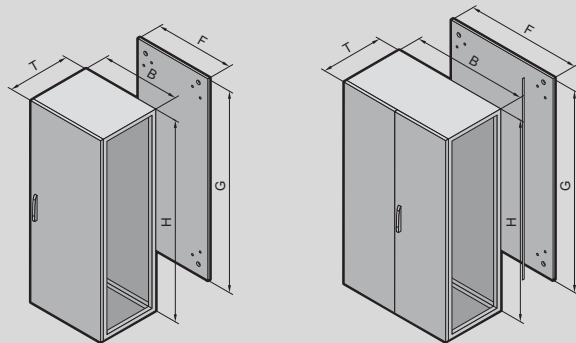

Baying enclosure system VX25

Basic enclosure, height 1200 mm, depth 500 mm

Width (B) mm	P. of	600	800	1200	Page
Height (H) mm		1200	1200	1200	
Depth (T) mm		500	500	500	
Mounting plate width (F) mm		499	699	1099	
Mounting plate height (G) mm		1096	1096	1096	
Model No.	1 pc(s).	8615.000	8815.000	8215.000	
Weight, approx. kg		74.5	92.1	140.0	
Product-specific scope of supply					
Door(s)		1	1	2	
Accessories					
Base/plinth corner pieces with base/plinth trim panel, front and rear, 100 mm	2 pc(s).	8620.002	8620.003	8620.007	85
Base/plinth trim panels, sides, 100 mm	2 pc(s).	8620.032	8620.032	8620.032	86
Base/plinth corner pieces with base/plinth trim panel, front and rear, 200 mm	2 pc(s).	8620.022	8620.023	8620.025	85
Base/plinth trim panels, sides, 200 mm	2 pc(s).	8620.042	8620.042	8620.042	86
Levelling feet	4 pc(s).	4612.000	4612.000	4612.000	91
Side panels, screw-fastened, sheet steel	2 pc(s).	8115.245	8115.245	8115.245	96
Divider panel	1 pc(s).	–	–	–	
Divider panel for module plates	1 pc(s).	–	–	–	
Baying bracket, internal	6 pc(s).	8617.500	8617.500	8617.500	106
Baying block, internal	6 pc(s).	8617.501	8617.501	8617.501	106
Baying connector, external	6 pc(s).	8617.502	8617.502	8617.502	106
Glazed door	1 pc(s).	–	–	–	
Comfort handle VX for lock inserts	1 pc(s).	8618.200	8618.200	8618.200	120
Comfort handle VX for lock inserts and padlock	1 pc(s).	8618.230	8618.230	8618.230	120
Comfort handle VX for semi-cylinder	1 pc(s).	8618.250	8618.250	8618.250	120
Comfort handle with security lock insert, lock E1	1 pc(s).	8618.240	8618.240	8618.240	120
Comfort handle VX for ASSA lock system	1 pc(s).	8618.270	8618.270	8618.270	120
Lock inserts		see page	see page	see page	121
180° hinges	4 pc(s).	8618.330	8618.330	8618.330	111
Punched section with mounting flange, 14 x 39 mm, for tubular door frame	4 pc(s).	8619.720	8619.730	8619.720	126
Wiring plan pocket, sheet steel, depth 35 mm	1 pc(s).	4116.500	4118.500	4116.500	127
Wiring plan pocket, sheet steel, depth 90 mm	1 pc(s).	4116.000	4118.000	4116.000	127
Door stay for escape routes	1 pc(s).	8618.400	8618.400	8618.400	128
Ride-up roller	10 pc(s).	8618.420	8618.420	8618.420	128
Mounting plate infill	1 pc(s).	–	–	–	
Punched section with mounting flange 18 x 64 mm for the outer level, in the width	4 pc(s).	8617.030	8617.040	8617.060	150
Punched section with mounting flange 18 x 64 mm for the outer level, in the depth	4 pc(s).	8617.020	8617.020	8617.020	150
Punched section with mounting flange 23 x 64 mm for the inner level, in the width	4 pc(s).	8617.130	8617.140	8617.160	150
Punched section with mounting flange 23 x 64 mm for the inner level, in the depth	4 pc(s).	8617.120	8617.120	8617.120	150
Punched rail 18 x 39 mm for the enclosure depth	4 pc(s).	8617.710	8617.710	8617.710	151
Support strip for the enclosure depth	20 pc(s).	4695.000	4695.000	4695.000	152
C rail 30/15, for the enclosure width	6 pc(s).	4944.000	4945.000	4947.000	152
Support rail 48 x 26 mm, for the enclosure width	2 pc(s).	8617.800	8617.810	8617.830	152
LED system light		see page	see page	see page	163
Earth straps		see page	see page	see page	169
Cable entry plates		8619.800	8619.801	8619.803	182
	P. of	2 pc(s).	2 pc(s).	4 pc(s).	
Cable entry grommets	8 cables, max. Ø 13 mm	25 pc(s).	4316.000	4316.000	182
	3 cables, max. Ø 21 mm	25 pc(s).	4317.000	4317.000	182
	1 cable, max. Ø 47 mm	25 pc(s).	4318.000	4318.000	182
Connector grommets	10 pc(s).	4311.000	4311.000	4311.000	182
Section for cable entry, centre		8618.800	8618.801	8618.803	183
	P. of	2 pc(s).	2 pc(s).	4 pc(s).	
Section for cable entry, rear		8618.810	8618.811	8618.813	183
	P. of	2 pc(s).	2 pc(s).	4 pc(s).	
Cable duct		see page	see page	see page	186
Cable clamp rail, right angle section	2 pc(s).	8619.410	8619.420	8619.440	187

Baying enclosure system VX25

Basic enclosure, height 1400 mm, depth 500 mm

Width (B) mm	P. of	600	800	1200	Page
Height (H) mm		1400	1400	1400	
Depth (T) mm		500	500	500	
Mounting plate width (F) mm		499	699	1099	
Mounting plate height (G) mm		1296	1296	1296	
Model No.	1 pc(s).	8645.000	8845.000	8245.000	
Weight, approx. kg		86.0	107.5	163.5	
Product-specific scope of supply					
Door(s)		1	1	2	
Accessories					
Base/plinth corner pieces with base/plinth trim panel, front and rear, 100 mm	2 pc(s).	8620.002	8620.003	8620.007	85
Base/plinth trim panels, sides, 100 mm	2 pc(s).	8620.032	8620.032	8620.032	86
Base/plinth corner pieces with base/plinth trim panel, front and rear, 200 mm	2 pc(s).	8620.022	8620.023	8620.025	85
Base/plinth trim panels, sides, 200 mm	2 pc(s).	8620.042	8620.042	8620.042	86
Levelling feet	4 pc(s).	4612.000	4612.000	4612.000	91
Side panels, screw-fastened, sheet steel	2 pc(s).	8145.245	8145.245	8145.245	96
Divider panel	1 pc(s).	–	–	–	
Divider panel for module plates	1 pc(s).	–	–	–	
Baying bracket, internal	6 pc(s).	8617.500	8617.500	8617.500	106
Baying block, internal	6 pc(s).	8617.501	8617.501	8617.501	106
Baying connector, external	6 pc(s).	8617.502	8617.502	8617.502	106
Glazed door	1 pc(s).	–	–	–	
Comfort handle VX for lock inserts	1 pc(s).	8618.200	8618.200	8618.200	120
Comfort handle VX for lock inserts and padlock	1 pc(s).	8618.230	8618.230	8618.230	120
Comfort handle VX for semi-cylinder	1 pc(s).	8618.250	8618.250	8618.250	120
Comfort handle with security lock insert, lock E1	1 pc(s).	8618.240	8618.240	8618.240	120
Comfort handle VX for ASSA lock system	1 pc(s).	8618.270	8618.270	8618.270	120
Lock inserts		see page	see page	see page	121
180° hinges	4 pc(s).	8618.330	8618.330	8618.330	111
Punched section with mounting flange, 14 x 39 mm, for tubular door frame	4 pc(s).	8619.720	8619.730	8619.720	126
Wiring plan pocket, sheet steel, depth 35 mm	1 pc(s).	4116.500	4118.500	4116.500	127
Wiring plan pocket, sheet steel, depth 90 mm	1 pc(s).	4116.000	4118.000	4116.000	127
Door stay for escape routes	1 pc(s).	8618.400	8618.400	8618.400	128
Ride-up roller	10 pc(s).	8618.420	8618.420	8618.420	128
Mounting plate infill	1 pc(s).	–	–	–	
Punched section with mounting flange 18 x 64 mm for the outer level, in the width	4 pc(s).	8617.030	8617.040	8617.060	150
Punched section with mounting flange 18 x 64 mm for the outer level, in the depth	4 pc(s).	8617.020	8617.020	8617.020	150
Punched section with mounting flange 23 x 64 mm for the inner level, in the width	4 pc(s).	8617.130	8617.140	8617.160	150
Punched section with mounting flange 23 x 64 mm for the inner level, in the depth	4 pc(s).	8617.120	8617.120	8617.120	150
Punched rail 18 x 39 mm for the enclosure depth	4 pc(s).	8617.710	8617.710	8617.710	151
Support strip for the enclosure depth	20 pc(s).	4695.000	4695.000	4695.000	152
C rail 30/15, for the enclosure width	6 pc(s).	4944.000	4945.000	4947.000	152
Support rail 48 x 26 mm, for the enclosure width	2 pc(s).	8617.800	8617.810	8617.830	152
LED system light		see page	see page	see page	163
Earth straps		see page	see page	see page	169
Cable entry plates		8619.800	8619.801	8619.803	182
	P. of	2 pc(s).	2 pc(s).	4 pc(s).	
Cable entry grommets	8 cables, max. Ø 13 mm	25 pc(s).	4316.000	4316.000	182
	3 cables, max. Ø 21 mm	25 pc(s).	4317.000	4317.000	182
	1 cable, max. Ø 47 mm	25 pc(s).	4318.000	4318.000	182
Connector grommets	10 pc(s).	4311.000	4311.000	4311.000	182
Section for cable entry, centre		8618.800	8618.801	8618.803	183
	P. of	2 pc(s).	2 pc(s).	4 pc(s).	
Section for cable entry, rear		8618.810	8618.811	8618.813	183
	P. of	2 pc(s).	2 pc(s).	4 pc(s).	
Cable duct		see page	see page	see page	186
Cable clamp rail, right angle section	2 pc(s).	8619.410	8619.420	8619.440	187

Baying enclosure system VX25

Basic enclosure, height 1600 mm, depth 500 mm

Width (B) mm	P. of	600	800	1200	Page
Height (H) mm		1600	1600	1600	
Depth (T) mm		500	500	500	
Mounting plate width (F) mm		499	699	1099	
Mounting plate height (G) mm		1496	1496	1496	
Model No.	1 pc(s).	8665.000	8865.000	8265.000	
Weight, approx. kg		100.0	103.0	159.3	
Product-specific scope of supply					
Door(s)		1	1	2	
Accessories					
Base/plinth corner pieces with base/plinth trim panel, front and rear, 100 mm	2 pc(s).	8620.002	8620.003	8620.007	85
Base/plinth trim panels, sides, 100 mm	2 pc(s).	8620.032	8620.032	8620.032	86
Base/plinth corner pieces with base/plinth trim panel, front and rear, 200 mm	2 pc(s).	8620.022	8620.023	8620.025	85
Base/plinth trim panels, sides, 200 mm	2 pc(s).	8620.042	8620.042	8620.042	86
Levelling feet	4 pc(s).	4612.000	4612.000	4612.000	91
Side panels, screw-fastened, sheet steel	2 pc(s).	8165.245	8165.245	8165.245	96
Divider panel	1 pc(s).	–	–	–	
Divider panel for module plates	1 pc(s).	–	–	–	
Baying bracket, internal	6 pc(s).	8617.500	8617.500	8617.500	106
Baying block, internal	6 pc(s).	8617.501	8617.501	8617.501	106
Baying connector, external	6 pc(s).	8617.502	8617.502	8617.502	106
Glazed door	1 pc(s).	–	–	–	
Comfort handle VX for lock inserts	1 pc(s).	8618.200	8618.200	8618.200	120
Comfort handle VX for lock inserts and padlock	1 pc(s).	8618.230	8618.230	8618.230	120
Comfort handle VX for semi-cylinder	1 pc(s).	8618.250	8618.250	8618.250	120
Comfort handle with security lock insert, lock E1	1 pc(s).	8618.240	8618.240	8618.240	120
Comfort handle VX for ASSA lock system	1 pc(s).	8618.270	8618.270	8618.270	120
Lock inserts		see page	see page	see page	121
180° hinges	4 pc(s).	8618.330	8618.330	8618.330	111
Punched section with mounting flange, 14 x 39 mm, for tubular door frame	4 pc(s).	8619.720	8619.730	8619.720	126
Wiring plan pocket, sheet steel, depth 35 mm	1 pc(s).	4116.500	4118.500	4116.500	127
Wiring plan pocket, sheet steel, depth 90 mm	1 pc(s).	4116.000	4118.000	4116.000	127
Door stay for escape routes	1 pc(s).	8618.400	8618.400	8618.400	128
Ride-up roller	10 pc(s).	8618.420	8618.420	8618.420	128
Mounting plate infill	1 pc(s).	–	–	–	
Punched section with mounting flange 18 x 64 mm for the outer level, in the width	4 pc(s).	8617.030	8617.040	8617.060	150
Punched section with mounting flange 18 x 64 mm for the outer level, in the depth	4 pc(s).	8617.020	8617.020	8617.020	150
Punched section with mounting flange 23 x 64 mm for the inner level, in the width	4 pc(s).	8617.130	8617.140	8617.160	150
Punched section with mounting flange 23 x 64 mm for the inner level, in the depth	4 pc(s).	8617.120	8617.120	8617.120	150
Punched rail 18 x 39 mm for the enclosure depth	4 pc(s).	8617.710	8617.710	8617.710	151
Support strip for the enclosure depth	20 pc(s).	4695.000	4695.000	4695.000	152
C rail 30/15, for the enclosure width	6 pc(s).	4944.000	4945.000	4947.000	152
Support rail 48 x 26 mm, for the enclosure width	2 pc(s).	8617.800	8617.810	8617.830	152
LED system light		see page	see page	see page	163
Earth straps		see page	see page	see page	169
Cable entry plates		8619.800	8619.801	8619.803	182
	P. of	2 pc(s).	2 pc(s).	4 pc(s).	
Cable entry grommets	8 cables, max. Ø 13 mm	25 pc(s).	4316.000	4316.000	182
	3 cables, max. Ø 21 mm	25 pc(s).	4317.000	4317.000	182
	1 cable, max. Ø 47 mm	25 pc(s).	4318.000	4318.000	182
Connector grommets	10 pc(s).	4311.000	4311.000	4311.000	182
Section for cable entry, centre		8618.800	8618.801	8618.803	183
	P. of	2 pc(s).	2 pc(s).	4 pc(s).	
Section for cable entry, rear		8618.810	8618.811	8618.813	183
	P. of	2 pc(s).	2 pc(s).	4 pc(s).	
Cable duct		see page	see page	see page	186
Cable clamp rail, right angle section	2 pc(s).	8619.410	8619.420	8619.440	187

Baying enclosure system VX25

Basic enclosure, height 1800 mm, depth 400 mm

Width (B) mm	P. of	600	800	1000	1000	1200	Page
Height (H) mm		1800	1800	1800	1800	1800	
Depth (T) mm		400	400	400	400	400	
Mounting plate width (F) mm		499	699	899	899	1099	
Mounting plate height (G) mm		1696	1696	1696	1696	1696	
Model No.	1 pc(s).	8684.000	8884.000	8080.000	8084.000	8284.000	
Weight, approx. kg		91.3	113.5	136.4	140.0	170.1	
Product-specific scope of supply							
Door(s)		1	1	2	1	2	
Accessories							
Base/plinth corner pieces with base/plinth trim panel, front and rear, 100 mm	2 pc(s).	8620.002	8620.003	8620.005	8620.005	8620.007	85
Base/plinth trim panels, sides, 100 mm	2 pc(s).	8620.031	8620.031	8620.031	8620.031	8620.031	86
Base/plinth corner pieces with base/plinth trim panel, front and rear, 200 mm	2 pc(s).	8620.022	8620.023	8620.024	8620.024	8620.025	85
Base/plinth trim panels, sides, 200 mm	2 pc(s).	8620.041	8620.041	8620.041	8620.041	8620.041	86
Levelling feet	4 pc(s).	4612.000	4612.000	4612.000	4612.000	4612.000	91
Side panels, screw-fastened, sheet steel	2 pc(s).	8184.245	8184.245	8184.245	8184.245	8184.245	96
Divider panel	1 pc(s).	8609.200	8609.200	8609.200	8609.200	8609.200	98
Divider panel for module plates	1 pc(s).	–	–	–	–	–	
Baying bracket, internal	6 pc(s).	8617.500	8617.500	8617.500	8617.500	8617.500	106
Baying block, internal	6 pc(s).	8617.501	8617.501	8617.501	8617.501	8617.501	106
Baying connector, external	6 pc(s).	8617.502	8617.502	8617.502	8617.502	8617.502	106
Glazed door	1 pc(s).	8618.000	8618.010	–	–	–	110
Comfort handle VX for lock inserts	1 pc(s).	8618.200	8618.200	8618.200	8618.200	8618.200	120
Comfort handle VX for lock inserts and padlock	1 pc(s).	8618.230	8618.230	8618.230	8618.230	8618.230	120
Comfort handle VX for semi-cylinder	1 pc(s).	8618.250	8618.250	8618.250	8618.250	8618.250	120
Comfort handle with security lock insert, lock E1	1 pc(s).	8618.240	8618.240	8618.240	8618.240	8618.240	120
Comfort handle VX for ASSA lock system	1 pc(s).	8618.270	8618.270	8618.270	8618.270	8618.270	120
Lock inserts		see page	see page	see page	see page	see page	121
180° hinges	4 pc(s).	8618.330	8618.330	8618.330	8618.330	8618.330	111
Punched section with mounting flange, 14 x 39 mm, for tubular door frame	4 pc(s).	8619.720	8619.730	8619.710	8619.750	8619.720	126
Wiring plan pocket, sheet steel, depth 35 mm	1 pc(s).	4116.500	4118.500	4115.500	–	4116.500	127
Wiring plan pocket, sheet steel, depth 90 mm	1 pc(s).	4116.000	4118.000	4115.000	4124.000	4116.000	127
Door stay for escape routes	1 pc(s).	8618.400	8618.400	8618.400	8618.400	8618.400	128
Ride-up roller	10 pc(s).	8618.420	8618.420	8618.420	8618.420	8618.420	128
Mounting plate infill	1 pc(s).	4590.700	4590.700	4590.700	4590.700	4590.700	141
Punched section with mounting flange 18 x 64 mm for the outer level, in the width	4 pc(s).	8617.030	8617.040	8617.050	8617.050	8617.060	150
Punched section with mounting flange 18 x 64 mm for the outer level, in the depth	4 pc(s).	8617.010	8617.010	8617.010	8617.010	8617.010	150
Punched section with mounting flange 23 x 64 mm for the inner level, in the width	4 pc(s).	8617.130	8617.140	8617.150	8617.150	8617.160	150
Punched section with mounting flange 23 x 64 mm for the inner level, in the depth	4 pc(s).	8617.110	8617.110	8617.110	8617.110	8617.110	150
Punched rail 18 x 39 mm for the enclosure depth	4 pc(s).	8617.700	8617.700	8617.700	8617.700	8617.700	151
Support strip for the enclosure depth	20 pc(s).	4694.000	4694.000	4694.000	4694.000	4694.000	152
C rail 30/15, for the enclosure width	6 pc(s).	4944.000	4945.000	4946.000	4946.000	4947.000	152
Support rail 48 x 26 mm, for the enclosure width	2 pc(s).	8617.800	8617.810	8617.820	8617.820	8617.830	152
LED system light		see page	see page	see page	see page	see page	163
Earth straps		see page	see page	see page	see page	see page	169
Cable entry plates		8619.800	8619.801	8619.802	8619.802	8619.803	182
	P. of	2 pc(s).	2 pc(s).	4 pc(s).	4 pc(s).	4 pc(s).	
Cable entry grommets	8 cables, max. Ø 13 mm	25 pc(s).	4316.000	4316.000	4316.000	4316.000	182
	3 cables, max. Ø 21 mm	25 pc(s).	4317.000	4317.000	4317.000	4317.000	182
	1 cable, max. Ø 47 mm	25 pc(s).	4318.000	4318.000	4318.000	4318.000	182
Connector grommets	10 pc(s).	4311.000	4311.000	4311.000	4311.000	4311.000	182
Section for cable entry, centre		8618.800	8618.801	8618.802	8618.802	8618.803	183
	P. of	2 pc(s).	2 pc(s).	4 pc(s).	4 pc(s).	4 pc(s).	
Section for cable entry, rear		8618.810	8618.811	8618.812	8618.812	8618.813	183
	P. of	2 pc(s).	2 pc(s).	4 pc(s).	4 pc(s).	4 pc(s).	
Cable duct		see page	see page	see page	see page	see page	186
Cable clamp rail, right angle section	2 pc(s).	8619.410	8619.420	8619.430	8619.430	8619.440	187

Baying enclosure system VX25

Basic enclosure, height 1800 mm, depth 500 mm

Width (B) mm	P. of	400	600	800	800	1200	Page
Height (H) mm		1800	1800	1800	1800	1800	
Depth (T) mm		500	500	500	500	500	
Mounting plate width (F) mm		299	499	699	699	1099	
Mounting plate height (G) mm		1696	1696	1696	1696	1696	
Model No.	1 pc(s).	8485.000	8685.000	8880.000	8885.000	8285.000	
Weight, approx. kg		49.2	93.8	122.5	115.8	173.3	
Product-specific scope of supply							
Door(s)		1	1	2	1	2	
Accessories							
Base/plinth corner pieces with base/plinth trim panel, front and rear, 100 mm	2 pc(s).	8620.001	8620.002	8620.003	8620.003	8620.007	85
Base/plinth trim panels, sides, 100 mm	2 pc(s).	8620.032	8620.032	8620.032	8620.032	8620.032	86
Base/plinth corner pieces with base/plinth trim panel, front and rear, 200 mm	2 pc(s).	8620.021	8620.022	8620.023	8620.023	8620.025	85
Base/plinth trim panels, sides, 200 mm	2 pc(s).	8620.042	8620.042	8620.042	8620.042	8620.042	86
Levelling feet	4 pc(s).	4612.000	4612.000	4612.000	4612.000	4612.000	91
Side panels, screw-fastened, sheet steel	2 pc(s).	8185.245	8185.245	8185.245	8185.245	8185.245	96
Divider panel	1 pc(s).	8609.201	8609.201	8609.201	8609.201	8609.201	98
Divider panel for module plates	1 pc(s).	8609.210	8609.210	8609.210	8609.210	8609.210	99
Baying bracket, internal	6 pc(s).	8617.500	8617.500	8617.500	8617.500	8617.500	106
Baying block, internal	6 pc(s).	8617.501	8617.501	8617.501	8617.501	8617.501	106
Baying connector, external	6 pc(s).	8617.502	8617.502	8617.502	8617.502	8617.502	106
Glazed door	1 pc(s).	–	8618.000	–	8618.010	–	110
Comfort handle VX for lock inserts	1 pc(s).	8618.200	8618.200	8618.200	8618.200	8618.200	120
Comfort handle VX for lock inserts and padlock	1 pc(s).	8618.230	8618.230	8618.230	8618.230	8618.230	120
Comfort handle VX for semi-cylinder	1 pc(s).	8618.250	8618.250	8618.250	8618.250	8618.250	120
Comfort handle with security lock insert, lock E1	1 pc(s).	8618.240	8618.240	8618.240	8618.240	8618.240	120
Comfort handle VX for ASSA lock system	1 pc(s).	8618.270	8618.270	8618.270	8618.270	8618.270	120
Lock inserts		see page	see page	see page	see page	see page	121
180° hinges	4 pc(s).	8618.330	8618.330	8618.330	8618.330	8618.330	111
Punched section with mounting flange, 14 x 39 mm, for tubular door frame	4 pc(s).	8619.700	8619.720	8619.700	8619.730	8619.720	126
Wiring plan pocket, sheet steel, depth 35 mm	1 pc(s).	–	4116.500	–	4118.500	4116.500	127
Wiring plan pocket, sheet steel, depth 90 mm	1 pc(s).	4114.000	4116.000	4114.000	4118.000	4116.000	127
Door stay for escape routes	1 pc(s).	8618.400	8618.400	8618.400	8618.400	8618.400	128
Ride-up roller	10 pc(s).	8618.420	8618.420	8618.420	8618.420	8618.420	128
Mounting plate infill	1 pc(s).	4590.700	4590.700	4590.700	4590.700	4590.700	141
Punched section with mounting flange 18 x 64 mm for the outer level, in the width	4 pc(s).	8617.010	8617.030	8617.040	8617.040	8617.060	150
Punched section with mounting flange 18 x 64 mm for the outer level, in the depth	4 pc(s).	8617.020	8617.020	8617.020	8617.020	8617.020	150
Punched section with mounting flange 23 x 64 mm for the inner level, in the width	4 pc(s).	8617.110	8617.130	8617.140	8617.140	8617.160	150
Punched section with mounting flange 23 x 64 mm for the inner level, in the depth	4 pc(s).	8617.120	8617.120	8617.120	8617.120	8617.120	150
Punched rail 18 x 39 mm for the enclosure depth	4 pc(s).	8617.710	8617.710	8617.710	8617.710	8617.710	151
Support strip for the enclosure depth	20 pc(s).	4695.000	4695.000	4695.000	4695.000	4695.000	152
C rail 30/15, for the enclosure width	6 pc(s).	–	4944.000	4945.000	4945.000	4947.000	152
Support rail 48 x 26 mm, for the enclosure width	2 pc(s).	–	8617.800	8617.810	8617.810	8617.830	152
LED system light		see page	see page	see page	see page	see page	163
Earth straps		see page	see page	see page	see page	see page	169
Cable entry plates		–	8619.800	8619.801	8619.801	8619.803	182
	P. of	–	2 pc(s).	2 pc(s).	2 pc(s).	4 pc(s).	
Cable entry grommets	8 cables, max. Ø 13 mm	25 pc(s).	4316.000	4316.000	4316.000	4316.000	182
	3 cables, max. Ø 21 mm	25 pc(s).	4317.000	4317.000	4317.000	4317.000	182
	1 cable, max. Ø 47 mm	25 pc(s).	4318.000	4318.000	4318.000	4318.000	182
Connector grommets	10 pc(s).	4311.000	4311.000	4311.000	4311.000	4311.000	182
Section for cable entry, centre		–	8618.800	8618.801	8618.801	8618.803	183
	P. of	–	2 pc(s).	2 pc(s).	2 pc(s).	4 pc(s).	
Section for cable entry, rear		–	8618.810	8618.811	8618.811	8618.813	183
	P. of	–	2 pc(s).	2 pc(s).	2 pc(s).	4 pc(s).	
Cable duct		see page	see page	see page	see page	see page	186
Cable clamp rail, right angle section	2 pc(s).	8619.400	8619.410	8619.420	8619.420	8619.440	187

Baying enclosure system VX25

Basic enclosure, height 1800 mm, depth 600 mm

Width (B) mm	P. of	400	600	800	800	1200	Page
Height (H) mm		1800	1800	1800	1800	1800	
Depth (T) mm		600	600	600	600	600	
Mounting plate width (F) mm		299	499	699	699	1099	
Mounting plate height (G) mm		1696	1696	1696	1696	1696	
Model No.	1 pc(s).	8486.000	8686.000	8881.000	8886.000	8286.000	
Weight, approx. kg		51.7	96.8	120.3	125.8	179.9	
Product-specific scope of supply							
Door(s)		1	1	2	1	2	
Accessories							
Base/plinth corner pieces with base/plinth trim panel, front and rear, 100 mm	2 pc(s).	8620.001	8620.002	8620.003	8620.003	8620.007	85
Base/plinth trim panels, sides, 100 mm	2 pc(s).	8620.033	8620.033	8620.033	8620.033	8620.033	86
Base/plinth corner pieces with base/plinth trim panel, front and rear, 200 mm	2 pc(s).	8620.021	8620.022	8620.023	8620.023	8620.025	85
Base/plinth trim panels, sides, 200 mm	2 pc(s).	8620.043	8620.043	8620.043	8620.043	8620.043	86
Levelling feet	4 pc(s).	4612.000	4612.000	4612.000	4612.000	4612.000	91
Side panels, screw-fastened, sheet steel	2 pc(s).	8186.245	8186.245	8186.245	8186.245	8186.245	96
Divider panel	1 pc(s).	8609.202	8609.202	8609.202	8609.202	8609.202	98
Divider panel for module plates	1 pc(s).	8609.211	8609.211	8609.211	8609.211	8609.211	99
Baying bracket, internal	6 pc(s).	8617.500	8617.500	8617.500	8617.500	8617.500	106
Baying block, internal	6 pc(s).	8617.501	8617.501	8617.501	8617.501	8617.501	106
Baying connector, external	6 pc(s).	8617.502	8617.502	8617.502	8617.502	8617.502	106
Glazed door	1 pc(s).	–	8618.000	–	8618.010	–	110
Comfort handle VX for lock inserts	1 pc(s).	8618.200	8618.200	8618.200	8618.200	8618.200	120
Comfort handle VX for lock inserts and padlock	1 pc(s).	8618.230	8618.230	8618.230	8618.230	8618.230	120
Comfort handle VX for semi-cylinder	1 pc(s).	8618.250	8618.250	8618.250	8618.250	8618.250	120
Comfort handle with security lock insert, lock E1	1 pc(s).	8618.240	8618.240	8618.240	8618.240	8618.240	120
Comfort handle VX for ASSA lock system	1 pc(s).	8618.270	8618.270	8618.270	8618.270	8618.270	120
Lock inserts		see page	see page	see page	see page	see page	121
180° hinges	4 pc(s).	8618.330	8618.330	8618.330	8618.330	8618.330	111
Punched section with mounting flange, 14 x 39 mm, for tubular door frame	4 pc(s).	8619.700	8619.720	8619.700	8619.730	8619.720	126
Wiring plan pocket, sheet steel, depth 35 mm	1 pc(s).	–	4116.500	–	4118.500	4116.500	127
Wiring plan pocket, sheet steel, depth 90 mm	1 pc(s).	4114.000	4116.000	4114.000	4118.000	4116.000	127
Door stay for escape routes	1 pc(s).	8618.400	8618.400	8618.400	8618.400	8618.400	128
Ride-up roller	10 pc(s).	8618.420	8618.420	8618.420	8618.420	8618.420	128
Mounting plate infill	1 pc(s).	4590.700	4590.700	4590.700	4590.700	4590.700	141
Punched section with mounting flange 18 x 64 mm for the outer level, in the width	4 pc(s).	8617.010	8617.030	8617.040	8617.040	8617.060	150
Punched section with mounting flange 18 x 64 mm for the outer level, in the depth	4 pc(s).	8617.030	8617.030	8617.030	8617.030	8617.030	150
Punched section with mounting flange 23 x 64 mm for the inner level, in the width	4 pc(s).	8617.110	8617.130	8617.140	8617.140	8617.160	150
Punched section with mounting flange 23 x 64 mm for the inner level, in the depth	4 pc(s).	8617.130	8617.130	8617.130	8617.130	8617.130	150
Punched rail 18 x 39 mm for the enclosure depth	4 pc(s).	8617.720	8617.720	8617.720	8617.720	8617.720	151
Support strip for the enclosure depth	20 pc(s).	4696.000	4696.000	4696.000	4696.000	4696.000	152
C rail 30/15, for the enclosure width	6 pc(s).	–	4944.000	4945.000	4945.000	4947.000	152
Support rail 48 x 26 mm, for the enclosure width	2 pc(s).	–	8617.800	8617.810	8617.810	8617.830	152
LED system light		see page	see page	see page	see page	see page	163
Earth straps		see page	see page	see page	see page	see page	169
Cable entry plates		–	8619.800	8619.801	8619.801	8619.803	182
	P. of	–	2 pc(s).	2 pc(s).	2 pc(s).	4 pc(s).	
Cable entry grommets	8 cables, max. Ø 13 mm	25 pc(s).	4316.000	4316.000	4316.000	4316.000	182
	3 cables, max. Ø 21 mm	25 pc(s).	4317.000	4317.000	4317.000	4317.000	182
	1 cable, max. Ø 47 mm	25 pc(s).	4318.000	4318.000	4318.000	4318.000	182
Connector grommets	10 pc(s).	4311.000	4311.000	4311.000	4311.000	4311.000	182
Section for cable entry, centre		–	8618.800	8618.801	8618.801	8618.803	183
	P. of	–	2 pc(s).	2 pc(s).	2 pc(s).	4 pc(s).	
Section for cable entry, rear		–	8618.810	8618.811	8618.811	8618.813	183
	P. of	–	2 pc(s).	2 pc(s).	2 pc(s).	4 pc(s).	
Cable duct		see page	see page	see page	see page	see page	186
Cable clamp rail, right angle section	2 pc(s).	8619.400	8619.410	8619.420	8619.420	8619.440	187

Baying enclosure system VX25

Basic enclosure, height 2000 mm, depth 400 mm

Width (B) mm	P. of	600	800	1000	1200	Page
Height (H) mm		2000	2000	2000	2000	
Depth (T) mm		400	400	400	400	
Mounting plate width (F) mm		499	699	899	1099	
Mounting plate height (G) mm		1896	1896	1896	1896	
Model No.	1 pc(s).	8604.000	8804.000	8004.000	8204.000	
Weight, approx. kg		99.0	124.0	152.8	184.5	
Product-specific scope of supply						
Door(s)		1	1	2	2	
Accessories						
Base/plinth corner pieces with base/plinth trim panel, front and rear, 100 mm	2 pc(s).	8620.002	8620.003	8620.005	8620.007	85
Base/plinth trim panels, sides, 100 mm	2 pc(s).	8620.031	8620.031	8620.031	8620.031	86
Base/plinth corner pieces with base/plinth trim panel, front and rear, 200 mm	2 pc(s).	8620.022	8620.023	8620.024	8620.025	85
Base/plinth trim panels, sides, 200 mm	2 pc(s).	8620.041	8620.041	8620.041	8620.041	86
Levelling feet	4 pc(s).	4612.000	4612.000	4612.000	4612.000	91
Side panels, screw-fastened, sheet steel	2 pc(s).	8104.245	8104.245	8104.245	8104.245	96
Divider panel	1 pc(s).	8609.203	8609.203	8609.203	8609.203	98
Divider panel for module plates	1 pc(s).	–	–	–	–	
Baying bracket, internal	6 pc(s).	8617.500	8617.500	8617.500	8617.500	106
Baying block, internal	6 pc(s).	8617.501	8617.501	8617.501	8617.501	106
Baying connector, external	6 pc(s).	8617.502	8617.502	8617.502	8617.502	106
Glazed door	1 pc(s).	8618.020	8618.030	–	–	110
Comfort handle VX for lock inserts	1 pc(s).	8618.200	8618.200	8618.200	8618.200	120
Comfort handle VX for lock inserts and padlock	1 pc(s).	8618.230	8618.230	8618.230	8618.230	120
Comfort handle VX for semi-cylinder	1 pc(s).	8618.250	8618.250	8618.250	8618.250	120
Comfort handle with security lock insert, lock E1	1 pc(s).	8618.240	8618.240	8618.240	8618.240	120
Comfort handle VX for ASSA lock system	1 pc(s).	8618.270	8618.270	8618.270	8618.270	120
Lock inserts		see page	see page	see page	see page	121
180° hinges	4 pc(s).	8618.330	8618.330	8618.330	8618.330	111
Punched section with mounting flange, 14 x 39 mm, for tubular door frame	4 pc(s).	8619.720	8619.730	8619.710	8619.720	126
Wiring plan pocket, sheet steel, depth 35 mm	1 pc(s).	4116.500	4118.500	4115.500	4116.500	127
Wiring plan pocket, sheet steel, depth 90 mm	1 pc(s).	4116.000	4118.000	4115.000	4116.000	127
Door stay for escape routes	1 pc(s).	8618.400	8618.400	8618.400	8618.400	128
Ride-up roller	10 pc(s).	8618.420	8618.420	8618.420	8618.420	128
Mounting plate infill	1 pc(s).	4591.700	4591.700	4591.700	4591.700	141
Punched section with mounting flange 18 x 64 mm for the outer level, in the width	4 pc(s).	8617.030	8617.040	8617.050	8617.060	150
Punched section with mounting flange 18 x 64 mm for the outer level, in the depth	4 pc(s).	8617.010	8617.010	8617.010	8617.010	150
Punched section with mounting flange 23 x 64 mm for the inner level, in the width	4 pc(s).	8617.130	8617.140	8617.150	8617.160	150
Punched section with mounting flange 23 x 64 mm for the inner level, in the depth	4 pc(s).	8617.110	8617.110	8617.110	8617.110	150
Punched rail 18 x 39 mm for the enclosure depth	4 pc(s).	8617.700	8617.700	8617.700	8617.700	151
Support strip for the enclosure depth	20 pc(s).	4694.000	4694.000	4694.000	4694.000	152
C rail 30/15, for the enclosure width	6 pc(s).	4944.000	4945.000	4946.000	4947.000	152
Support rail 48 x 26 mm, for the enclosure width	2 pc(s).	8617.800	8617.810	8617.820	8617.830	152
LED system light		see page	see page	see page	see page	163
Earth straps		see page	see page	see page	see page	169
Cable entry plates		8619.800	8619.801	8619.802	8619.803	182
	P. of	2 pc(s).	2 pc(s).	4 pc(s).	4 pc(s).	
Cable entry grommets	8 cables, max. Ø 13 mm	25 pc(s).	4316.000	4316.000	4316.000	182
	3 cables, max. Ø 21 mm	25 pc(s).	4317.000	4317.000	4317.000	182
	1 cable, max. Ø 47 mm	25 pc(s).	4318.000	4318.000	4318.000	182
Connector grommets	10 pc(s).	4311.000	4311.000	4311.000	4311.000	182
Section for cable entry, centre		8618.800	8618.801	8618.802	8618.803	183
	P. of	2 pc(s).	2 pc(s).	4 pc(s).	4 pc(s).	
Section for cable entry, rear		8618.810	8618.811	8618.812	8618.813	183
	P. of	2 pc(s).	2 pc(s).	4 pc(s).	4 pc(s).	
Cable duct		see page	see page	see page	see page	186
Cable clamp rail, right angle section	2 pc(s).	8619.410	8619.420	8619.430	8619.440	187

Baying enclosure system VX25

Basic enclosure, height 2000 mm, depth 500 mm

Width (B) mm	P. of	400	600	800	1000	1200	Page
Height (H) mm		2000	2000	2000	2000	2000	
Depth (T) mm		500	500	500	500	500	
Mounting plate width (F) mm		299	499	699	899	1099	
Mounting plate height (G) mm		1896	1896	1896	1896	1896	
Model No.	1 pc(s).	8405.000	8605.000	8805.000	8005.000	8205.000	
Weight, approx. kg		60.7	101.3	126.3	157.1	190.6	
Product-specific scope of supply							
Door(s)		1	1	1	2	2	
Accessories							
Base/plinth corner pieces with base/plinth trim panel, front and rear, 100 mm	2 pc(s).	8620.001	8620.002	8620.003	8620.005	8620.007	85
Base/plinth trim panels, sides, 100 mm	2 pc(s).	8620.032	8620.032	8620.032	8620.032	8620.032	86
Base/plinth corner pieces with base/plinth trim panel, front and rear, 200 mm	2 pc(s).	8620.021	8620.022	8620.023	8620.024	8620.025	85
Base/plinth trim panels, sides, 200 mm	2 pc(s).	8620.042	8620.042	8620.042	8620.042	8620.042	86
Levelling feet	4 pc(s).	4612.000	4612.000	4612.000	4612.000	4612.000	91
Side panels, screw-fastened, sheet steel	2 pc(s).	8105.245	8105.245	8105.245	8105.245	8105.245	96
Divider panel	1 pc(s).	8609.204	8609.204	8609.204	8609.204	8609.204	98
Divider panel for module plates	1 pc(s).	8609.212	8609.212	8609.212	8609.212	8609.212	99
Baying bracket, internal	6 pc(s).	8617.500	8617.500	8617.500	8617.500	8617.500	106
Baying block, internal	6 pc(s).	8617.501	8617.501	8617.501	8617.501	8617.501	106
Baying connector, external	6 pc(s).	8617.502	8617.502	8617.502	8617.502	8617.502	106
Glazed door	1 pc(s).	–	8618.020	8618.030	–	–	110
Comfort handle VX for lock inserts	1 pc(s).	8618.200	8618.200	8618.200	8618.200	8618.200	120
Comfort handle VX for lock inserts and padlock	1 pc(s).	8618.230	8618.230	8618.230	8618.230	8618.230	120
Comfort handle VX for semi-cylinder	1 pc(s).	8618.250	8618.250	8618.250	8618.250	8618.250	120
Comfort handle with security lock insert, lock E1	1 pc(s).	8618.240	8618.240	8618.240	8618.240	8618.240	120
Comfort handle VX for ASSA lock system	1 pc(s).	8618.270	8618.270	8618.270	8618.270	8618.270	120
Lock inserts		see page	see page	see page	see page	see page	121
180° hinges	4 pc(s).	8618.330	8618.330	8618.330	8618.330	8618.330	111
Punched section with mounting flange, 14 x 39 mm, for tubular door frame	4 pc(s).	8619.700	8619.720	8619.730	8619.710	8619.720	126
Wiring plan pocket, sheet steel, depth 35 mm	1 pc(s).	–	4116.500	4118.500	4115.500	4116.500	127
Wiring plan pocket, sheet steel, depth 90 mm	1 pc(s).	4114.000	4116.000	4118.000	4115.000	4116.000	127
Door stay for escape routes	1 pc(s).	8618.400	8618.400	8618.400	8618.400	8618.400	128
Ride-up roller	10 pc(s).	8618.420	8618.420	8618.420	8618.420	8618.420	128
Mounting plate infill	1 pc(s).	4591.700	4591.700	4591.700	4591.700	4591.700	141
Punched section with mounting flange 18 x 64 mm for the outer level, in the width	4 pc(s).	8617.010	8617.030	8617.040	8617.050	8617.060	150
Punched section with mounting flange 18 x 64 mm for the outer level, in the depth	4 pc(s).	8617.020	8617.020	8617.020	8617.020	8617.020	150
Punched section with mounting flange 23 x 64 mm for the inner level, in the width	4 pc(s).	8617.110	8617.130	8617.140	8617.150	8617.160	150
Punched section with mounting flange 23 x 64 mm for the inner level, in the depth	4 pc(s).	8617.120	8617.120	8617.120	8617.120	8617.120	150
Punched rail 18 x 39 mm for the enclosure depth	4 pc(s).	8617.710	8617.710	8617.710	8617.710	8617.710	151
Support strip for the enclosure depth	20 pc(s).	4695.000	4695.000	4695.000	4695.000	4695.000	152
C rail 30/15, for the enclosure width	6 pc(s).	–	4944.000	4945.000	4946.000	4947.000	152
Support rail 48 x 26 mm, for the enclosure width	2 pc(s).	–	8617.800	8617.810	8617.820	8617.830	152
LED system light		see page	see page	see page	see page	see page	163
Earth straps		see page	see page	see page	see page	see page	169
Cable entry plates		–	8619.800	8619.801	8619.802	8619.803	182
	P. of	–	2 pc(s).	2 pc(s).	4 pc(s).	4 pc(s).	
Cable entry grommets	8 cables, max. Ø 13 mm	25 pc(s).	4316.000	4316.000	4316.000	4316.000	182
	3 cables, max. Ø 21 mm	25 pc(s).	4317.000	4317.000	4317.000	4317.000	182
	1 cable, max. Ø 47 mm	25 pc(s).	4318.000	4318.000	4318.000	4318.000	182
Connector grommets	10 pc(s).	4311.000	4311.000	4311.000	4311.000	4311.000	182
Section for cable entry, centre		–	8618.800	8618.801	8618.802	8618.803	183
	P. of	–	2 pc(s).	2 pc(s).	4 pc(s).	4 pc(s).	
Section for cable entry, rear		–	8618.810	8618.811	8618.812	8618.813	183
	P. of	–	2 pc(s).	2 pc(s).	4 pc(s).	4 pc(s).	
Cable duct		see page	see page	see page	see page	see page	186
Cable clamp rail, right angle section	2 pc(s).	8619.400	8619.410	8619.420	8619.430	8619.440	187

Baying enclosure system VX25

Basic enclosure, height 2000 mm, depth 600 mm

Width (B) mm	P. of	400	600	800	1000	1200	Page
Height (H) mm		2000	2000	2000	2000	2000	
Depth (T) mm		600	600	600	600	600	
Mounting plate width (F) mm		299	499	699	899	1099	
Mounting plate height (G) mm		1896	1896	1896	1896	1896	
Model No.	1 pc(s).	8406.000	8606.000	8806.000	8006.000	8206.000	
Weight, approx. kg		55.7	104.0	130.5	161.2	194.6	
Product-specific scope of supply							
Door(s)		1	1	1	2	2	
Accessories							
Base/plinth corner pieces with base/plinth trim panel, front and rear, 100 mm	2 pc(s).	8620.001	8620.002	8620.003	8620.005	8620.007	85
Base/plinth trim panels, sides, 100 mm	2 pc(s).	8620.033	8620.033	8620.033	8620.033	8620.033	86
Base/plinth corner pieces with base/plinth trim panel, front and rear, 200 mm	2 pc(s).	8620.021	8620.022	8620.023	8620.024	8620.025	85
Base/plinth trim panels, sides, 200 mm	2 pc(s).	8620.043	8620.043	8620.043	8620.043	8620.043	86
Levelling feet	4 pc(s).	4612.000	4612.000	4612.000	4612.000	4612.000	91
Side panels, screw-fastened, sheet steel	2 pc(s).	8106.245	8106.245	8106.245	8106.245	8106.245	96
Divider panel	1 pc(s).	8609.205	8609.205	8609.205	8609.205	8609.205	98
Divider panel for module plates	1 pc(s).	8609.213	8609.213	8609.213	8609.213	8609.213	99
Baying bracket, internal	6 pc(s).	8617.500	8617.500	8617.500	8617.500	8617.500	106
Baying block, internal	6 pc(s).	8617.501	8617.501	8617.501	8617.501	8617.501	106
Baying connector, external	6 pc(s).	8617.502	8617.502	8617.502	8617.502	8617.502	106
Glazed door	1 pc(s).	–	8618.020	8618.030	–	–	110
Comfort handle VX for lock inserts	1 pc(s).	8618.200	8618.200	8618.200	8618.200	8618.200	120
Comfort handle VX for lock inserts and padlock	1 pc(s).	8618.230	8618.230	8618.230	8618.230	8618.230	120
Comfort handle VX for semi-cylinder	1 pc(s).	8618.250	8618.250	8618.250	8618.250	8618.250	120
Comfort handle with security lock insert, lock E1	1 pc(s).	8618.240	8618.240	8618.240	8618.240	8618.240	120
Comfort handle VX for ASSA lock system	1 pc(s).	8618.270	8618.270	8618.270	8618.270	8618.270	120
Lock inserts		see page	see page	see page	see page	see page	121
180° hinges	4 pc(s).	8618.330	8618.330	8618.330	8618.330	8618.330	111
Punched section with mounting flange, 14 x 39 mm, for tubular door frame	4 pc(s).	8619.700	8619.720	8619.730	8619.710	8619.720	126
Wiring plan pocket, sheet steel, depth 35 mm	1 pc(s).	–	4116.500	4118.500	4115.500	4116.500	127
Wiring plan pocket, sheet steel, depth 90 mm	1 pc(s).	4114.000	4116.000	4118.000	4115.000	4116.000	127
Door stay for escape routes	1 pc(s).	8618.400	8618.400	8618.400	8618.400	8618.400	128
Ride-up roller	10 pc(s).	8618.420	8618.420	8618.420	8618.420	8618.420	128
Mounting plate infill	1 pc(s).	4591.700	4591.700	4591.700	4591.700	4591.700	141
Punched section with mounting flange 18 x 64 mm for the outer level, in the width	4 pc(s).	8617.010	8617.030	8617.040	8617.050	8617.060	150
Punched section with mounting flange 18 x 64 mm for the outer level, in the depth	4 pc(s).	8617.030	8617.030	8617.030	8617.030	8617.030	150
Punched section with mounting flange 23 x 64 mm for the inner level, in the width	4 pc(s).	8617.110	8617.130	8617.140	8617.150	8617.160	150
Punched section with mounting flange 23 x 64 mm for the inner level, in the depth	4 pc(s).	8617.130	8617.130	8617.130	8617.130	8617.130	150
Punched rail 18 x 39 mm for the enclosure depth	4 pc(s).	8617.720	8617.720	8617.720	8617.720	8617.720	151
Support strip for the enclosure depth	20 pc(s).	4696.000	4696.000	4696.000	4696.000	4696.000	152
C rail 30/15, for the enclosure width	6 pc(s).	–	4944.000	4945.000	4946.000	4947.000	152
Support rail 48 x 26 mm, for the enclosure width	2 pc(s).	–	8617.800	8617.810	8617.820	8617.830	152
LED system light		see page	see page	see page	see page	see page	163
Earth straps		see page	see page	see page	see page	see page	169
Cable entry plates		–	8619.800	8619.801	8619.802	8619.803	182
	P. of	–	2 pc(s).	2 pc(s).	4 pc(s).	4 pc(s).	
Cable entry grommets	8 cables, max. Ø 13 mm	25 pc(s).	4316.000	4316.000	4316.000	4316.000	182
	3 cables, max. Ø 21 mm	25 pc(s).	4317.000	4317.000	4317.000	4317.000	182
	1 cable, max. Ø 47 mm	25 pc(s).	4318.000	4318.000	4318.000	4318.000	182
Connector grommets	10 pc(s).	4311.000	4311.000	4311.000	4311.000	4311.000	182
Section for cable entry, centre		–	8618.800	8618.801	8618.802	8618.803	183
	P. of	–	2 pc(s).	2 pc(s).	4 pc(s).	4 pc(s).	
Section for cable entry, rear		–	8618.810	8618.811	8618.812	8618.813	183
	P. of	–	2 pc(s).	2 pc(s).	4 pc(s).	4 pc(s).	
Cable duct		see page	see page	see page	see page	see page	186
Cable clamp rail, right angle section	2 pc(s).	8619.400	8619.410	8619.420	8619.430	8619.440	187

Baying enclosure system VX25

Basic enclosure, height 2000 mm, depth 800 mm

Width (B) mm	P. of	600	800	1200	Page
Height (H) mm		2000	2000	2000	
Depth (T) mm		800	800	800	
Mounting plate width (F) mm		499	699	1099	
Mounting plate height (G) mm		1896	1896	1896	
Model No.	1 pc(s).	8608.000	8808.000	8208.000	
Weight, approx. kg		111.3	137.0	203.0	
Product-specific scope of supply					
Door(s)		1	1	2	
Accessories					
Base/plinth corner pieces with base/plinth trim panel, front and rear, 100 mm	2 pc(s).	8620.002	8620.003	8620.007	85
Base/plinth trim panels, sides, 100 mm	2 pc(s).	8620.034	8620.034	8620.034	86
Base/plinth corner pieces with base/plinth trim panel, front and rear, 200 mm	2 pc(s).	8620.022	8620.023	8620.025	85
Base/plinth trim panels, sides, 200 mm	2 pc(s).	8620.044	8620.044	8620.044	86
Levelling feet	4 pc(s).	4612.000	4612.000	4612.000	91
Side panels, screw-fastened, sheet steel	2 pc(s).	8108.245	8108.245	8108.245	96
Divider panel	1 pc(s).	8609.206	8609.206	8609.206	98
Divider panel for module plates	1 pc(s).	-	-	-	
Baying bracket, internal	6 pc(s).	8617.500	8617.500	8617.500	106
Baying block, internal	6 pc(s).	8617.501	8617.501	8617.501	106
Baying connector, external	6 pc(s).	8617.502	8617.502	8617.502	106
Glazed door	1 pc(s).	8618.020	8618.030	-	110
Comfort handle VX for lock inserts	1 pc(s).	8618.200	8618.200	8618.200	120
Comfort handle VX for lock inserts and padlock	1 pc(s).	8618.230	8618.230	8618.230	120
Comfort handle VX for semi-cylinder	1 pc(s).	8618.250	8618.250	8618.250	120
Comfort handle with security lock insert, lock E1	1 pc(s).	8618.240	8618.240	8618.240	120
Comfort handle VX for ASSA lock system	1 pc(s).	8618.270	8618.270	8618.270	120
Lock inserts		see page	see page	see page	121
180° hinges	4 pc(s).	8618.330	8618.330	8618.330	111
Punched section with mounting flange, 14 x 39 mm, for tubular door frame	4 pc(s).	8619.720	8619.730	8619.720	126
Wiring plan pocket, sheet steel, depth 35 mm	1 pc(s).	4116.500	4118.500	4116.500	127
Wiring plan pocket, sheet steel, depth 90 mm	1 pc(s).	4116.000	4118.000	4116.000	127
Door stay for escape routes	1 pc(s).	8618.400	8618.400	8618.400	128
Ride-up roller	10 pc(s).	8618.420	8618.420	8618.420	128
Mounting plate infill	1 pc(s).	4591.700	4591.700	4591.700	141
Punched section with mounting flange 18 x 64 mm for the outer level, in the width	4 pc(s).	8617.030	8617.040	8617.060	150
Punched section with mounting flange 18 x 64 mm for the outer level, in the depth	4 pc(s).	8617.040	8617.040	8617.040	150
Punched section with mounting flange 23 x 64 mm for the inner level, in the width	4 pc(s).	8617.130	8617.140	8617.160	150
Punched section with mounting flange 23 x 64 mm for the inner level, in the depth	4 pc(s).	8617.140	8617.140	8617.140	150
Punched rail 18 x 39 mm for the enclosure depth	4 pc(s).	8617.730	8617.730	8617.730	151
Support strip for the enclosure depth	20 pc(s).	4697.000	4697.000	4697.000	152
C rail 30/15, for the enclosure width	6 pc(s).	4944.000	4945.000	4947.000	152
Support rail 48 x 26 mm, for the enclosure width	2 pc(s).	8617.800	8617.810	8617.830	152
LED system light		see page	see page	see page	163
Earth straps		see page	see page	see page	169
Cable entry plates		8619.800	8619.801	8619.803	182
	P. of	2 pc(s).	2 pc(s).	4 pc(s).	
Cable entry grommets	8 cables, max. Ø 13 mm	25 pc(s).	4316.000	4316.000	182
	3 cables, max. Ø 21 mm	25 pc(s).	4317.000	4317.000	182
	1 cable, max. Ø 47 mm	25 pc(s).	4318.000	4318.000	182
Connector grommets	10 pc(s).	4311.000	4311.000	4311.000	182
Section for cable entry, centre		8618.800	8618.801	8618.803	183
	P. of	2 pc(s).	2 pc(s).	4 pc(s).	
Section for cable entry, rear		8618.810	8618.811	8618.813	183
	P. of	2 pc(s).	2 pc(s).	4 pc(s).	
Cable duct		see page	see page	see page	186
Cable clamp rail, right angle section	2 pc(s).	8619.410	8619.420	8619.440	187

Baying enclosure system VX25

Basic enclosure, height 2200 mm, depth 600 mm

Width (B) mm	P. of	600	800	1200	Page
Height (H) mm		2200	2200	2200	
Depth (T) mm		600	600	600	
Mounting plate width (F) mm		499	699	1099	
Mounting plate height (G) mm		2096	2096	2096	
Model No.	1 pc(s).	8626.000	8826.000	8226.000	
Weight, approx. kg		113.1	139.3	208.0	
Product-specific scope of supply					
Door(s)		1	1	2	
Accessories					
Base/plinth corner pieces with base/plinth trim panel, front and rear, 100 mm	2 pc(s).	8620.002	8620.003	8620.007	85
Base/plinth trim panels, sides, 100 mm	2 pc(s).	8620.033	8620.033	8620.033	86
Base/plinth corner pieces with base/plinth trim panel, front and rear, 200 mm	2 pc(s).	8620.022	8620.023	8620.025	85
Base/plinth trim panels, sides, 200 mm	2 pc(s).	8620.043	8620.043	8620.043	86
Levelling feet	4 pc(s).	4612.000	4612.000	4612.000	91
Side panels, screw-fastened, sheet steel	2 pc(s).	8126.245	8126.245	8126.245	96
Divider panel	1 pc(s).	8609.207	8609.207	8609.207	98
Divider panel for module plates	1 pc(s).	–	–	–	
Baying bracket, internal	6 pc(s).	8617.500	8617.500	8617.500	106
Baying block, internal	6 pc(s).	8617.501	8617.501	8617.501	106
Baying connector, external	6 pc(s).	8617.502	8617.502	8617.502	106
Glazed door	1 pc(s).	8618.040	8618.050	–	110
Comfort handle VX for lock inserts	1 pc(s).	8618.200	8618.200	8618.200	120
Comfort handle VX for lock inserts and padlock	1 pc(s).	8618.230	8618.230	8618.230	120
Comfort handle VX for semi-cylinder	1 pc(s).	8618.250	8618.250	8618.250	120
Comfort handle with security lock insert, lock E1	1 pc(s).	8618.240	8618.240	8618.240	120
Comfort handle VX for ASSA lock system	1 pc(s).	8618.270	8618.270	8618.270	120
Lock inserts		see page	see page	see page	121
180° hinges	4 pc(s).	8618.330	8618.330	8618.330	111
Punched section with mounting flange, 14 x 39 mm, for tubular door frame	4 pc(s).	8619.720	8619.730	8619.720	126
Wiring plan pocket, sheet steel, depth 35 mm	1 pc(s).	4116.500	4118.500	4116.500	127
Wiring plan pocket, sheet steel, depth 90 mm	1 pc(s).	4116.000	4118.000	4116.000	127
Door stay for escape routes	1 pc(s).	8618.400	8618.400	8618.400	128
Ride-up roller	10 pc(s).	8618.420	8618.420	8618.420	128
Mounting plate infill	1 pc(s).	4592.700	4592.700	4592.700	141
Punched section with mounting flange 18 x 64 mm for the outer level, in the width	4 pc(s).	8617.030	8617.040	8617.060	150
Punched section with mounting flange 18 x 64 mm for the outer level, in the depth	4 pc(s).	8617.030	8617.030	8617.030	150
Punched section with mounting flange 23 x 64 mm for the inner level, in the width	4 pc(s).	8617.130	8617.140	8617.160	150
Punched section with mounting flange 23 x 64 mm for the inner level, in the depth	4 pc(s).	8617.130	8617.130	8617.130	150
Punched rail 18 x 39 mm for the enclosure depth	4 pc(s).	8617.720	8617.720	8617.720	151
Support strip for the enclosure depth	20 pc(s).	4696.000	4696.000	4696.000	152
C rail 30/15, for the enclosure width	6 pc(s).	4944.000	4945.000	4947.000	152
Support rail 48 x 26 mm, for the enclosure width	2 pc(s).	8617.800	8617.810	8617.830	152
LED system light		see page	see page	see page	163
Earth straps		see page	see page	see page	169
Cable entry plates		8619.800	8619.801	8619.803	182
	P. of	2 pc(s).	2 pc(s).	4 pc(s).	
Cable entry grommets	8 cables, max. Ø 13 mm	25 pc(s).	4316.000	4316.000	182
	3 cables, max. Ø 21 mm	25 pc(s).	4317.000	4317.000	182
	1 cables, max. Ø 47 mm	25 pc(s).	4318.000	4318.000	182
Connector grommets	10 pc(s).	4311.000	4311.000	4311.000	182
Section for cable entry, centre		8618.800	8618.801	8618.803	183
	P. of	2 pc(s).	2 pc(s).	4 pc(s).	
Section for cable entry, rear		8618.810	8618.811	8618.813	183
	P. of	2 pc(s).	2 pc(s).	4 pc(s).	
Cable duct		see page	see page	see page	186
Cable clamp rail, right angle section	2 pc(s).	8619.410	8619.420	8619.440	187

Baying enclosure system VX25



System accessories Page 78 482.6 mm (19") installation accessories Page 192

Material and surface finish:

- Enclosure frame: Sheet steel, 1.5 mm, dipcoat-primed
- Roof: Sheet steel, 1.5 mm, dipcoat-primed, powder-coated on the outside, textured paint
- Front frame: Extruded aluminium section, powder-coated
- Rear door: Sheet steel, 2 mm, dipcoat-primed, powder-coated on the outside, textured paint

- Gland plates: Sheet steel, 1.5 mm, zinc-plated
- Adaptor sections, 482.6 mm (19"): Sheet steel, zinc-plated

Colour:

- RAL 7035

Supply includes:

- Enclosure frame
- Front frame (r/h hinge, held on the left via mechanical snap fasteners)
- Rear door (r/h hinge, may be swapped to opposite side)
- Roof plate
- Gland plates
- Adaptor sections, 482.6 mm (19"), front

Approvals:

- UL
- cUL

Electronic enclosure

Height units U	P. of	33	33	42	42	Page
Width mm		600	600	600	600	
Height mm		1600	1600	2000	2000	
Depth mm		600	800	600	800	
Model No.	1 pc(s).	8410.000	8418.000	8430.000	8438.000	
Weight, approx. kg		61.5	67.5	69.4	75.4	

Accessories

Base/plinth corner pieces with base/plinth trim panel, front and rear, 100 mm	2 pc(s).	8620.002	8620.002	8620.002	8620.002	85
Base/plinth trim panels, sides, 100 mm	2 pc(s).	8620.033	8620.034	8620.033	8620.034	86
Base/plinth corner pieces with base/plinth trim panel, front and rear, 200 mm	2 pc(s).	8620.022	8620.022	8620.022	8620.022	85
Base/plinth trim panels, sides, 200 mm	2 pc(s).	8620.043	8620.044	8620.043	8620.044	86
Levelling feet	4 pc(s).	4612.000	4612.000	4612.000	4612.000	91
Side panels, screw-fastened, sheet steel	2 pc(s).	8166.245	8168.245	8106.245	8108.245	96
Comfort handle VX for lock inserts	1 pc(s).	8618.200	8618.200	8618.200	8618.200	120
Comfort handle VX for lock inserts and padlock	1 pc(s).	8618.230	8618.230	8618.230	8618.230	120
Comfort handle VX for semi-cylinder	1 pc(s).	8618.250	8618.250	8618.250	8618.250	120
Lock inserts		see page	see page	see page	see page	121
Punched section with mounting flange 18 x 64 mm for the outer level, in the depth	4 pc(s).	8617.030	8617.040	8617.030	8617.040	150
LED system light		see page	see page	see page	see page	163
Section for cable entry, centre	2 pc(s).	8618.800	8618.800	8618.800	8618.800	183
Section for cable entry, rear	2 pc(s).	8618.810	8618.810	8618.810	8618.810	183
Cable clamp rail, right angle section	2 pc(s).	8619.410	8619.410	8619.410	8619.410	187
Adaptor section, 482.6 mm (19")	2 pc(s).	8619.300	8619.300	8619.320	8619.320	195
Adaptor piece, 482.6 mm (19")	4 pc(s).	8619.330	8619.330	8619.330	8619.330	195
Slide rail with two-sided mounting	10 pc(s).	8613.160	8613.180	8613.160	8613.180	196
Slide rail with one-sided mounting	10 pc(s).	4531.000	4531.000	4531.000	4531.000	196
482.6 mm (19") fastener, 1 U	24 pc(s).	2090.000	2090.000	2090.000	2090.000	196

Baying enclosure system VX25



System accessories Page 78

Material and surface finish:

- Enclosure frame: Sheet steel, 1.5 mm, dipcoat-primed and powder-coated, textured paint
- Roof: Sheet steel, 1.5 mm, dipcoat-primed and powder-coated, textured paint
- Door: Sheet steel, 2 mm, dipcoat-primed and powder-coated, textured paint
- Rear panel: Sheet steel, 1.5 mm, dipcoat-primed and powder-coated, textured paint
- Gland plate: Sheet steel, 1.5 mm, dipcoat-primed and powder-coated, textured paint
- Mounting plate: Sheet steel, 3 mm, zinc-plated

Colour:

- RAL 7035

Protection category IP to IEC 60 529:

- IP 66

NEMA protection category:

- NEMA 4

Supply includes:

- Enclosure frame
- Door (r/h hinge, may be swapped to opposite side)
- Roof plate
- Base
- Rear panel
- Mounting plate
- Lock: 3 mm double-bit
- 2 punched rails 18 x 39 mm

Approvals:

- UL
- cUL

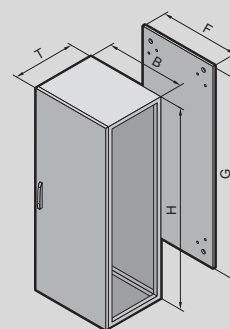

IP 66/NEMA 4

Width (B) mm	P. of	800	Page
Height (H) mm		2000	
Depth (T) mm		600	
Mounting plate width (F) mm		699	
Mounting plate height (G) mm		1896	
Model No.	1 pc(s).	8807.000	
Accessories			
Base/plinth corner pieces with base/plinth trim panel, front and rear, 100 mm	2 pc(s).	8620.003	85
Base/plinth trim panels, sides, 100 mm	2 pc(s).	8620.033	86
Base/plinth corner pieces with base/plinth trim panel, front and rear, 200 mm	2 pc(s).	8620.023	85
Base/plinth trim panels, sides, 200 mm	2 pc(s).	8620.043	86
Levelling feet	4 pc(s).	4612.000	91
Side panels, screw-fastened, sheet steel	2 pc(s).	8106.245	96
Baying bracket, internal	6 pc(s).	8617.500	106
Baying block, internal	6 pc(s).	8617.501	106
Baying connector, external	6 pc(s).	8617.502	106
Comfort handle VX for lock inserts	1 pc(s).	8618.200	120
Comfort handle VX for semi-cylinder	1 pc(s).	8618.250	120
Wiring plan pocket, sheet steel, depth 35 mm	1 pc(s).	4118.500	127
Wiring plan pocket, sheet steel, depth 90 mm	1 pc(s).	4118.000	127
LED system light		see page	163
Cable duct		see page	186
Cable clamp rail, right angle section	2 pc(s).	8619.420	187

Baying enclosure system VX25



System accessories Page 78 ISV installation modules Page 172

Material and surface finish:

- Enclosure frame: Sheet steel, 1.5 mm, dipcoat-primed
- Roof: Sheet steel, 1.5 mm, dipcoat-primed, powder-coated on the outside, textured paint
- Door: Sheet steel, 2 mm, dipcoat-primed, powder-coated on the outside, textured paint
- Rear panel: Sheet steel, 1.5 mm, dipcoat-primed, powder-coated on the outside, textured paint
- Gland plates: Sheet steel, 1.5 mm, zinc-plated

Colour:

- RAL 7035

Basis of test:

- IEC 61 439-1/-2

Protection category IP to IEC 60 529:

- IP 55

NEMA protection category:

- NEMA 12

Supply includes:

- Enclosure frame
- Door(s) (r/h hinge, may be swapped to opposite side)
- Gland plates
- Roof plate
- Rear panel
- Lock: 3 mm double-bit

Note:

- For 600 mm wide distribution enclosures, please use basic enclosures, see page 54 onwards

Distribution enclosure

Width mm	P. of	850	1100	850	1100	Page
Height mm		2000	2000	2000	2000	
Depth mm		400	400	600	600	
Model No.	1 pc(s).	9666.956	9666.966	9666.916	9666.926	
Weight, approx. kg		111.0	146.0	117.0	156.0	
Door(s)		1	2	1	2	
Also required						
Installation kit	1 pc(s).	9666.912	9666.922	9666.912	9666.922	171
Mounting angle	2 pc(s).	9666.712	9666.712	9666.712	9666.712	178
Depth stay	2 pc(s).	-	9666.732	-	9666.732	178
Accessories						
Base/plinth corner pieces with base/plinth trim panel, front and rear, 100 mm	2 pc(s).	8620.004	8620.006	8620.004	8620.006	85
Base/plinth trim panels, sides, 100 mm	2 pc(s).	8620.031	8620.031	8620.033	8620.033	86
Base/plinth corner pieces with base/plinth trim panel, front and rear, 200 mm	2 pc(s).	2 x 8620.004	2 x 8620.006	2 x 8620.004	2 x 8620.006	85
Base/plinth trim panels, sides, 200 mm	2 pc(s).	8620.031	8620.031	8620.033	8620.033	86
Levelling feet	4 pc(s).	4612.000	4612.000	4612.000	4612.000	91
Side panels, screw-fastened, sheet steel	2 pc(s).	8104.245	8104.245	8106.245	8106.245	96
Baying bracket, internal	6 pc(s).	8617.500	8617.500	8617.500	8617.500	106
Baying block, internal	6 pc(s).	8617.501	8617.501	8617.501	8617.501	106
Baying connector, external	6 pc(s).	8617.502	8617.502	8617.502	8617.502	106
Roof plate for cable entry glands	1 pc(s).	9681.594	9681.514	9681.596	9681.516	136
Cable entry glands	14 x M25/32	1 pc(s).	9665.750	9665.750	9665.750	137
	2 x M25/32/40, 1 x M32/40/50, 2 x M40/50/63	1 pc(s).	9665.760	9665.760	9665.760	137
	With sealing membranes 32 x Ø 7 – 16 mm, 4 x Ø 10 – 20 mm, 3 x Ø 14 – 26 mm	1 pc(s).	9665.770	9665.770	9665.770	137
	With entry fittings up to Ø 66 mm	1 pc(s).	9665.780	9665.780	9665.780	137
	Solid	4 pc(s).	9665.785	9665.785	9665.785	137

Baying enclosure system VX25



System accessories Page 78 **Installation accessories for modular front design** Page 114

Material and surface finish:

- Enclosure frame: Sheet steel, 1.5 mm, dipcoat-primed
- Rear panel: Sheet steel, 1.5 mm, dipcoat-primed, powder-coated on the outside, textured paint
- Gland plates: Sheet steel, 1.5 mm, zinc-plated

Colour:

- RAL 7035

Basis of test:

- IEC 61 439-1/-2
- IEC 61 641

Protection category IP to IEC 60 529:

- Up to IP 54, depending on the panels

Supply includes:

- Enclosure frame
- Rear panel
- Gland plates

Modular enclosure, height 2000 mm

Width mm	P. of	400	600	800	400	600	800	Page
Height mm		2000	2000	2000	2000	2000	2000	
Depth mm		600	600	600	800	800	800	
Model No.	1 pc(s).	9680.406	9680.606	9680.806	9680.408	9680.608	9680.808	
Weight, approx. kg		43.8	51.0	61.0	46.0	53.7	64.2	
Accessories								
Base/plinth corner pieces with base/plinth trim panel, front and rear, 100 mm	2 pc(s).	8620.001	8620.002	8620.003	8620.001	8620.002	8620.003	85
Base/plinth trim panels, sides, 100 mm	2 pc(s).	8620.033	8620.033	8620.033	8620.034	8620.034	8620.034	86
Base/plinth corner pieces with base/plinth trim panel, front and rear, 200 mm	2 pc(s).	8620.021	8620.022	8620.023	8620.021	8620.022	8620.023	85
Base/plinth trim panels, sides, 200 mm	2 pc(s).	8620.043	8620.043	8620.043	8620.044	8620.044	8620.044	86
Levelling feet	4 pc(s).	4612.000	4612.000	4612.000	4612.000	4612.000	4612.000	91
Side panels, screw-fastened, sheet steel	2 pc(s).	8106.245	8106.245	8106.245	8108.245	8108.245	8108.245	96
Baying bracket, internal	6 pc(s).	8617.500	8617.500	8617.500	8617.500	8617.500	8617.500	106
Baying block, internal	6 pc(s).	8617.501	8617.501	8617.501	8617.501	8617.501	8617.501	106
Baying connector, external	6 pc(s).	8617.502	8617.502	8617.502	8617.502	8617.502	8617.502	106
Glazed door	1 pc(s).	-	8618.020	8618.030	-	8618.020	8618.030	110
Partial doors		see page	see page	see page	see page	see page	see page	115
Front trim panels, top		see page	see page	see page	see page	see page	see page	116
Front trim panels, bottom, solid		see page	see page	see page	see page	see page	see page	116
Front trim panels, bottom, vented	1 pc(s).	9682.354	9682.356	9682.358	9682.354	9682.356	9682.358	116
Roof plate IP 55, solid	1 pc(s).	9681.646	9681.666	9681.686	9681.648	9681.668	9681.688	136
Roof plate IP 2X with ventilation hole	1 pc(s).	9681.846	9681.866	9681.886	9681.848	9681.868	9681.888	136
Roof plate for cable entry glands	1 pc(s).	9681.546	9681.566	9681.586	9681.548	9681.568	9681.588	136

Baying enclosure system VX25

Modular enclosure, height 2200 mm

Width mm	P. of	400	600	800	400	600	800	Page
Height mm		2200	2200	2200	2200	2200	2200	
Depth mm		600	600	600	800	800	800	
Model No.	1 pc(s).	9680.426	9680.626	9680.826	9680.428	9680.628	9680.828	
Weight, approx. kg		43.2	54.0	59.4	46.1	55.8	66.0	

Accessories								
Base/plinth corner pieces with base/plinth trim panel, front and rear, 100 mm	2 pc(s).	8620.001	8620.002	8620.003	8620.001	8620.002	8620.003	85
Base/plinth trim panels, sides, 100 mm	2 pc(s).	8620.033	8620.033	8620.033	8620.034	8620.034	8620.034	86
Base/plinth corner pieces with base/plinth trim panel, front and rear, 200 mm	2 pc(s).	8620.021	8620.022	8620.023	8620.021	8620.022	8620.023	85
Base/plinth trim panels, sides, 200 mm	2 pc(s).	8620.043	8620.043	8620.043	8620.044	8620.044	8620.044	86
Levelling feet	4 pc(s).	4612.000	4612.000	4612.000	4612.000	4612.000	4612.000	91
Side panels, screw-fastened, sheet steel	2 pc(s).	8126.245	8126.245	8126.245	8128.245	8128.245	8128.245	96
Baying bracket, internal	6 pc(s).	8617.500	8617.500	8617.500	8617.500	8617.500	8617.500	106
Baying block, internal	6 pc(s).	8617.501	8617.501	8617.501	8617.501	8617.501	8617.501	106
Baying connector, external	6 pc(s).	8617.502	8617.502	8617.502	8617.502	8617.502	8617.502	106
Glazed door	1 pc(s).	–	8618.040	8618.050	–	8618.040	8618.050	110
Partial doors		see page	see page	see page	see page	see page	see page	115
Front trim panels, top		see page	see page	see page	see page	see page	see page	116
Front trim panels, bottom, solid		see page	see page	see page	see page	see page	see page	116
Front trim panels, bottom, vented	1 pc(s).	9682.354	9682.356	9682.358	9682.354	9682.356	9682.358	116
Roof plate IP 55, solid	1 pc(s).	9681.646	9681.666	9681.686	9681.648	9681.668	9681.688	136
Roof plate IP 2X with ventilation hole	1 pc(s).	9681.846	9681.866	9681.886	9681.848	9681.868	9681.888	136
Roof plate for cable entry glands	1 pc(s).	9681.546	9681.566	9681.586	9681.548	9681.568	9681.588	136

Baying enclosure system VX25, stainless steel



Lock systems Page 120 VX25, sheet steel Page 54

Material and surface finish:

- Enclosure frame: Stainless steel 1.4301 (AISI 304), 1.5 mm
- Roof: Stainless steel 1.4301 (AISI 304), 1.5 mm, exterior brushed, grain size 400
- Door: Stainless steel 1.4301 (AISI 304), 2 mm, exterior brushed, grain size 400
- Rear panel: Stainless steel 1.4301 (AISI 304), 1.5 mm, exterior brushed, grain size 400
- Gland plates: Stainless steel 1.4301 (AISI 304), 1.5 mm
- Mounting plate: Sheet steel, 3 mm, zinc-plated

Protection category IP to IEC 60 529:

- IP 55

NEMA protection category:

- NEMA 12

Supply includes:

- Enclosure frame
- Door(s) (r/h hinge, may be swapped to opposite side)
- Roof plate
- Gland plates
- Rear panel
- Mounting plate
- Lock: 3 mm double-bit
- 2 punched rails 18 x 39 mm

Note:

- Due to the hardness of the material, we recommend using metal multi-tooth screw 2486.400 for the interior installation.

Approvals:

- UL
- cUL
- Further approvals can be found on the Internet

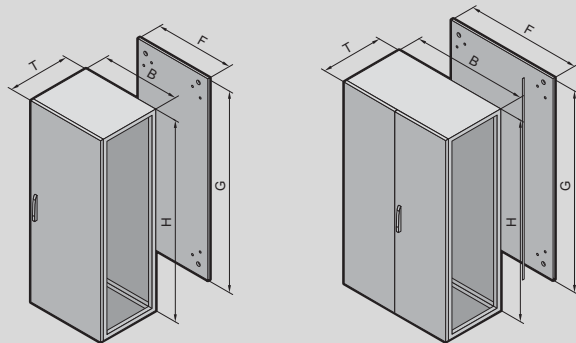

Baying enclosure system VX25, stainless steel

Basic enclosure, height 1800 mm, depth 400 mm

Width (B) mm	P. of	800	1200	Page
Height (H) mm		1800	1800	
Depth (T) mm		400	400	
Mounting plate width (F) mm		699	1099	
Mounting plate height (G) mm		1696	1696	
Model No.	1 pc(s).	8454.000	8456.000	
Weight, approx. kg		112.9	170.4	
Product-specific scope of supply				
Door(s)		1	2	
Accessories				
Base/plinth corner pieces with base/plinth trim panel, front and rear, 100 mm	2 pc(s).	8620.051	8620.053	87
Base/plinth trim panels, sides, 100 mm	2 pc(s).	8620.070	8620.070	88
Base/plinth corner pieces with base/plinth trim panel, front and rear, 200 mm	2 pc(s).	8620.061	8620.063	87
Base/plinth trim panels, sides, 200 mm	2 pc(s).	8620.080	8620.080	88
Levelling feet	4 pc(s).	8100.780	8100.780	91
Punched section with mounting flange 23 x 89 mm, stainless steel, in the depth	4 pc(s).	8100.730	8100.730	151
Side panels, screw-fastened, stainless steel	2 pc(s).	8700.030	8700.030	96
Divider panel	1 pc(s).	8609.200	8609.200	98
Divider panel for module plates	1 pc(s).	-	-	
Baying bracket, internal	6 pc(s).	8617.500	8617.500	106
Baying block, internal	6 pc(s).	8617.501	8617.501	106
Baying connector, external, stainless steel	6 pc(s).	8617.503	8617.503	106
Comfort handle VX for lock inserts	1 pc(s).	8618.220	8618.220	120
Comfort handle VX for semi-cylinder	1 pc(s).	8618.280	8618.280	120
Lock inserts		see page	see page	121
180° hinges, stainless steel	4 pc(s).	8618.340	8618.340	111
Punched section with mounting flange, 14 x 39 mm, for tubular door frame	4 pc(s).	8619.730	8619.720	126
Wiring plan pocket, sheet steel, depth 35 mm	1 pc(s).	4118.500	4116.500	127
Wiring plan pocket, sheet steel, depth 90 mm	1 pc(s).	4118.000	4116.000	127
Door stay for escape routes	1 pc(s).	8618.400	8618.400	128
Ride-up roller	10 pc(s).	8618.420	8618.420	128
Mounting plate infill	1 pc(s).	4590.700	4590.700	141
Punched section with mounting flange 18 x 64 mm for the outer level, in the width	4 pc(s).	8617.040	8617.060	150
Punched section with mounting flange 18 x 64 mm for the outer level, in the depth	4 pc(s).	8617.010	8617.010	150
Punched section with mounting flange 23 x 64 mm for the inner level, in the width	4 pc(s).	8617.140	8617.160	150
Punched section with mounting flange 23 x 64 mm for the inner level, in the depth	4 pc(s).	8617.110	8617.110	150
Punched rail 18 x 39 mm for enclosure depth	4 pc(s).	8617.700	8617.700	151
Support strip for the enclosure depth	20 pc(s).	4694.000	4694.000	152
C rail 30/15, for the enclosure width	6 pc(s).	4945.000	4947.000	152
Support rail 48 x 26 mm, for the enclosure width	2 pc(s).	8617.810	8617.830	152
LED system light		see page	see page	163
Earth straps		see page	see page	169
Section for cable entry, centre		8618.801	8618.803	183
	P. of	2 pc(s).	4 pc(s).	
Section for cable entry, rear		8618.811	8618.813	183
	P. of	2 pc(s).	4 pc(s).	
Cable duct		see page	see page	186
Metal multi-tooth screws	300 pc(s).	2486.400	2486.400	158
Cable clamp rail, right angle section	2 pc(s).	8619.420	8619.440	187

Baying enclosure system VX25, stainless steel

Basic enclosure, height 1800 mm, depth 500 mm

Width (B) mm	P. of	600	800	1200	Page
Height (H) mm		1800	1800	1800	
Depth (T) mm		500	500	500	
Mounting plate width (F) mm		499	699	1099	
Mounting plate height (G) mm		1696	1696	1696	
Model No.	1 pc(s).	8457.000	8455.000	8453.000	
Weight, approx. kg		92.5	116.3	174.9	
Product-specific scope of supply					
Door(s)		1	1	2	
Accessories					
Base/plinth corner pieces with base/plinth trim panel, front and rear, 100 mm	2 pc(s).	8620.050	8620.051	8620.053	87
Base/plinth trim panels, sides, 100 mm	2 pc(s).	8620.071	8620.071	8620.071	88
Base/plinth corner pieces with base/plinth trim panel, front and rear, 200 mm	2 pc(s).	8620.060	8620.061	8620.063	87
Base/plinth trim panels, sides, 200 mm	2 pc(s).	8620.081	8620.081	8620.081	88
Levelling feet	4 pc(s).	8100.780	8100.780	8100.780	91
Punched section with mounting flange 23 x 89 mm, stainless steel, in the depth	4 pc(s).	8100.731	8100.731	8100.731	151
Side panels, screw-fastened, stainless steel	2 pc(s).	8700.040	8700.040	8700.040	96
Divider panel	1 pc(s).	8609.201	8609.201	8609.201	98
Divider panel for module plates	1 pc(s).	8609.210	8609.210	8609.210	99
Baying bracket, internal	6 pc(s).	8617.500	8617.500	8617.500	106
Baying block, internal	6 pc(s).	8617.501	8617.501	8617.501	106
Baying connector, external, stainless steel	6 pc(s).	8617.503	8617.503	8617.503	106
Comfort handle VX for lock inserts	1 pc(s).	8618.220	8618.220	8618.220	120
Comfort handle VX for semi-cylinder	1 pc(s).	8618.280	8618.280	8618.280	120
Lock inserts		see page	see page	see page	121
180° hinges, stainless steel	4 pc(s).	8618.340	8618.340	8618.340	111
Punched section with mounting flange, 14 x 39 mm, for tubular door frame	4 pc(s).	8619.720	8619.730	8619.720	126
Wiring plan pocket, sheet steel, depth 35 mm	1 pc(s).	4116.500	4118.500	4116.500	127
Wiring plan pocket, sheet steel, depth 90 mm	1 pc(s).	4116.000	4118.000	4116.000	127
Door stay for escape routes	1 pc(s).	8618.400	8618.400	8618.400	128
Ride-up roller	10 pc(s).	8618.420	8618.420	8618.420	128
Mounting plate infill	1 pc(s).	4590.700	4590.700	4590.700	141
Punched section with mounting flange 18 x 64 mm for the outer level, in the width	4 pc(s).	8617.030	8617.040	8617.060	150
Punched section with mounting flange 18 x 64 mm for the outer level, in the depth	4 pc(s).	8617.020	8617.020	8617.020	150
Punched section with mounting flange 23 x 64 mm for the inner level, in the width	4 pc(s).	8617.130	8617.140	8617.160	150
Punched section with mounting flange 23 x 64 mm for the inner level, in the depth	4 pc(s).	8617.120	8617.120	8617.120	150
Punched rail 18 x 39 mm for the enclosure depth	4 pc(s).	8617.710	8617.710	8617.710	151
Support strip for the enclosure depth	20 pc(s).	4695.000	4695.000	4695.000	152
C rail 30/15, for the enclosure width	6 pc(s).	4944.000	4945.000	4947.000	152
Support rail 48 x 26 mm, for the enclosure width	2 pc(s).	8617.800	8617.810	8617.830	152
LED system light		see page	see page	see page	163
Earth straps		see page	see page	see page	169
Section for cable entry, centre		8618.800	8618.801	8618.803	183
	P. of	2 pc(s).	2 pc(s).	4 pc(s).	
Section for cable entry, rear		8618.810	8618.811	8618.813	183
	P. of	2 pc(s).	2 pc(s).	4 pc(s).	
Cable duct		see page	see page	see page	186
Metal multi-tooth screws	300 pc(s).	2486.400	2486.400	2486.400	158
Cable clamp rail, right angle section	2 pc(s).	8619.410	8619.420	8619.440	187

Baying enclosure system VX25, stainless steel

Basic enclosure, height 2000 mm, depth 600 mm

Width (B) mm	P. of	600	800	1200	Page
Height (H) mm		2000	2000	2000	
Depth (T) mm		600	600	600	
Mounting plate width (F) mm		499	699	1099	
Mounting plate height (G) mm		1896	1896	1896	
Model No.	1 pc(s).	8452.000	8450.000	8451.000	
Weight, approx. kg		104.4	129.7	194.7	
Product-specific scope of supply					
Door(s)		1	1	2	
Accessories					
Base/plinth corner pieces with base/plinth trim panel, front and rear, 100 mm	2 pc(s).	8620.050	8620.051	8620.053	87
Base/plinth trim panels, sides, 100 mm	2 pc(s).	8620.072	8620.072	8620.072	88
Base/plinth corner pieces with base/plinth trim panel, front and rear, 200 mm	2 pc(s).	8620.060	8620.061	8620.063	87
Base/plinth trim panels, sides, 200 mm	2 pc(s).	8620.082	8620.082	8620.082	88
Levelling feet	4 pc(s).	8100.780	8100.780	8100.780	91
Punched section with mounting flange 23 x 89 mm, stainless steel, in the depth	4 pc(s).	8100.732	8100.732	8100.732	151
Side panels, screw-fastened, stainless steel	2 pc(s).	8700.050	8700.050	8700.050	96
Divider panel	1 pc(s).	8609.205	8609.205	8609.205	98
Divider panel for module plates	1 pc(s).	8609.213	8609.213	8609.213	99
Baying bracket, internal	6 pc(s).	8617.500	8617.500	8617.500	106
Baying block, internal	6 pc(s).	8617.501	8617.501	8617.501	106
Baying connector, external, stainless steel	6 pc(s).	8617.503	8617.503	8617.503	106
Comfort handle VX for lock inserts	1 pc(s).	8618.220	8618.220	8618.220	120
Comfort handle VX for semi-cylinder	1 pc(s).	8618.280	8618.280	8618.280	120
Lock inserts		see page	see page	see page	121
180° hinges, stainless steel	4 pc(s).	8618.340	8618.340	8618.340	111
Punched section with mounting flange, 14 x 39 mm, for tubular door frame	4 pc(s).	8619.720	8619.730	8619.720	126
Wiring plan pocket, sheet steel, depth 35 mm	1 pc(s).	4116.500	4118.500	4116.500	127
Wiring plan pocket, sheet steel, depth 90 mm	1 pc(s).	4116.000	4118.000	4116.000	127
Door stay for escape routes	1 pc(s).	8618.400	8618.400	8618.400	128
Ride-up roller	10 pc(s).	8618.420	8618.420	8618.420	128
Mounting plate infill	1 pc(s).	4591.700	4591.700	4591.700	141
Punched section with mounting flange 18 x 64 mm for the outer level, in the width	4 pc(s).	8617.030	8617.040	8617.060	150
Punched section with mounting flange 18 x 64 mm for the outer level, in the depth	4 pc(s).	8617.030	8617.030	8617.030	150
Punched section with mounting flange 23 x 64 mm for the inner level, in the width	4 pc(s).	8617.130	8617.140	8617.160	150
Punched section with mounting flange 23 x 64 mm for the inner level, in the depth	4 pc(s).	8617.130	8617.130	8617.130	150
Punched rail 18 x 39 mm for the enclosure depth	4 pc(s).	8617.720	8617.720	8617.720	151
Support strip for the enclosure depth	20 pc(s).	4696.000	4696.000	4696.000	152
C rail 30/15, for the enclosure width	6 pc(s).	4944.000	4945.000	4947.000	152
Support rail 48 x 26 mm, for the enclosure width	2 pc(s).	8617.800	8617.810	8617.830	152
LED system light		see page	see page	see page	163
Earth straps		see page	see page	see page	169
Section for cable entry, centre		8618.800	8618.801	8618.803	183
	P. of	2 pc(s).	2 pc(s).	4 pc(s).	
Section for cable entry, rear		8618.810	8618.811	8618.813	183
	P. of	2 pc(s).	2 pc(s).	4 pc(s).	
Cable duct		see page	see page	see page	186
Metal multi-tooth screws	300 pc(s).	2486.400	2486.400	2486.400	158
Cable clamp rail, right angle section	2 pc(s).	8619.410	8619.420	8619.440	187

Baying enclosure system VX25, stainless steel



System accessories Page 78 Cable entry Page 182

Material and surface finish:

- Enclosure frame: Stainless steel 1.4301 (AISI 304), 1.5 mm
- Roof: Stainless steel 1.4301 (AISI 304), 1.5 mm, exterior brushed, grain size 400
- Door: Stainless steel 1.4301 (AISI 304), 2 mm, exterior brushed, grain size 400
- Rear panel: Stainless steel 1.4301 (AISI 304), 1.5 mm, exterior brushed, grain size 400
- Gland plate: Stainless steel 1.4301 (AISI 304), 1.5 mm
- Mounting plate: Sheet steel, 3 mm, zinc-plated

Supply includes:

- Enclosure frame
- Door(s) (r/h hinge, may be swapped to opposite side)
- Roof
- Gland plate
- Rear panel
- Mounting plate
- Lock: 3 mm double-bit
- 2 punched rails 18 x 39 mm

Note:

- Due to the hardness of the material, we recommend using metal multi-tooth screw 2486.400 for the interior installation.

Approvals:

- UL
- cUL

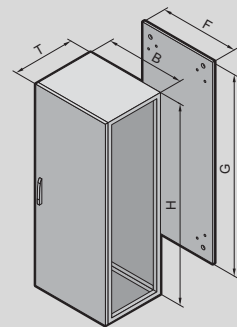

Protection category IP to IEC 60 529:

- IP 66

NEMA protection category:

- NEMA 4X

IP 66/NEMA 4X

Width (B) mm	P. of	800	Page
Height (H) mm		2000	
Depth (T) mm		600	
Mounting plate width (F) mm		699	
Mounting plate height (G) mm		1896	
Model No.	1 pc(s).	8458.000	
Weight, approx. kg		128.9	

Accessories			
Base/plinth corner pieces with base/plinth trim panel, front and rear, 100 mm	2 pc(s).	8620.051	87
Base/plinth trim panels, sides, 100 mm	2 pc(s).	8620.070	88
Base/plinth corner pieces with base/plinth trim panel, front and rear, 200 mm	2 pc(s).	8620.061	87
Base/plinth trim panels, sides, 200 mm	2 pc(s).	8620.080	88
Punched section with mounting flange 23 x 89 mm, stainless steel, in the depth	4 pc(s).	8100.732	151
Side panels, screw-fastened, stainless steel	2 pc(s).	8700.050	96
Baying bracket, internal	6 pc(s).	8617.500	106
Baying block, internal	6 pc(s).	8617.501	106
Comfort handle VX for lock inserts	1 pc(s).	8618.220	120
Comfort handle VX for semi-cylinder	1 pc(s).	8618.280	120
Lock inserts		see page	121
Wiring plan pocket, sheet steel, depth 35 mm	1 pc(s).	4118.500	127
Wiring plan pocket, sheet steel, depth 90 mm	1 pc(s).	4118.000	127
LED system light		see page	163
Cable duct		see page	186
Cable clamp rail, right angle section	2 pc(s).	8619.420	187



Ease of use

Intuitive operation via touch display



Time savings

The cooling unit can be easily pulled out from the front for maintenance purposes

VX25 and Blue e+

- Cooling unit with 1.5 kW and Blue e+ technology in the dimensions W x H x D 800 x 2200 x 600 mm – integrated into the VX25 baying enclosure system
- No assembly outlay – the cooling unit, door limit switch and connection cabling are installed ready-to-connect
- State-of-the-art design – not a cooling unit built onto the enclosure

Excellent planning certainty

- The digital twin of the Blue e+ integration solution is available in the EPLAN Data Portal
- Dependable and efficient construction planning with EPLAN Pro Panel
- “Thermal Design Integration” can be used to produce a graphical display of exclusion zones dictated by ventilation requirements, the area with optimum climate control and hot spots

Ready for Industry 4.0

- Intelligent interfaces and software
- Simple incorporation of cooling units into huge range of IoT applications using the Rittal IoT interface (optional)
- New applications and smart services can therefore be achieved

Efficient and flexible

- Excellent energy efficiency thanks to the innovative hybrid technology of the Blue e+ principle
- Suitable for international use due to unique multi-voltage capability
- Longer service life of components due to component-friendly cooling



VX25 BLUE E+ INTEGRATION SOLUTION

The perfect symbiosis of the VX25 baying enclosure system
and Blue e+ cooling unit



SYSTEM ACCESSORIES – MORE **INSTALLATION OPTIONS**

CONTENTS

Base/plinth	from page 80
Walls	from page 94
Baying system	from page 104
Door variants	from page 108
Lock systems	from page 118
Door installation	from page 124
Roof	from page 132
Mounting plates	from page 138
Rail systems	from page 148
Interior installation	from page 160
Cable management	from page 180
482.6 mm (19") installation system	from page 190
Technical information	from page 197
Technical details	from page 200





Base/plinth system VX



Integral centring aid
The centring aid for base/plinth mounting on the enclosure frame ensures precise positioning of the enclosure on the base/plinth.

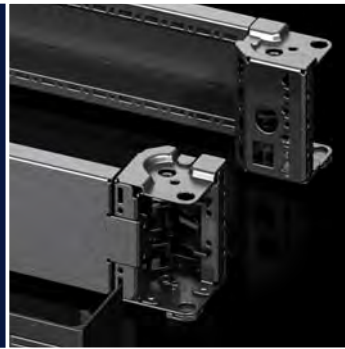

Separate trim panels
The clip-in trim panels allow simple, fast access to the base/plinth for individual use, e.g. as a cable chamber.



Enclosure attachment
The nuts integrated into the base/plinth corner piece allow screw-fastening directly from above, through the stable base frame, or from below, into the enclosure corner piece.

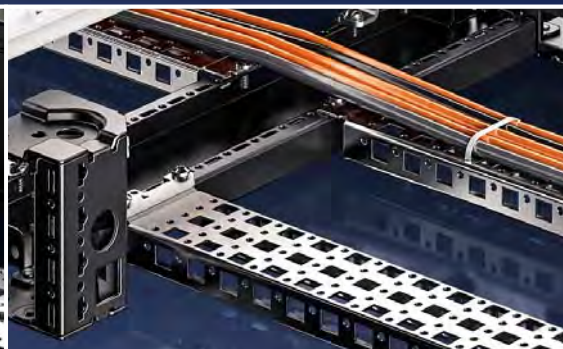

Simple cable management
Secure cable attachment and cable routing via the punched section with mounting flange in the base/plinth.



Additional cable chamber
Gain space with simple integration of the cable clamping rail and C rail for secure, user-friendly cable routing.

Base/plinth system VX

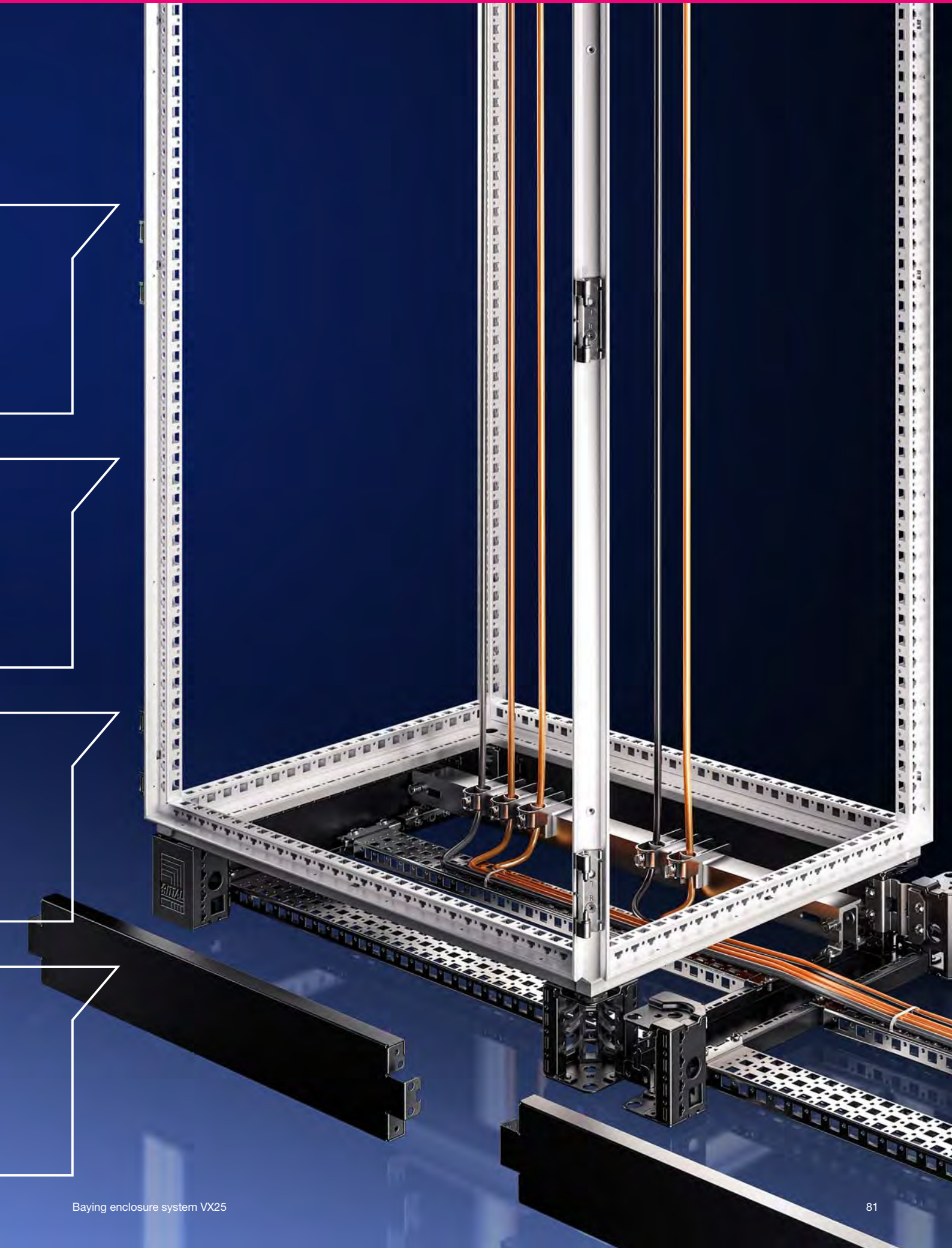

Base/plinth system VX



Base/plinth system VX

All trim panels may optionally be clipped into the corner piece, or securely screw-fastened. Depending on the application, users can dispense with the trim panels between bayed enclosure suites, or a 100 mm high trim panel may be used to stabilise the base/plinth corner pieces.



Trim panels

The solid trim panels supplied as standard are easily replaced with vented trim panels or trim panels with brush strips. Two 100 mm high trim panels may also be used in a 200 mm high base/plinth.



Twin castors

The twin castors may be screw-fastened directly to the enclosure corner piece from the outside. Mounting on the VX base/plinth system is also supported via an adaptor.



Transportation

Easily transported by forklift or lifting truck with the front trim panel removed, even with bayed enclosures.



Base mounting plate

With the base mounting plate, the base/plinth is easily and securely attached to its final position on the floor, even retrospectively with the enclosure already fitted. Assembly occurs via the large base opening in the enclosure.



Levelling component

The levelling component may be used for retrospective levelling on uneven floors. Unevenness of up to 15 mm can be compensated in this way.

Base/plinth system VX

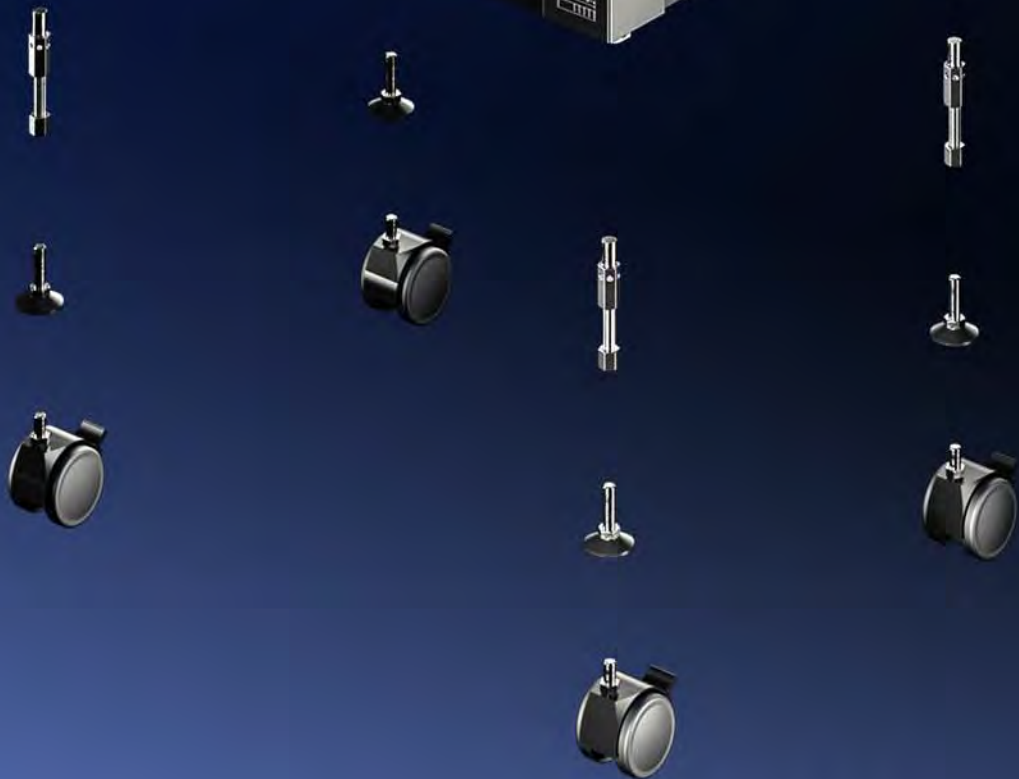
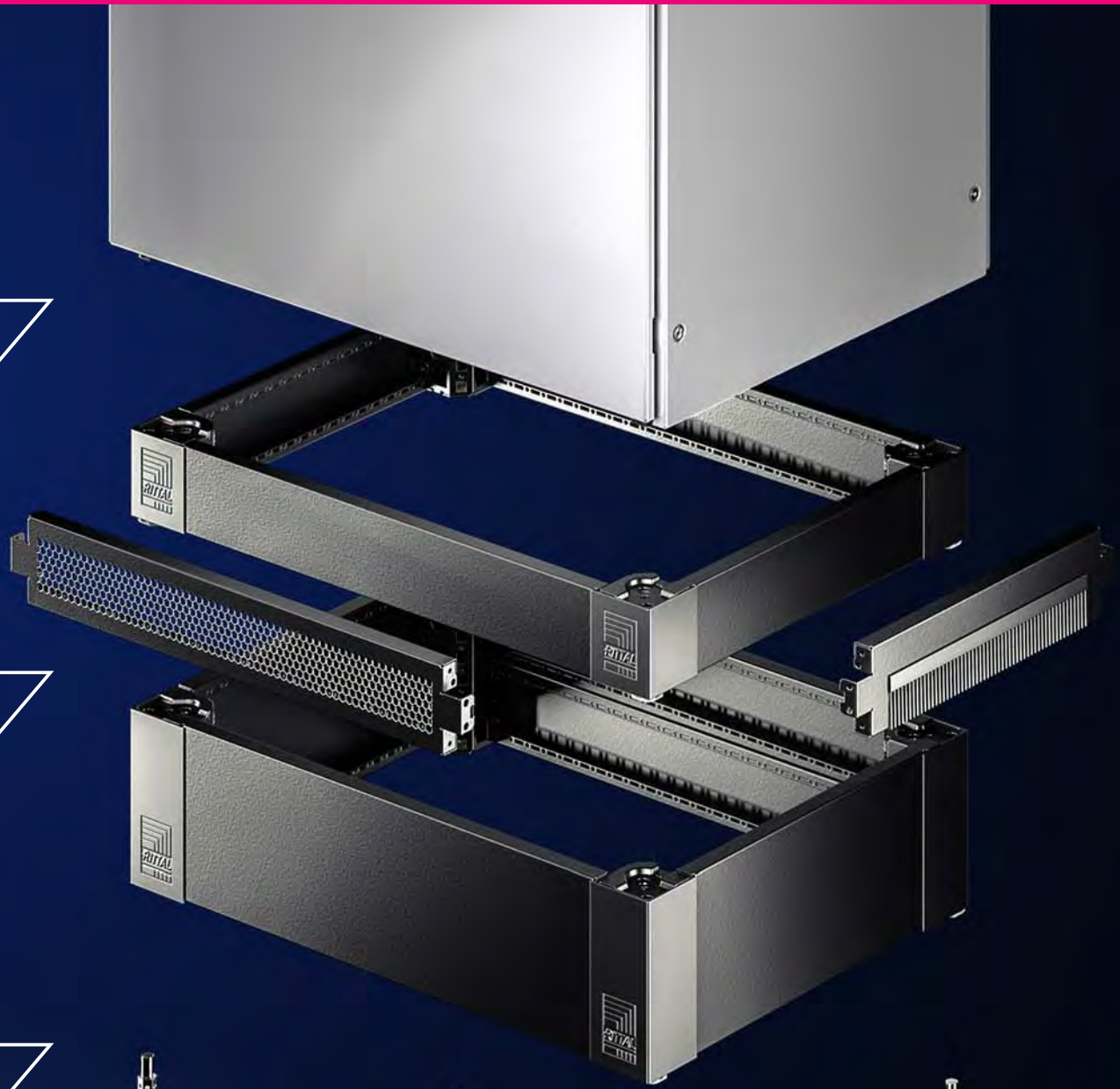

Base/plinth

Base/plinth system VX

Modular base/plinth diversity

The new, innovative base/plinth system VX offers an unprecedented diversity of functions and applications. It combines all existing base/plinth functions in a single solution, as well as opening up many new applications. As if that weren't enough, it is also backward-compatible with existing enclosure solutions TS, TS IT, SE, PC and IW. In short, it is a base/plinth system.

The base/plinth system VX comprises the following components:

- Base/plinth corner pieces with base/plinth trim panels, front and rear
- Base/plinth trim panels, sides

Thanks to fully symmetrical corner pieces, and by using the same base/plinth trim panels in the width and depth, the system opens up many new applications. For example, the vented trim panels and trim panels with brush strips available as accessories may now optionally be attached at the sides, or exchanged for the front/rear trim panels.

All trim panels may optionally be clipped into the corner piece, or screw-fastened. Depending on the application, for example, users can dispense with the trim panels between bayed enclosure suites, or a 100 mm high trim panel may be used to stabilise the base/plinth corner pieces. In combination with its extensive range of accessories, and thanks to its compatibility with enclosure accessories, the base/plinth system VX offers almost infinite possibilities in terms of siting, transportation, cable routing, cable attachment and base/plinth configuration.

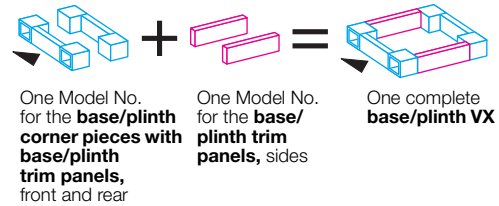

Base/plinth	Basic form	Cable entry options			Stabilisation of bayed base/plinths	
100 mm						
200 mm						

Configuration examples

Order includes	Functional benefits
3 packs Base/plinth corner pieces with base/plinth trim panels 1 pack Base/plinth trim panels, sides, 200 mm high	Continuous cable chamber
3 packs Base/plinth corner pieces with base/plinth trim panels 1 pack Base/plinth trim panels, sides, 200 mm high 1 pack Base/plinth trim panels, sides, 100 mm high 1 pack Baying brackets, internal (8617.500, packs of 6) 4 pc(s). are required for this solution	Additional stability during transportation with base/plinth trim panels rotated through 90°
3 packs Base/plinth corner pieces with base/plinth trim panels 2 packs Base/plinth trim panels, sides, 200 mm high	Shielding of the base/plinths from one another

Other options:

- Cable entry at the side by fitting a 100 mm base/plinth trim panel with brush strip
- Cable entry from the rear by dismantling one or more trim panels from the base/plinth corner pieces and replacing them with trim panels with brush strips
- Cable routing in the base/plinth by using punched sections with mounting flanges on the base/plinth trim panels

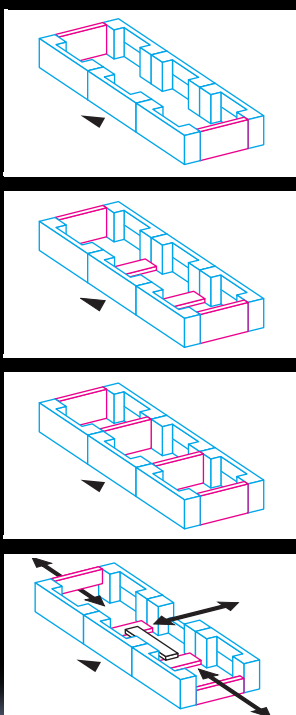

Base/plinth

Base/plinth system VX

Base/plinth corner pieces with base/plinth trim panels, front and rear

Sheet steel

High-load capacity base/plinth corner pieces with moulded self-positioning to the enclosure, may be used with or without base/plinth trim panels depending on the application. Large openings in the corner piece for optimum access to the screw-fastening point, may be concealed with a plastic corner and baying cover.

Material:

- Base/plinth corner piece: Sheet steel
- Base/plinth trim panel front/rear: Sheet steel
- Corner and baying cover: Plastic

Colour:

- RAL 9005

100 mm high supply includes:

- 4 base/plinth corner pieces, 100 mm high
- 4 corner covers
- 1 baying cover
- 2 base/plinth trim panels, front/rear, 100 mm high
- Assembly parts

200 mm high supply includes:

- 4 base/plinth corner pieces, 200 mm high
- 4 corner covers
- 1 baying cover
- 1 base/plinth trim panel, front/rear, 200 mm high
- 2 base/plinth trim panels, front/rear, 100 mm high
- Assembly parts

100 mm high

For enclosure width mm	Model No.
300	8620.000
400	8620.001
600	8620.002
800	8620.003
850	8620.004
1000	8620.005
1100	8620.006
1200	8620.007
1600	8620.008
1800	8620.009

200 mm high

For enclosure width mm	Model No.
300	8620.020
400	8620.021
600	8620.022
800	8620.023
1000	8620.024
1200	8620.025
1600	8620.026
1800	8620.027



Also required:

- Base/plinth trim panels, sides, to finish off a unit, for additional stabilisation between base/plinths, or for interior configuration, see page 86



Accessories:

- Base/plinth trim panels with brush strip, see page 86
- Base/plinth trim panels, vented, see page 87
- Base/plinth installation bracket, see page 89
- Levelling component for base/plinth, see page 89
- Base mounting plate, see page 88
- Base/plinth adaptor for twin castors and levelling feet, see page 92
- Baying bracket, internal, see page 106
- Transport castors for base/plinth VX, see page 88

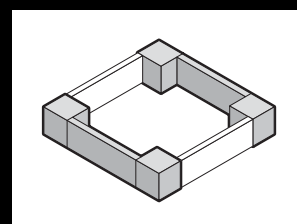

Base/plinth

Base/plinth system VX

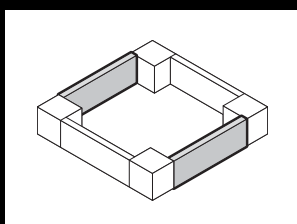

Base/plinth trim panels, sides

Sheet steel

To finish off a base/plinth unit at the sides and for additional stabilisation or for the interior configuration of bayed base/plinths. One 200 mm high or two 100 mm high trim panels may optionally be fitted on 200 mm high base/plinths.

Material:

- Sheet steel

Colour:

- RAL 9005

Supply includes:

- 2 base/plinth trim panels
- Assembly parts

100 mm high

For enclosure depth mm	Model No.
300	8620.030
400	8620.031
500	8620.032
600	8620.033
800	8620.034
1000	8620.035
1200	8620.036

200 mm high

For enclosure depth mm	Model No.
300	8620.040
400	8620.041
500	8620.042
600	8620.043
800	8620.044
1000	8620.045
1200	8620.046

+ Accessories:

- Base/plinth installation bracket, see page 89

⇌ Possible alternative:

- Base/plinth trim panels with brush strip, see page 86
- Base/plinth trim panels, vented, see page 87

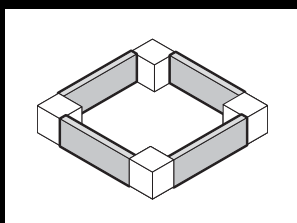

Base/plinth trim panels with brush strip

Sheet steel

For cable entry in the base/plinth. With a base/plinth height of 200 mm, one or two trim panels with brush strips may optionally be used. Thanks to the complete symmetry of the base/plinth system VX, the trim panels with brush strip may either be fitted at the front, rear or side on the base/plinth corner piece.

Material:

- Base/plinth trims: Sheet steel
- Brush strip: Plastic, self-extinguishing

Colour:

- RAL 9005

Supply includes:

- 2 base/plinth trim panels with brush strip
- Assembly parts

For enclosure width/depth mm	Model No.
600	8620.092
800	8620.093
1000	8620.094
1200	8620.095

Base/plinth

Base/plinth system VX

Base/plinth trim panels, vented

Sheet steel

For venting the enclosure via the base/plinth. Specifically in applications such as power distribution where the enclosure gland plates are not used, this can be used to achieve a higher air throughput inside the enclosure. Various solutions to raise the roof and special roof plates with vent openings are also available for enclosure venting. With a 200 mm base/plinth height, one or two vented trim panels may optionally be used. Thanks to the complete symmetry of the base/plinth system VX, the vented trim panels may either be fitted at the front, rear or side on the base/plinth corner piece.

Material:

- Sheet steel

Colour:

- RAL 9005

Supply includes:

- 2 base/plinth trim panels, vented
- Assembly parts for mounting on the base/plinth corner piece

For enclosure width/depth mm	Model No.
600	8620.090
800	8620.091



Accessories:

- Base/plinth installation bracket, see page 89
- Spacers for lifting the roof, see page 135
- Roof plate with vent holes, see page 136

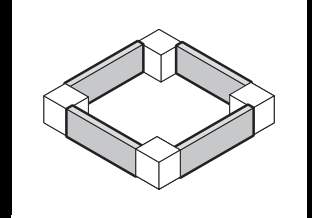

Base/plinth corner pieces with base/plinth trim panels, front and rear

Stainless steel

High-load capacity base/plinth corner pieces with moulded self-positioning to the enclosure, may be used with or without trim panels depending on the application. Large openings in the base/plinth corner piece for optimum access to the screw-fastening point, may be concealed with a plastic corner and baying cover.

Material:

- Base/plinth corner piece: Stainless steel 1.4301 (AISI 304)
- Base/plinth trim panel front/rear: Stainless steel 1.4301 (AISI 304)
- Corner and baying cover: Plastic

Surface finish

- Trim panels: Brushed, grain size 400

100 mm high supply includes:

- 4 base/plinth corner pieces, 100 mm high
- 4 corner covers
- 1 baying cover
- 2 base/plinth trim panels, front/rear, 100 mm high
- Assembly parts

200 mm high supply includes:

- 4 base/plinth corner pieces, 200 mm high
- 4 corner covers
- 1 baying cover
- 1 base/plinth trim panel, front/rear, 200 mm high
- 2 base/plinth trim panels, front/rear, 100 mm high
- Assembly parts

For enclosure width mm	Height mm	Model No.
600	100	8620.050
800	100	8620.051
1000	100	8620.052
1200	100	8620.053
600	200	8620.060
800	200	8620.061
1000	200	8620.062
1200	200	8620.063



Also required:

- Base/plinth trim panels, sides, to finish off a unit, for additional stabilisation between base/plinths, or for interior configuration, see page 88



Accessories:

- Base/plinth installation bracket, see page 89
- Levelling component for base/plinth, see page 89
- Base mounting plate, see page 88
- Base/plinth adaptor for twin castors and levelling feet, see page 92
- Transport castors for base/plinth, see page 88

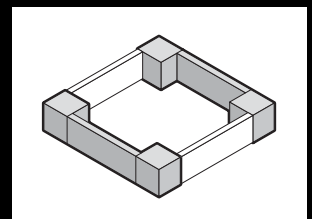

Base/plinth

Base/plinth system VX

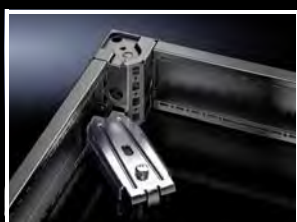
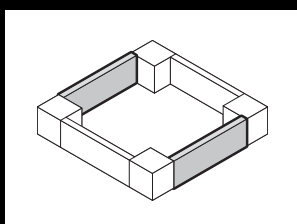

Base/plinth trim panels, sides

Stainless steel

To finish off a base/plinth unit at the side and for additional stabilisation or for interior configuration of bayed base/plinths. One 200 mm high or two 100 mm high trim panels may optionally be fitted on 200 mm high base/plinths.

Material:

- Base/plinth trim panels: Stainless steel 1.4301 (AISI 304)

Surface finish:

- Brushed, grain size 400

Supply includes:

- 2 base/plinth trim panels
- Assembly parts

For enclosure depth mm	Height mm	Model No.
400	100	8620.070
500	100	8620.071
600	100	8620.072
400	200	8620.080
500	200	8620.081
600	200	8620.082



Accessories:

- Base/plinth installation bracket, see page 89

Transport castors

For locating onto the base/plinth corner piece, 100 or 200 mm high.

Load capacity:

- Maximum permissible load per twin castor: 1000 N

Supply includes:

- 4 twin castors, 2 x with, 2 x without locks

Colour:

- RAL 9005

Floor clearance mm	Model No.
100	8100.700



Accessories:

- Base/plinth trim panels, sides, for stabilisation, see page 86

Base mounting plate

For attaching the base/plinth to the floor. For assembly screws up to 12 mm Ø.

Material:

- Sheet steel

Surface finish:

- Zinc-plated

P. of	Model No.
10 pc(s).	2817.000

Base/plinth

Base/plinth system VX

Base/plinth installation bracket for base/plinth system VX, sheet steel and stainless steel

For configuring the base/plinth with punched sections with mounting flanges or cable clamp rails. To fit 100 and 200 mm high base/plinth trim panels in sheet steel and stainless steel.

Material:

- Stainless steel 1.4301 (AISI 304)

Supply includes:

- 2 installation brackets
- 2 mounting brackets for cable clamp rail
- Assembly parts

Note:

- For interior installation on upright base/plinth trim panels
- For base/plinth trim panels rotated through 90°, the installation bracket is not needed, because in this position, the system punchings of the base/plinth trim panels may be used directly.

- 1 Installation bracket with mounting bracket for cable clamp rail
- 2 Cable clamp rail
- 3 Installation bracket
- 4 Punched section with mounting flange, 23 x 89 mm
- 5 Base/plinth trim panel, rotated through 90°

For base/plinth trim panel height mm	P. of	Model No.
100	2 pc(s).	8620.400
200	2 pc(s).	

+ Accessories:

- Punched section with mounting flange, 23 x 64 mm, see page 150
- Punched section with mounting flange, 23 x 89 mm, see page 151
- Cable clamp rail, see page 187

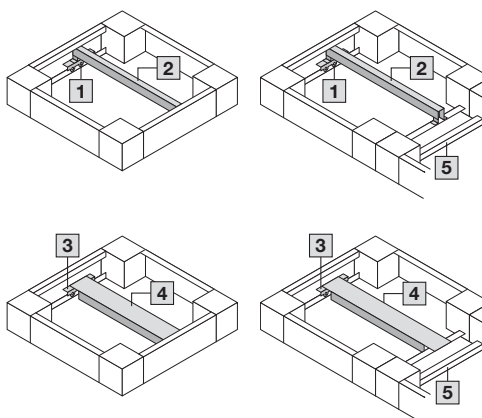

Levelling component

For retrospective levelling on uneven floors at the installation site up to a maximum of 15 mm. Installed through the base/plinth corner piece. Adjusted using a hex spanner, width across flats 19 mm.

Benefits:

- A door offset caused by uneven flooring can be corrected
- Installed on the assembled enclosure, i.e. no need to plan levelling in advance

Load capacity:

- Max. admissible load: 2500 N per levelling component (check the load capacity of the floor).

Supply includes:

- Assembly parts

For base/plinth height mm	P. of	Model No.
100	4 pc(s).	8100.710
200	4 pc(s).	8100.711



Base/plinth

Base/plinth system VX

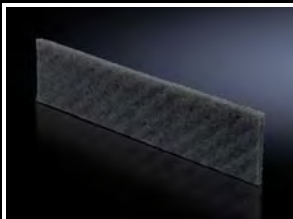
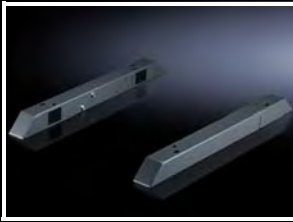

Cross member

Adjustable

- To increase stability
- Height 70 mm
- Adjustable to the enclosure depth

To increase stability, the cross member is positioned below the base frame of the enclosure and protrudes 138 mm at the front and rear. For deeper enclosures, the rear part may be extended and screw-fastened again. For screw-fastening to the floor and enclosure with mounting hole at the sides, front and rear. The castors and levelling feet may be secured to the welded nuts M12.

Material:

- Sheet steel

Surface finish:

- Spray-finished

Colour:

- RAL 7015

For enclosure depth mm	Model No.
400	8601.450
500	
600	8601.680
800	

+ Accessories:

- Twin castors 6148.000, 7495.000, see page 91
- Levelling feet 4612.000, see page 91

Assembly instruction:

- Ensure sufficient stability to prevent the enclosure from tipping over

Filter mat

for base/plinth trim panel, vented

The filter mat is simply inserted into the trim panel from the rear.

Supply includes:

- 1 roll, length 3 m, may be shortened to required length

P. of	Model No.
1 pc(s).	8620.100

Levelling feet

18 – 43 mm high

To compensate for height differences with floor irregularities. Mounting thread M12.

Load capacity:

- Max. admissible load: approx. 3000 N per levelling foot

Material	P. of	Model No.
Sheet steel	4 pc(s).	4612.000
Stainless steel	4 pc(s).	8100.780



Also required:

- For mounting on the base/plinth: Base/plinth adaptor, see page 92



Levelling feet

85 – 115 mm high

For mounting on enclosures, for easier floor cleaning and to compensate for floor irregularities ±15 mm.

Load capacity:

- Max. admissible load: 3500 N per levelling foot

Material:

- Stainless steel 1.4301 (AISI 304)

Supply includes:

- Assembly parts

P. of	Model No.
4 pc(s).	2859.000



Twin castors

For mobile use, for mounting directly on the enclosure. Mounting thread M12 x 20.



Also required:

- For mounting on the base/plinth: Base/plinth adaptor for twin castors, see page 92

	Maximum admissible load (per castor)	750 N
	Floor clearance	85 mm
[1]	Lock	2 with, 2 without
	P. of	4 pc(s).
	Colour	Black with grey running surface
	Model No.	6148.000

	Maximum admissible load (per castor)	1200 N
	Floor clearance	125 mm
[2]	Lock	2 with, 2 without
	P. of	4 pc(s).
	Colour	Black
	Model No.	7495.000



Base



Base/plinth adaptor

for twin castors and levelling feet

For mounting twin castors and levelling feet to the base/plinth.

Material	P. of	Model No.
Sheet steel	4 pc(s).	8100.770
Stainless steel	4 pc(s).	8100.771

Note:

- When fitting twin castors, side trim panels, see page 86, are required.



System divider

Divides the enclosure width into two zones. In this way, for example, mounting plates, cable clamp rails or swing frames from 600 mm wide enclosures can be fitted in 1200 mm wide enclosures.

Depth	P. of	Model No.
500	2 pc(s).	8620.900
600	2 pc(s).	8620.901

Material:

- Sheet steel

Surface finish:

- Zinc-plated

Supply includes:

- Assembly parts



Accessories:

- Swing frame mounting kit, see page 194
- Cable clamp rail, see page 187
- Support rails 48 x 26 mm, see page 152

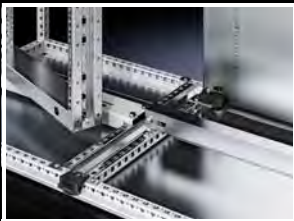
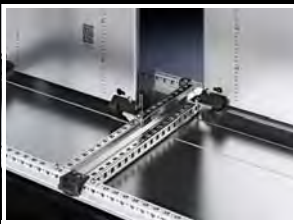

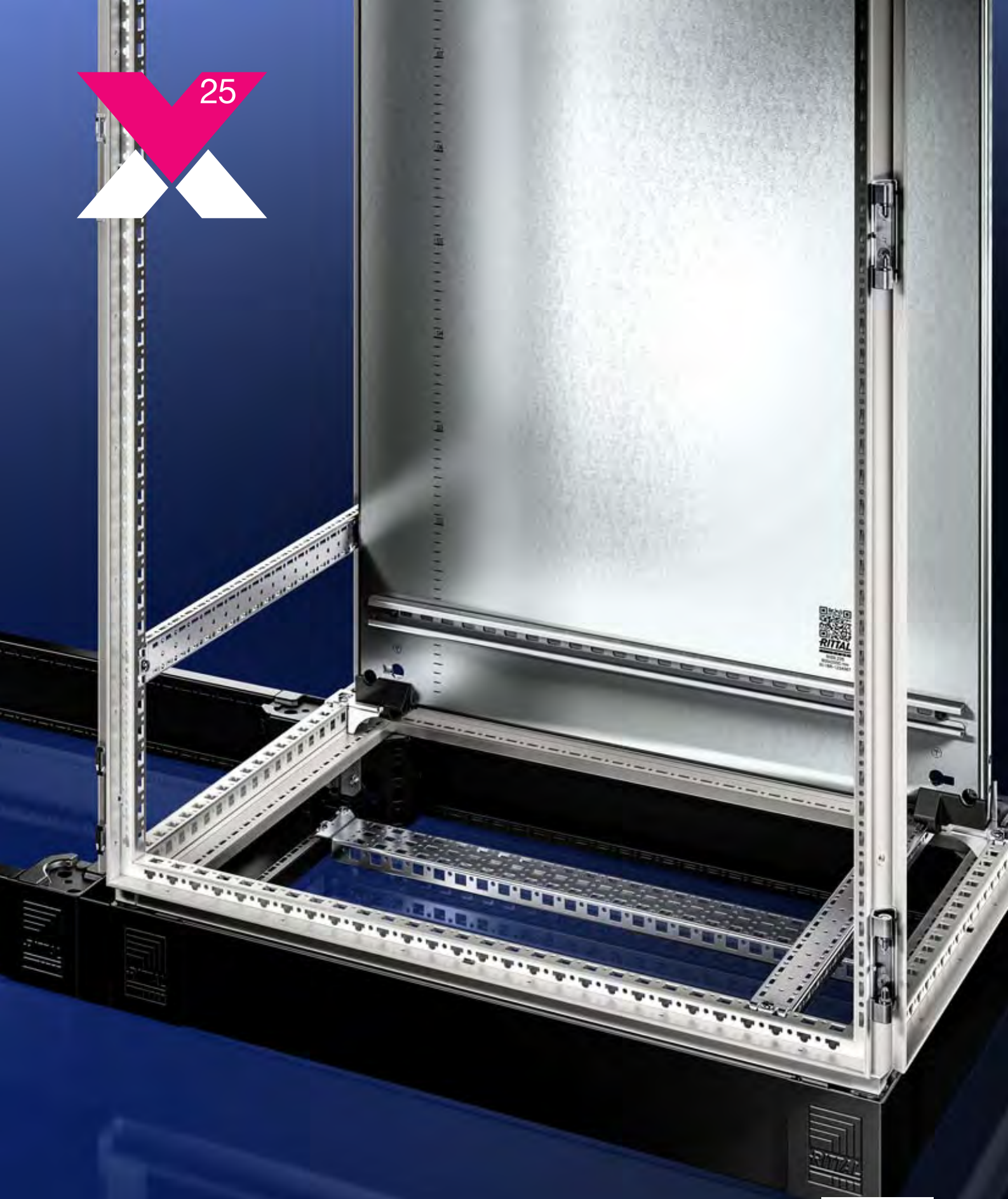

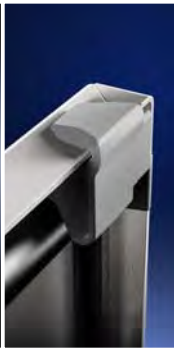

Side panels
Simple one-man installation with the positioning aid provided as standard.

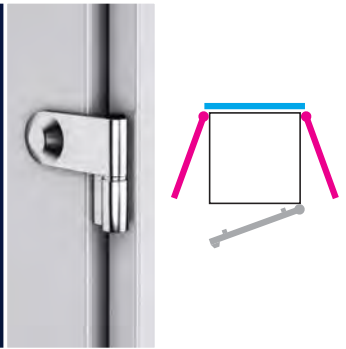

Hinge
The hinge for side panels provides unhindered access from the side at any time, so the side panel can be opened at an angle of 180°.

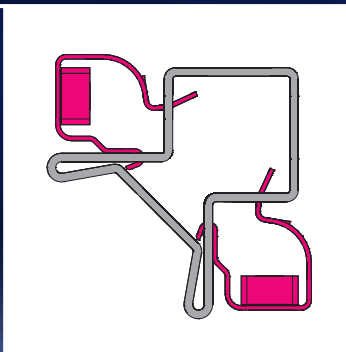

Side panel holder
The side panel holders are easily retro-fitted and removed at any time because they simply clip into position from the outside, even with the rear panel fitted. Internal earthing inserts ensure automatic potential equalisation, while at the same time guaranteeing enhanced EMC protection.



Divider panel for module plates
A complete system comprised of a divider panel, module plates and adaptors, and even a cover with a door, is available for mounting heavy connectors. It goes without saying that the door can also be integrated into the complete lock system, with all its variants.

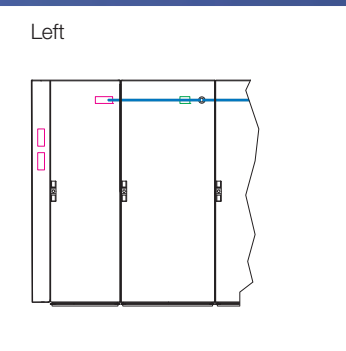
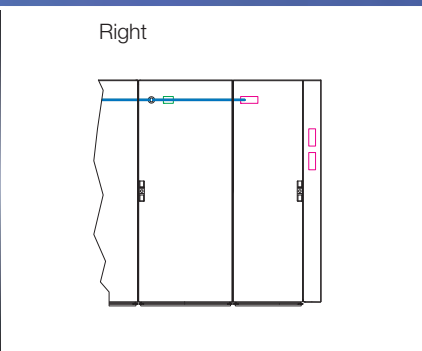

Isolator door cover
The solution for all switchgear subject to the requirements of UL 508 A for bayed enclosure suites. The isolator door cover can be used on the left or right, and is finished off with the standard side panel.



Walls

Side panels



Side panels, screw-fastened, sheet steel

- Time-saving assembly thanks to clip-in side panel holders
- Automatic potential equalisation and higher EMC protection, thanks to enclosure panel holders with earthing inserts located on the inside
- Easy positioning in the height and depth with the location aid
- One-person assembly
- Earthing bolts with large, paint-free contact surface for optimum contact

Material:

- Sheet steel, 1.5 mm

Surface finish:

- Dipcoat-primed, powder-coated on the outside

Colour:

- RAL 7035

Protection category IP to IEC 60 529:

- IP 55

Supply includes:

- Assembly parts

For enclosures		P. of	Model No.
Height mm	Depth mm		
1200	500	2 pc(s).	8115.245
1400	500	2 pc(s).	8145.245
1600	500	2 pc(s).	8165.245
1600	600	2 pc(s).	8166.245
1600	800	2 pc(s).	8168.245
1800	400	2 pc(s).	8184.245
1800	500	2 pc(s).	8185.245
1800	600	2 pc(s).	8186.245
2000	400	2 pc(s).	8104.245
2000	500	2 pc(s).	8105.245
2000	600	2 pc(s).	8106.245
2000	800	2 pc(s).	8108.245
2200	600	2 pc(s).	8126.245
2200	800	2 pc(s).	8128.245



Accessories:

- Hinge for side panel, screw-fastened, sheet steel, see page 97



Side panels, screw-fastened, stainless steel

- Time-saving assembly thanks to clip-in side panel holders
- Automatic potential equalisation and higher EMC protection, thanks to enclosure panel holders with earthing inserts located on the inside
- Easy positioning in the height and depth with the location aid
- One-person assembly
- Earthing bolts with large, paint-free contact surface for optimum contact

Material:

- Stainless steel 1.4301 (AISI 304), 1.5 mm

Surface finish:

- Brushed, grain size 400

Protection category IP to IEC 60 529:

- IP 55

Supply includes:

- Assembly parts

For enclosures		P. of	Model No.
Height mm	Depth mm		
1800	400	2 pc(s).	8700.030
1800	500	2 pc(s).	8700.040
2000	600	2 pc(s).	8700.050

Hinges

for side panel, screw-fastened, sheet steel

The 180° opening angle allows unhindered access from the side.

Material:

- Die-cast zinc

Colour:

- RAL 7035

Protection category IP to IEC 60 529:

- IP 55

Supply includes:

- Assembly parts

P. of	Model No.
6 pc(s).	8106.260

Note:

- Hinge mounting (red) is only possible in the vicinity of the rear panel (blue)

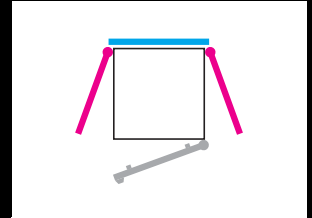

Walls

Divider panels/partitions

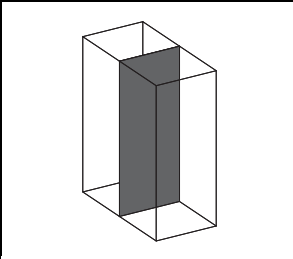

Divider panel

For shielding individual enclosure cells. Thanks to the symmetry of the frame system, the divider panel can also be used at the rear. All-round, double fold for stability and to hold the seal.

Material:

- Sheet steel, 1.5 mm

Surface finish:

- Zinc-plated

Protection category IP to IEC 60 529:

- IP 54

Supply includes:

- Assembly parts



Also required:

- When buying in conjunction with a divider panel:
Baying bracket, internal 8617.500, see page 106
or
baying connector, external 8617.502, see page 106



Accessories:

- Cover with door, see page 101

For enclosures		Model No.
Height mm	Depth mm	
1800	400	8609.200
1800	500	8609.201
1800	600	8609.202
2000	400	8609.203
2000	500	8609.204
2000	600	8609.205
2000	800	8609.206
2200	600	8609.207

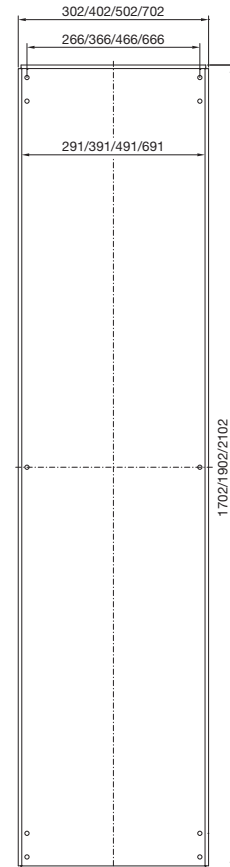

Divider panels/partitions

Divider panel

for module plates

With cut-outs for the installation of module plates for connectors or for cable entry, and also for the entry of busbar systems and other installed equipment. All-round, double fold for stability and to hold the seal. Thanks to the symmetry of the enclosure frame, divider panels may also be fitted at the rear, dimensions permitting.

Material:

- Sheet steel, 2 mm

Surface finish:

- Zinc-plated

Supply includes:

- Assembly parts



Also required:

- When buying in conjunction with a divider panel:
Baying bracket, internal 8617.500, see page 106
or
baying connector, external 8617.502, see page 106



Accessories:

- Module plates, see page 100
- Cover with door, see page 101
- Baying bracket, internal, see page 106

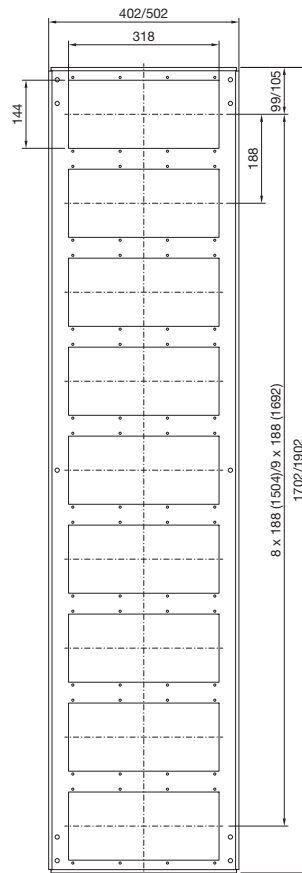

For enclosures		Number of cut-outs	Model No.
Height mm	Depth mm		
1800	500	9	8609.210
1800	600	9	8609.211
2000	500	10	8609.212
2000	600	10	8609.213

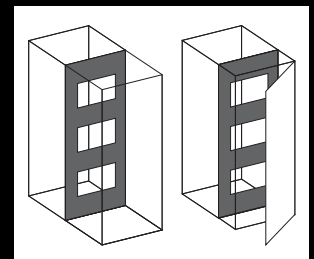
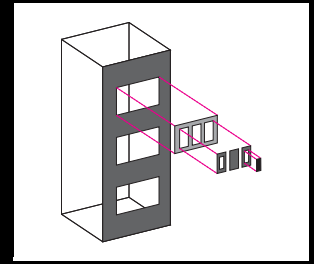

Walls

Divider panels/partitions

Module plates

Material:

- Sheet steel, 2 mm

Surface finish:

- Zinc-plated

Supply includes:

- Seal

Version	Cut-outs	P. of	Model No.
Solid	-	1 pc(s).	8609.160
For 16-pole connectors	4	1 pc(s).	8609.150
For 24-pole connectors	4	1 pc(s).	8609.140
For cable entry	1	1 pc(s).	8609.170
With cable sleeve	1	1 pc(s).	8609.390



Solid

For sealing unused cut-outs. Easily machined for individual cut-outs.



For 16/24-pole connectors

With cut-outs to accommodate connectors.



Accessories:

- Adaptor, cover plate, see page 101
- Connector gland for connector cut-outs, see page 101
- Connector gland sealing frame and sealing module, see page 185



For cable entry

For inserting pre-assembled cables. Sealed, secure routing is achieved via adjustable angle brackets with inserted foam cable clamp strip. Fixed bracket, slotted, for cable clamping.



Accessories:

- Cable tie for fast assembly 2597.000, see page 188

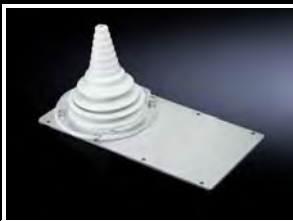

With cable sleeve

For cable diameters from 10 to 65 mm. The flexible grommet adapts to the cable's bending radius.

Divider panels/partitions

Adaptor

for connector cut-outs

For using connectors with varying numbers of poles.

Material:

– Sheet steel

Surface finish:

– Zinc-plated

Supply includes:

– Seal and assembly parts

For reduction	P. of	Model No.
from 24 to 16 poles	5 pc(s).	2479.000
from 24 to 10 poles	5 pc(s).	2480.000
from 24 to 6 poles	5 pc(s).	2481.000
from 16 to 10 poles	5 pc(s).	2401.000
from 16 to 6 poles	5 pc(s).	2402.000



Cover plate

for connector cut-outs

For unused cut-outs.

Material:

– Sheet steel

Surface finish:

– Zinc-plated

Supply includes:

– Seal and assembly parts

For	P. of	Model No.
24-pole cut-outs	20 pc(s).	2477.000
16-pole cut-outs	20 pc(s).	2478.000



Connector gland

for connector cut-outs (24-pole)

For inserting 2 pre-assembled cables through the connector cut-out, without dismantling the cable connector.

Cable diameter: 8 – 36 mm

Material:

– Case: Plastic

– Clamps: Sheet steel

Surface finish:

– Clamps: Zinc-plated

Supply includes:

– Assembly parts

P. of	Model No.
1 pc(s).	2400.000



Cover with door

- To protect and finish off connectors or other installed equipment
- Optional cable entry from above or below

Material:

– Cover: Sheet steel, 1.5 mm

– Door: Sheet steel, 2.0 mm

Surface finish:

– Spray-finished

Colour:

– RAL 7035

Protection category IP to IEC 60 529:

– IP 55

Protection category to NEMA:

– NEMA 12

Supply includes:

- Cover
- Door with locking rod and double-bit lock insert
- 2 trim panels for top and bottom

For enclosures		Model No.
Height mm	Depth mm	
2000	500	8609.220
2000	600	8609.230

Accessories:

- Lock inserts, type G, see page 121
- Comfort handle, see page 120
- 180° hinge, see page 111



Walls

Isolator door lock



Isolator door cover

Including main door latch for safety locking of enclosures and bayed enclosure suites in accordance with UL regulations. Tested in conjunction with actuator lever for master switch from the following companies:

- Allen Bradley
- Square D
- General Electric
- Eaton
- Siemens

A detailed overview of types can be found on the Internet, together with the product description.

Benefits:

- Meets the requirements of UL 508 A
- In conjunction with the operating mechanism, adjacent door lock and interconnecting rods, these requirements are also met for bayed combinations
- Optional mounting on the left or right of the enclosure. With this cover, all single-door bayed enclosures may be configured as isolator door enclosures. The complete installation surface of the enclosure is retained.
- In conjunction with the integrated mounting plate infill, the mounting surface of the main enclosure can be enlarged by up to 14%
- Two cut-outs for actuator levers on the front, for internal mounting at varying heights

Material:

- Sheet steel, 1.5 mm

Surface finish:

- Powder-coated

Colour:

- RAL 7035

Protection category IP to IEC 60 529:

- IP 55

Protection category to NEMA:

- NEMA 12

Supply includes:

- Main door lock, cover plate and assembly parts

Note:

- Cover may only be mounted on a single-door enclosure with tubular door frame

Width mm	Height mm	Depth mm	Model No.
125	1800	400	8951.020
125	1800	500	8951.030
125	2000	500	8951.000
125	2000	600	8951.010



Also required:

- Operating mechanism 4912.000, for enclosure with isolator door cover and additionally in every fourth adjacent enclosure, see page 103
- Adjacent door latch 4911.000, 4911.100, for every adjacent enclosure, see page 103
- Interconnecting rods, for every adjacent enclosure in the appropriate enclosure width, see page 103
- Side panel, screw-fastened, see page 96



Accessories:

- Mounting plate infill, see page 141

Isolator door locking

- 1 Operating mechanism
- 2 Adjacent door latch (single-door)
- 3 Interconnecting rod
- 4 Connection component
- 5 Main door latch
- 6 Adjacent door latch (two-door)
- 7 Side panel, screw-fastened

Installation to the right of the enclosure

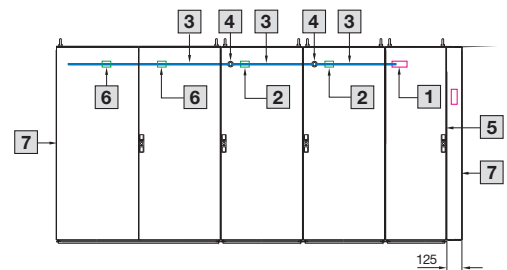

Door latch for bayed enclosure suites

In conjunction with the isolator door cover, the requirements of UL 508 A are also met for bayed enclosure suites. Depending on the baying combination, different components will be required; refer to the assembly sketch on page 102.

Note:

- The door latch for bayed enclosure suites can also be used without the isolator door cover and in combination with commercially available master switches. In this way, adjacent doors cannot be opened until the main door has been opened.

1 Operating mechanism

Fitted in the enclosure with main switch and additionally in every fourth adjacent enclosure

	P. of	Model No.
Operating mechanism	1 pc(s).	4912.000

2 Adjacent door latch

Fitted in the adjacent enclosure

Adjacent door latch for	P. of	Model No.
Single-door enclosures	1 pc(s).	4911.000
Two-door enclosures	1 pc(s).	4911.100

3 Interconnecting rods

To extend locking from the main enclosure to the adjacent enclosures of a bayed suite. One interconnecting rod corresponding to the width of the enclosure is required for each adjacent enclosure.

For enclosure width mm	P. of	Model No.
600	10 pc(s).	4916.000
800	10 pc(s).	4918.000
1200	10 pc(s).	4920.000

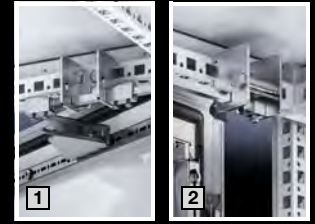

Baying system



Baying connector, external
Simple baying on the vertical sections, even retrospectively, if installed equipment makes it difficult or impossible to bay from the inside.



Baying block, internal
Flexible positioning at the baying point, flush with the enclosure section on a 25 mm pitch pattern. Top-mounting of the baying block is easily achieved. Enclosures are easily pushed together.



Baying cover, top
Reliably protects the baying point at the top to prevent the accumulation of dirt and liquids.



Baying seal
Fast, secure-fit, all-round attachment of the baying seal onto the section edge; easily removed at any time without leaving any residues. Lends itself readily to reuse.



Baying bracket, internal

For flexible positioning at the baying point on a 25 mm pitch pattern, thereby avoiding collisions with equipment installed across multiple enclosures. The option of screw-fastening the baying bracket from the side makes it easy to push enclosures together.

Combination angle

The combination angle can be exchanged for the roof attachment screw, to ensure optimum load distribution among the enclosure corner points when bayed enclosure suites are transported by crane.

Baying base/plinth corner pieces

The internal baying bracket can also be used for stable baying of base/plinth corner pieces in the base/plinth system VX.

Baying kit, VX25 to TS 8

Ensures the secure baying of a VX25 when extending existing TS 8 enclosure suites.



Baying system

Baying

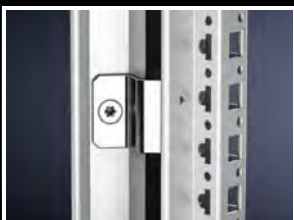
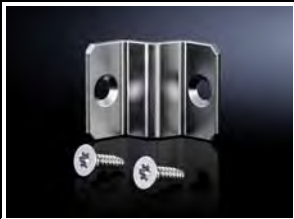

Baying bracket, internal

- Fast, secure installation either from the front or from the side
- For all-round installation on the baying joint
- May be flexibly positioned to avoid collisions with installed equipment
- Also suitable for baying base/plinth components

Material:

- Sheet steel

Surface finish:

- Zinc-plated

Supply includes:

- Baying bracket, internal
- Baying seal
- Assembly parts

P. of	Model No.
6 pc(s).	8617.500

Note:

- 1 pack is sufficient for one baying joint

Possible alternative:

- Baying block, internal, see page 106
- Baying connector, external 8617.502, see page 106

Baying block, internal

- Side mounting creates a flush surface to the extrusion, suitable for top mounting, thus avoiding collisions with installed equipment
- For all-round installation on the baying joint

Material:

- Die-cast zinc

Supply includes:

- Baying block, internal
- Baying seal
- Assembly parts

P. of	Model No.
6 pc(s).	8617.501

Note:

- 1 pack is sufficient for one baying joint

Possible alternative:

- Baying bracket, internal, see page 106
- Baying connector, external 8617.502, see page 106

Baying connector, external

For mounting on the vertical enclosure sections from the outside.

Supply includes:

- Baying connector, external
- Baying seal
- Assembly parts

Material	P. of	Model No.
Sheet steel, zinc-plated	6 pc(s).	8617.502
Stainless steel 1.4301 (AISI 304)	6 pc(s).	8617.503

Note:

- 1 pack is sufficient for one baying joint

Possible alternative:

- Baying bracket, internal, see page 106
- Baying block, internal, see page 106

Baying system

Baying

Combination angle

For optimum distribution of tensile forces during transportation of bayed enclosures by crane.

Material:

- Sheet steel

Surface finish:

- Zinc-plated

Supply includes:

- Assembly parts

P. of	Model No.
4 pc(s).	4540.000



Accessories:

- Baying cover, top, see page 107



Baying cover, top

A cover with two end caps may additionally be clipped over the seal between the two enclosures. This prevents dirt and liquid from accumulating on the baying seal.

Supply includes:

- Assembly parts

Note:

- May also be fitted in the width with enclosure suites bayed back-to-back
- May also be used in conjunction with dust guard trim, see page 134

For enclosure depth mm	P. of	Plastic RAL 7035	Stainless steel 1.4301 (AISI 304)	Model No.
400	1 pc(s).	■	-	8800.845
500	1 pc(s).	■	-	8800.855
600	1 pc(s).	■	-	8800.865
800	1 pc(s).	■	-	8800.885
400	1 pc(s).	-	■	8700.140
500	1 pc(s).	-	■	8700.150
600	1 pc(s).	-	■	8700.160



Baying cover, vertical

To balance out the gap between the side panels when baying back-to-back. For enclosure height 2200 mm, or may be cut to length individually for lower heights.

Material:

- Cover section: Plastic

Colour:

- RAL 7035

Supply includes:

- Assembly parts

P. of	Model No.
2 pc(s).	8800.875



Also required:

- Baying connector, external, 8617.502, see page 106

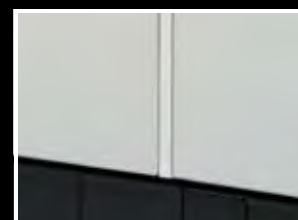

Baying kit, VX25 to TS 8

For extending existing TS 8 bayed enclosure suites with VX25 enclosures.

Material:

- Baying connector: Sheet steel

Supply includes:

- 6 baying connectors
- 1 seal

P. of	Model No.
1 pc(s).	8617.505

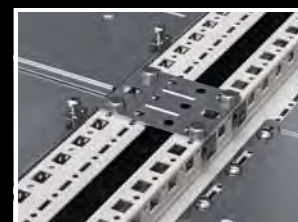

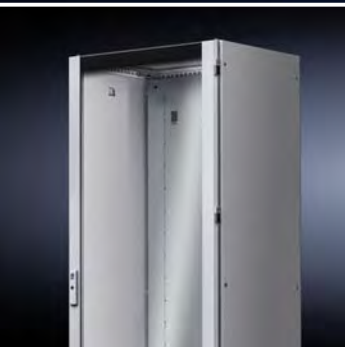

Glazed door

The glazed door easily replaces a sheet steel door, without the need for machining. The single-pane safety glass features a designer grid pattern print at the top and bottom. The glazed door is pre-fitted as standard with 180° hinges.

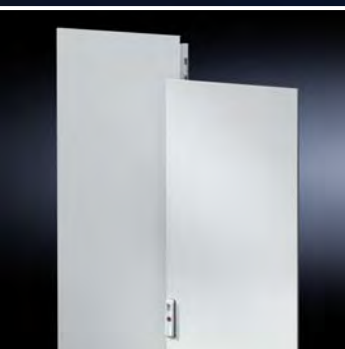

Lockable and adjacent door

In 800 mm wide enclosures, the one-piece standard door may be replaced for a two-piece lockable and adjacent door, so that mandatory escape routes can still be observed in confined spaces. The lockable and adjacent door may also be fitted instead of the rear panel.



Protective bar

In open control systems, the protective bar prevents people from falling into the switchgear. In combination with the hinged trim panel, top, this allows the safe accommodation of display and control components despite the open switchgear.



Modular climate control concept

The modular climate control concept allows cooling unit components up to 2500 W to be integrated into the enclosure door, without the need for machining. The standard door is easily replaced for the modular climate control door. In two-door enclosures, either the lockable door or the adjacent door may be exchanged for a modular climate control door.



Partial doors

Partial doors allow individual configuration of the enclosure front. Sheet steel variants and variants with a viewing window are available.



Transport and mounting handle

The transport and mounting handle is an ergonomic tool to make the fitting and removal of doors easier. It is simply suspended from the tubular door frame.



Doors/locks

Door variants



Glazed door

Instead of a sheet steel door or rear panel.

Material:

- Frame: Extruded aluminium section
- Viewing window: Single-pane safety glass, 3 mm

Surface finish:

- Powder-coated

Colour:

- Frame and corner pieces: RAL 7035
- Viewing window (printed mask on the inside): RAL 9005

Protection category IP to IEC 60 529:

- IP 55

Supply includes:

- Glazed door
- Locking rod with double-bit lock insert
- 180° hinges (4 pc(s).)

For enclosures		Model No.
Width mm	Height mm	
600	1800	8618.000
800	1800	8618.010
600	2000	8618.020
800	2000	8618.030
600	2200	8618.040
800	2200	8618.050



Also required:

- When mounting instead of the rear panel or double door: Lock components for frame 8618.110, see page 110



Accessories:

- Lock system, see page 120

Lock components

For retrofitting a glazed door or sheet steel door in place of a rear panel.

Material:

- Die-cast zinc

Supply includes:

- Assembly parts

P. of	Model No.
4 pc(s).	8618.110

Lockable and adjacent door

For example, if two 400 mm doors instead of one 800 mm wide door are used to comply with escape routes. May also be fitted instead of an 800 mm wide rear panel.

Material:

- Sheet steel

Surface finish:

- Dipcoat-primed, powder-coated on the outside

Colour:

- RAL 7035

Protection category IP to IEC 60 529:

- IP 55

Supply includes:

- 2 doors, including tubular door frame, hinges and lock components

For enclosures		Model No.
Width mm	Height mm	
800	2000	8618.120



Accessories:

- Lock system, see page 120

Doors/locks

Door variants

Protective bar

As an alternative to a door, e.g. in sealed switch rooms. Prevents people from falling into the open enclosure frame. Easily removable for maintenance purposes. For 1200 mm enclosure width; may be shortened or divided for other sizes.

Material:

– Wood, spray-finished, RAL 3000

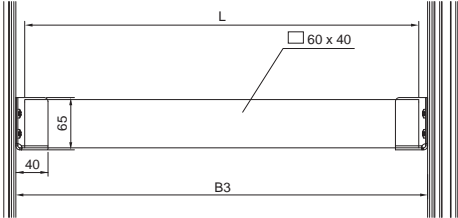

For enclosure width mm	Length mm	P. of	Model No.
1200	1090	1 pc(s).	8801.010

Enclosure width mm	Clearance between the enclosure frame (B3) mm	Length of protective bar (L) mm
400	311	290 ¹⁾
600	511	490 ¹⁾
800	711	690 ¹⁾
1000	911	890 ¹⁾
1200	1111	1090

¹⁾ The protective bar 8801.010 (1090 mm) will need to be shortened



Support

for protective bar

For mounting on the vertical section. The protective bar is simply inserted.

Material:

– Sheet steel

Surface finish:

– Zinc-plated

Supply includes:

– Assembly screws

P. of	Model No.
2 pc(s).	8801.000



180° hinges

- For extending the door opening angle to 180°
- May be mounted without machining the door
- Suitable for door installations up to 900 N

Supply includes:

– Assembly parts

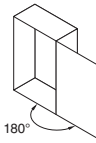
Material	Colour	P. of	 Model No.
Steel/precision-cast	RAL 7035	4 pc(s).	8618.330
Stainless steel/precision-cast	–		8618.340



Modular climate control concept – Cooling module "Blue e"



VX25 enclosures Page 54 Base/plinth VX Page 85

All cooling modules are compatible with all section doors.

Temperature control:
– e-Comfort controller (factory setting +35°C)

Material:
– Sheet steel

Colour:
– RAL 7035

Protection category IP to IEC 60 529:

- External circuit IP 34
- Internal circuit IP 54

Supply includes:

- Cooling module prepared for installation in section door
- Nano-coated condenser
- Integral electric condensate evaporation
- Fully wired ready for connection (plug-in terminal strip)

Note:

- A base/plinth with a height of 100 or 200 mm is required for efficient operation

Approvals:

Available on the Internet

Performance diagrams:

Available on the Internet

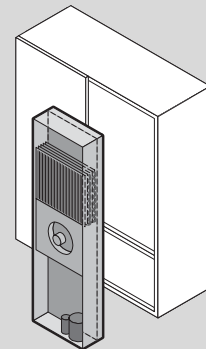

Output class 1500 – 2500 W

Model No.	P. of	3307.700	3307.740	3310.700	3310.740	Page
Material	Sheet steel	■	■	■	■	
Rated operating voltage V, ~, Hz		230, 1~, 50/60	400, 3~, 50 460, 3~, 60	230, 1~, 50/60	400, 3~, 50 460, 3~, 60	
Total cooling output 50/60 Hz L35 L35 kW		1.50 / 1.55	1.50 / 1.55	2.5 / 2.52	2.5 / 2.5	
Total cooling output 50/60 Hz L35 L50 kW		0.85 / 0.9	0.93 / 0.95	1.62 / 1.76	1.76 / 1.8	
Rated max. current A		6 / 6.1	2.5 / 2.7	7.6 / 9.4	3.5 / 3.7	
Start-up current A		22 / 24	8.5 / 9.2	22 / 24	13 / 14	
Pre-fuse A		16	–	16	–	
Motor circuit-breaker A		–	6.3...10	–	6.3...10	
Power consumption P _{el} 50/60 Hz L35 L35 kW		0.85 / 1.05	0.79 / 1	1.31 / 1.52	1.13 / 1.48	
Power consumption P _{el} 50/60 Hz L35 L50 kW		1 / 1.15	0.9 / 1.1	1.48 / 1.85	1.4 / 1.75	
Operating temperature range		+10°C...+55°C	+10°C...+55°C	+10°C...+55°C	+10°C...+55°C	
Setting range		+20°C...+55°C	+20°C...+55°C	+20°C...+55°C	+20°C...+55°C	
Energy efficiency ratio (EER) 50 Hz L35 L35 to DIN EN 14511		1.76	1.9	1.91	2.21	
Refrigerant g		R134a, 700	R134a, 700	R134a, 1175	R134a, 1175	
Permissible operating pressure (p max.) bar		28	28	30	30	
Air throughput of fans (unimpeded air flow), internal circuit/external circuit m ³ /h		600 / 1100	600 / 1100	1100 / 1100	1100 / 1100	
Weight kg		68.0	68.0	73.0	72.0	

Also required

Modular climate control concept – Section doors		see page	see page	see page	see page	113
---	--	----------	----------	----------	----------	-----

Accessories

Door-operated switch	1 pc(s).	4127.010	4127.010	4127.010	4127.010	
Master-slave cable	1 pc(s).	3124.100	3124.100	3124.100	3124.100	
Interface board	1 pc(s).	3124.200	3124.200	3124.200	3124.200	

Modular climate control concept – Section doors

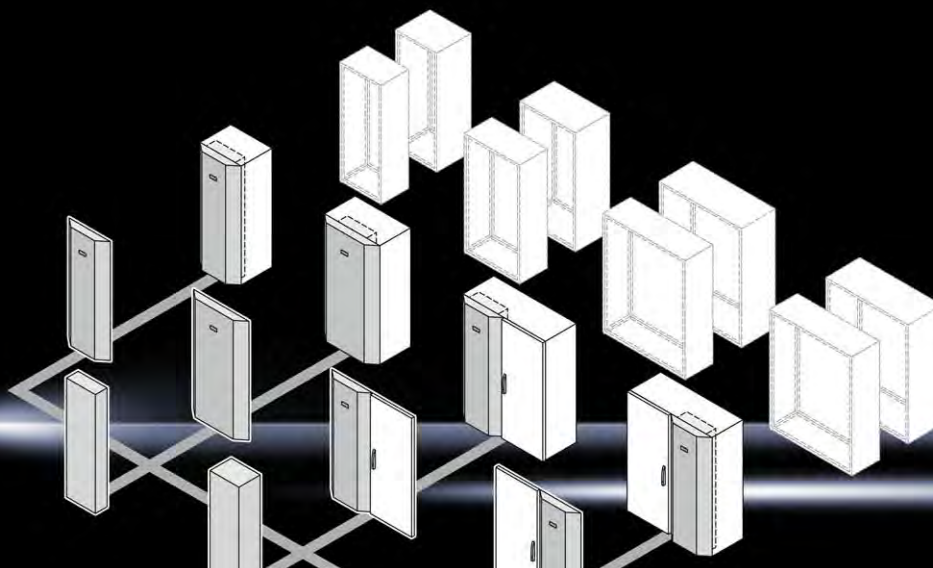

VX25 enclosures Page 54

Material:

- Sheet steel

Colour:

- RAL 7035

Supply includes:

- Section door without pre-configured cooling module
- Hinges, door opening angle approx. 130°

Note:

- The following information applies to 1200 mm wide enclosures
- For a unit positioned on the "right" or "left", the lockable door provided may be used

Approvals:

Available on the Internet

For the installation of cooling modules

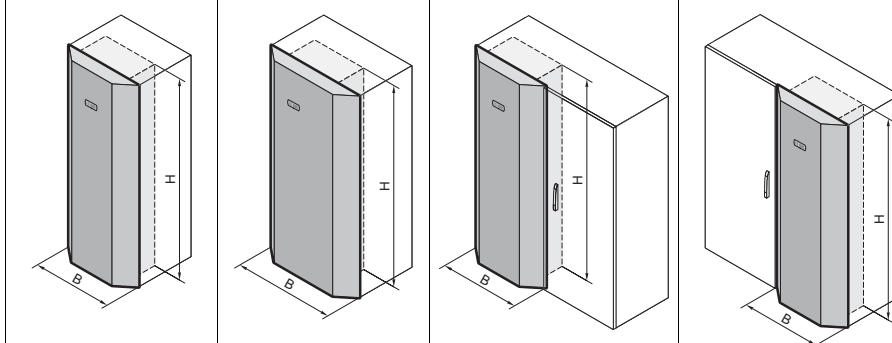

Model No.	P. of	3201.800	3201.810	3201.820	3201.830	3201.840	3201.850	3201.860	3201.870	Page
Dimensions to fit enclosure type		VX25	VX25	VX25	VX25	VX25	VX25	VX25	VX25	
with height mm		1800	2000	1800	2000	1800	2000	1800	2000	
with width mm		600	600	800	800	1200	1200	1200	1200	
Unit positioned on the left		-	-	-	-	■	■	-	-	
Unit positioned on the right		-	-	-	-	-	-	■	■	
Weight kg		24.0	27.0	34.0	35.0	25.0	28.0	48.0	57.5	

Also required

Modular climate control concept – Cooling module "Blue e"		see page	see page	see page	see page	see page	see page	see page	see page	112
---	--	----------	----------	----------	----------	----------	----------	----------	----------	-----

Accessories

Metal filter	1 pc(s).	3284.210	3284.210	3284.210	3284.210	3284.210	3284.210	3284.210	3284.210	
--------------	----------	----------	----------	----------	----------	----------	----------	----------	----------	--

Doors/locks

Installation accessories for modular front design



Modular front design

Suitable for 400 to 1200 mm wide enclosures instead of a door or rear panel. The partial doors with and without viewing panels, including cross members, may be combined with one another as required. A trim panel is required at the top and bottom in each case. The requirements for your individual front design and the considerations which must be taken into account are illustrated on the sample configuration opposite.

- 1 Front trim panel, top
- 2 Front trim panel, bottom
- 3 Partial door with viewing window
- 4 Partial door

Installation accessories for modular front design

Partial doors

The door may be optionally hinged on the right or left. The partial door is attached to the enclosure with no drilling required. In the case of partial doors without a viewing panel (height 600 – 1000 mm), the installation of a monitor frame 2305.000 is supported. Standard double-bit lock insert may be exchanged for lock inserts, type A.

Material:

- Partial door: Sheet steel, 2 mm
- Viewing window: 3 mm single-pane safety glass

Surface finish:

- Textured paint

Colour:

- RAL 7035

Supply includes:

- Cross member, hinges and lock components
- Assembly parts



Also required:

- Front trim panels, top, see page 116 or top-hinged trim panel, see page 117
- Front trim panels, bottom, see page 116



Accessories:

- Monitor frame 2305.000, see page 130
- Lock inserts, type A, see page 123
- Perforated mounting strips, see page 116

For enclosure width 400 mm

Height mm	With viewing window	P. of	Model No.
200	–	1 pc(s).	9682.142
300	–	1 pc(s).	9682.143
400	–	1 pc(s).	9682.144
600	–	1 pc(s).	9682.146
800	–	1 pc(s).	9682.148
1000	–	1 pc(s).	9682.140
1200	–	1 pc(s).	9682.152
1400	–	1 pc(s).	9682.154
1600	–	1 pc(s).	9682.156
1800	–	1 pc(s).	9682.158
2000	–	1 pc(s).	9682.150

For enclosure width 600 mm

Height mm	With viewing window	P. of	Model No.
150	–	1 pc(s).	9682.161
200	–	1 pc(s).	9682.162
300	–	1 pc(s).	9682.163
400	–	1 pc(s).	9682.164
600	–	1 pc(s).	9682.166
600	■	1 pc(s).	9682.167
800	–	1 pc(s).	9682.168
800	■	1 pc(s).	9682.169
1000	–	1 pc(s).	9682.160
1200	–	1 pc(s).	9682.172
1400	–	1 pc(s).	9682.174
1600	–	1 pc(s).	9682.176
1800	–	1 pc(s).	9682.178
2000	–	1 pc(s).	9682.170

For enclosure width 800 mm

Height mm	With viewing window	P. of	Model No.
150	–	1 pc(s).	9682.181
200	–	1 pc(s).	9682.182
300	–	1 pc(s).	9682.183
400	–	1 pc(s).	9682.184
600	–	1 pc(s).	9682.186
600	■	1 pc(s).	9682.187
800	–	1 pc(s).	9682.188
1000	–	1 pc(s).	9682.180
1200	–	1 pc(s).	9682.192
1400	–	1 pc(s).	9682.194
1600	–	1 pc(s).	9682.196
1800	–	1 pc(s).	9682.198
2000	–	1 pc(s).	9682.190

For enclosure width 1000 mm

Height mm	With viewing window	P. of	Model No.
400	–	1 pc(s).	9682.104
600	–	1 pc(s).	9682.106
800	–	1 pc(s).	9682.108

For enclosure width 1200 mm

Height mm	With viewing window	P. of	Model No.
400	–	1 pc(s).	9682.124
600	–	1 pc(s).	9682.126
800	–	1 pc(s).	9682.128



Doors/locks

Installation accessories for modular front design



Perforated mounting strips

for partial doors

For retrospective external mounting. The perforated mounting strips have a 25 mm pitch pattern of holes and may be used for mounting individual accessories such as cable ducts, hose holders etc. on the rear of the door.

Hole diameter of perforated mounting strip: 4.5 mm

Material:

- Sheet steel, 1 mm

Surface finish:

- Zinc-plated

Supply includes:

- Assembly parts

For enclosure width mm	Length mm	For partial door height mm	P. of	Model No.
400	198	150 – 800	10 pc(s).	9681.204
600	398	150 – 800	10 pc(s).	9681.206
800	598	150 – 800	10 pc(s).	9681.208



Front trim panels, top

To finish off the modular front design at the top when using partial doors. The front trim panels may be removed from the outside by unscrewing. The cross member required for mounting is included with the supply of the mounted partial door.

Material:

- Sheet steel, 2 mm

Surface finish:

- Textured paint

Colour:

- RAL 7035

Supply includes:

- Assembly parts

For enclosure width mm	Height mm	P. of	Model No.
400	100	1 pc(s).	9682.314
400	300	1 pc(s).	9682.324
600	100	1 pc(s).	9682.316
600	300	1 pc(s).	9682.326
800	100	1 pc(s).	9682.318
800	300	1 pc(s).	9682.328
1000	300	1 pc(s).	9682.320
1200	300	1 pc(s).	9682.322

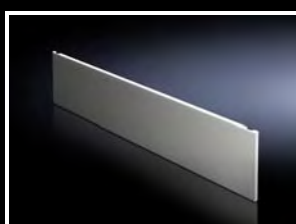

Front trim panels, bottom

To finish off the modular front design at the bottom when using partial doors. If version IP 2X is chosen, a roof plate with protection category IP 2X should be selected for top ventilation. The front trim panels may be removed from the outside by unscrewing.

Material:

- Sheet steel, 2 mm

Surface finish:

- Textured paint

Colour:

- RAL 7035

Supply includes:

- Front trim panel including cross member
- Assembly parts

Solid

For enclosure width mm	Height mm	P. of	Model No.
400	100	1 pc(s).	9682.334
400	300	1 pc(s).	9682.344
600	100	1 pc(s).	9682.336
600	300	1 pc(s).	9682.346
800	100	1 pc(s).	9682.338
800	300	1 pc(s).	9682.348
1000	100	1 pc(s).	9682.330
1000	300	1 pc(s).	9682.340
1200	100	1 pc(s).	9682.332
1200	300	1 pc(s).	9682.342

Vented

For enclosure width mm	Height mm	P. of	Model No.
400	300	1 pc(s).	9682.354
600	300	1 pc(s).	9682.356
800	300	1 pc(s).	9682.358
1000	300	1 pc(s).	9682.350
1200	300	1 pc(s).	9682.352

Also required:

Roof plate IP 2X, see page 136

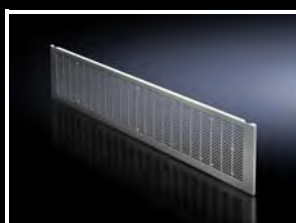

Installation accessories for modular front design

Trim panel, hinged at the top

For the installation of control and display components, in conjunction with

- Modular front design
- Protective bar

Material:

- Sheet steel, 2 mm

Surface finish:

- Textured paint

Colour:

- RAL 7035

Supply includes:

- Hinges, cam locks with double-bit insert and assembly parts

Width mm	Height mm	P. of	Model No.
600	300	1 pc(s).	8620.500
800	300	1 pc(s).	8620.501
1200	300	1 pc(s).	8620.502



Accessories:

- Stay for trim panel, hinged at the top, see page 117
- Lock inserts, type A, see page 123



Drawer

For mouse and keyboard with a maximum width of 500/700 mm. A high level of protection is retained, even with the flap open.

Material:

- Sheet steel

Colour:

- RAL 7035

Height mm	Width mm	Model No.
200	600	8620.520
200	800	8620.521

Supply includes:

- Flap and assembly parts
- Cross member



Accessories:

- Lock inserts, 27 mm, type A, see page 123



Support stay

for trim panel, hinged at the top

5 pitch pattern positions up to a maximum opening angle of approx. 85°.

Material:

- Sheet steel

Surface finish:

- Zinc-plated

P. of	Model No.
2 pc(s).	8801.260



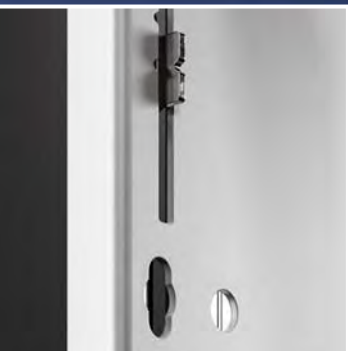
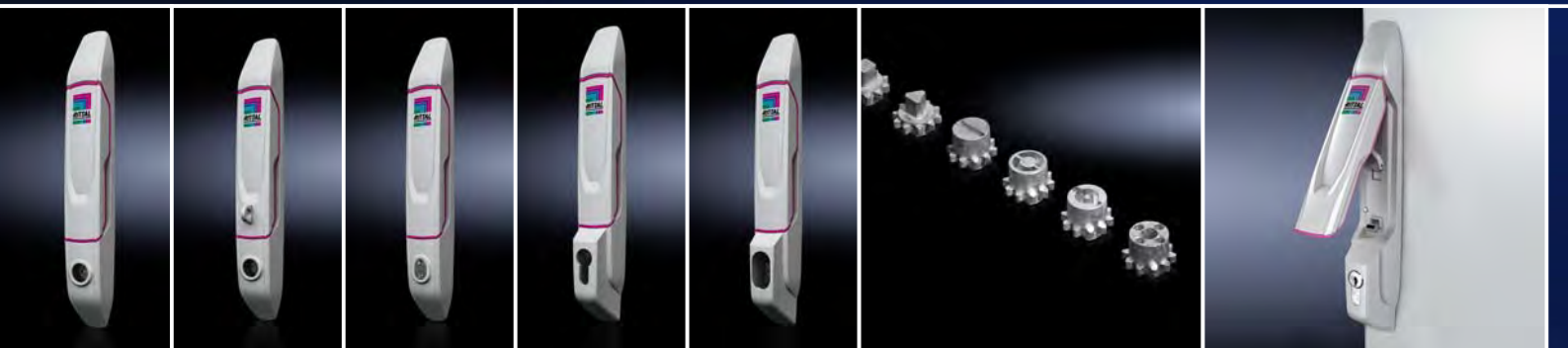

Electronic lock systems
When using electronic lock systems that require additional cabling, punchings are provided as standard in the door so that they can be fitted retrospectively without the need for machining.



Multiple lock
Up to six padlocks may be attached to the multiple lock, providing individual access rights for different individuals or groups of individuals.



Standard lock

The standard lock allows convenient, tool-free installation and removal. Simply unlatch the locking pin with the door opened. Replacing the lock insert or exchanging it for a comfort handle couldn't be simpler.

Comfort handle

Installation of the comfort handle is completely tool-free, and with its ingenious fold-down system, it does not require any swing space or door surface area. The comfort handle is available in all standard versions and lock inserts.

Seamless lock system

Because a full range of standard lock inserts is available for all the locks used, a seamless lock system can be created.



Doors/locks

Lock system



Comfort handle VX

As the handle does not take up any swing space, due to its folding action, the door surface area available for installed equipment is maximised. Simple assembly, thanks to the snap-mounted handle system.

					
	For lock inserts	For padlock and lock inserts	With lock insert, lock E1 ¹⁾	For semi-cylinder	Prepared for ASSA lock system
	Model No.				
Die-cast zinc RAL 7035	8618.200	8618.230	8618.240	8618.250	8618.270
Precision-cast stainless steel	8618.220	-	-	8618.280	-
Lock inserts, type G					
7 mm square	8618.300	8618.300	-	-	-
8 mm square	8618.301	8618.301	-	-	-
7 mm triangular	8618.302	8618.302	-	-	-
8 mm triangular	8618.303	8618.303	-	-	-
Screwdriver	8618.304	8618.304	-	-	-
Daimler insert	8618.305	8618.305	-	-	-
3 mm double-bit	8618.306	8618.306	-	-	-
Fiat	8618.307	8618.307	-	-	-
6.5 mm triangular (CNOMO)	8618.308	8618.308	-	-	-
Lock and push-button inserts					
Lock insert, lock no. 3524 E ²⁾	8611.180	8611.180	-	2467.000	-
Push-button insert	8611.190	8611.190	-	2468.000	-
Push-button and lock insert ²⁾	8611.200 ³⁾	8611.200 ³⁾	-	2469.000 ⁴⁾	-
Semi-cylinder					
To DIN 18 252 ⁵⁾	-	-	-	9785.040	-
	-	-	-	9785.042 ⁶⁾	-

¹⁾ Only for use with VW, Audi, SEAT, SkodaAuto, supplied without key

²⁾ With 2 keys

³⁾ Lock no. 12321, no other lock is possible

⁴⁾ Lock no. 2123, no other lock is possible

⁵⁾ With 3 keys for each lock insert

⁶⁾ Packs of two, simultaneous locking within the same pack, no simultaneous locking for different packs



Locking bar latch to CNOMO¹⁾

To fit all locking bars in doors and glazed doors with standard lock or comfort handle VX

The latch prevents the locking bars from moving when the door is open.

¹⁾ CNOMO is a French automobile industry standard. For safety reasons, it must not be possible to lock the handle whilst the door is open.

P. of	Model No.
10 pc(s).	8618.460



Also required:

- for CNOMO¹⁾ lock inserts, type G, 6.5 mm triangular insert 8618.308, see page 121



Lock insert

for installation in comfort handle VX,
Ergoform-S standard

Installation in			
	Lock and push-button inserts		Semi-cylinder
	Comfort handle ⁶⁾	Comfort handle ⁷⁾ , Ergoform-S standard	Comfort handle ⁷⁾ , Ergoform-S standard
Model No.			
Lock insert, lock no. 3524 E ¹⁾	8611.180	2467.000	-
Push-button insert	8611.190	2468.000	-
Push-button and lock insert ¹⁾	8611.200²⁾	2469.000³⁾	-
To DIN 18 252 ⁴⁾	-	-	9785.040
	-	-	9785.042⁵⁾

¹⁾ With two keys

²⁾ Lock no. 12321; no other lock is possible

³⁾ Lock no. 2123; no other lock is possible

⁴⁾ With 3 keys for each lock insert

⁵⁾ Packs of two, simultaneous locking within the same pack, no simultaneous locking for different packs

⁶⁾ For lock inserts

⁷⁾ For semi-cylinders



Lock insert

Type		G
		
Material	P. of	Die-cast zinc
Model No.		
7 mm square	1 pc(s).	8618.300
8 mm square	1 pc(s).	8618.301
7 mm triangular	1 pc(s).	8618.302
8 mm triangular	1 pc(s).	8618.303
Screwdriver	1 pc(s).	8618.304
Daimler insert	1 pc(s).	8618.305
3 mm double-bit	1 pc(s).	8618.306
Fiat	1 pc(s).	8618.307
6.5 mm triangular (CNOMO)	1 pc(s).	8618.308



Doors/locks

Lock system

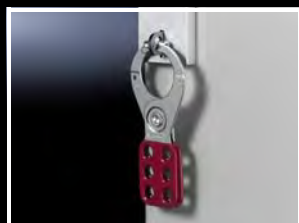

Multiple lock

for 6 padlocks

The ideal solution in cases where several people need individual access for maintenance and repair purposes.

Material:

- Sheet steel

Surface finish:

- Zinc-plated

P. of	Model No.
2 pc(s).	2493.500



Safety lock

Fitted to doors, to protect against contact with live electrical equipment whilst the master switch is ON.

Function:

- Locks the door when the master switch is ON.
- Mains power (voltage) is only enabled whilst the door is closed.
- Monitoring of the lock magnet via an additional closing contact.

Supply includes:

- Lock
- Actuator
- Angle bracket
- Assembly parts

Connection voltage for lock magnet	Model No.
230 V AC 11 VA	2416.000
24 V DC 8 W	2418.000
120 V AC 8 VA	2419.000







Also required:

- For two-door enclosures (for the overlapping door, to indicate "enclosure door closed"): Door-operated switch 4127.010



Enclosure key

				
	Model No.			
	-	-	2549.000	2549.500²⁾
Double-bit no. 5	2531.000	-	■	■
Security lock no. 3524 E	-	2532.000¹⁾	-	-
7 mm triangular	2545.000	-	-	■
8 mm triangular	2546.000	-	■	■
7 mm square	2547.000	-	-	■
8 mm square	2548.000	-	■	■
for Daimler	2521.000	-	-	-
for Fiat	2308.000	-	-	-

¹⁾ Packs of 2

²⁾ With bit adaptor and reversible bit

Ergoform-S lock system

For swing frame, large, with trim panel and system window. The unlocked handle folds out forwards, and the lock is opened by swivelling.



Material:

– Die-cast zinc

Surface finish:

– Powder-coated



		
	Standard	Special with security lock insert E1 ¹⁾
	Model No.	
RAL 7035 with brown handle	–	2456.500
RAL 7035	2435.000	–
Lock inserts, type A		
7 mm square	2460.000	–
8 mm square	2461.000	–
7 mm triangular	2462.000	–
8 mm triangular	2463.000	–
Screwdriver	2464.000	–
Daimler insert	2465.000	–
3 mm double-bit	2466.000	–
Fiat	2307.000	–
6.5 mm triangular (CNOMO)	2460.650	–
Lock and push-button inserts		
Lock insert, lock no. 3524 E ²⁾	2467.000	–
Push-button insert	2468.000	–
Push-button and lock insert ²⁾	2469.000 ³⁾	–
Semi-cylinder		
To DIN 18 252 ⁴⁾	9785.040	–
	9785.042 ⁵⁾	–

¹⁾ Only for use with VW, Audi, SEAT, SkodaAuto, supplied without key

²⁾ With two keys

³⁾ Lock no. 2123; no other lock is possible

⁴⁾ With 3 keys for each lock insert

⁵⁾ Packs of two, simultaneous locking within the same pack, no simultaneous locking for different packs



Punched section with mounting flange, 14 x 39 mm
The punched section with mounting flange, 14 x 39 mm, allows completely flexible door installation on the tubular door frame, no machining required.



Spacers
Spacers allow you to achieve a mounting level at a distance, on which a top hat rail or contact hazard protection cover plate can easily be fitted, for installed equipment in the door.



Ride-up roller
Even the heaviest populated door is easily opened and closed with the ride-up roller.



Door stay
The door stay for escape routes guarantees convenience and safety. The enclosure door is securely locked into position for assembly work. In dangerous situations, the stay is actuated automatically under pressure, and if 180° hinges are used, the escape route is clear in both directions.

Wiring plan lectern

During maintenance work, the wiring plan lectern folds out easily to hold circuit diagrams and documents. The integral punchings provide temporary accommodation for tools.

Partial mounting plate

With partial mounting plates, even preconfigured assemblies are readily fitted to the tubular door frame.

Tubular door frame

The all-round T-head punchings allow simple, fast attachment of cables with commercially available cable ties.



Doors/locks

Door, internal

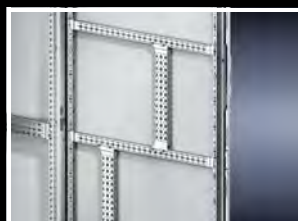

Punched section with mounting flange, 14 x 39 mm

Secure location and fast mounting on the tubular door frame.

For the attachment of

- Cable ducts
- Cable conduit holders
- Equipment installed on the door, etc.

Material:

- Sheet steel

Surface finish:

- Zinc-plated

Supply includes:

- Assembly parts

For door width mm	P. of	Model No.
400	4 pc(s).	8619.700
500	4 pc(s).	8619.710
600	4 pc(s).	8619.720
800	4 pc(s).	8619.730
900	4 pc(s).	8619.740
1000	4 pc(s).	8619.750

+ Accessories:

- Screws and self-tapping screws M5 for configuring the customer's own components on the punched section with mounting flange, see page 158

Spacer

The universal assembly component for all situations where a distance from the mounting level is required. With self-tapping thread for 4.5 mm diameter holes. The following components may be attached to the rear using 5.5 x 13 mm screws:

- Top-hat / cross rails
- Contact hazard protection covers
- Master switch trim panels
- Cable clamp rails
- etc.

Material:

- Hexagonal steel (SW8)

Surface finish:

- Zinc-plated

+ Accessories:

- Screws 5.5 x 13 mm, see page 158

Length mm	P. of	Model No.
25	12 pc(s).	2311.225
50	12 pc(s).	2311.250

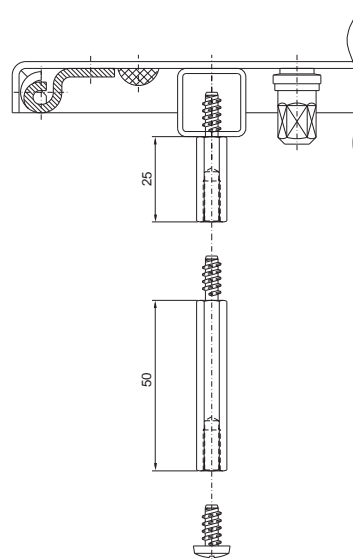

Utility lectern

For programming units etc., prepared for mounting on the tubular door frame or on any sufficiently large surface. When required for servicing, it folds out quickly with a maximum support area, and after use is lowered between the tubular door frames in a space-saving design.

Load capacity:

- Max. 300 N

Material:

- Sheet steel

Colour:

- RAL 7035

Support area		For door width mm	Model No.
Width mm	Depth mm		
413	400	600	4638.600
613	400	800	4638.800

Wiring plan lectern

Holds wiring plans during fault-finding and maintenance work. Wiring plan lecterns may be bayed according to the door width. For mounting on the tubular door frame.

Material:

- Utility lectern: Polypropylene
- Mounting bracket: Die-cast zinc

Colour:

- Similar to RAL 7035

Supply includes:

- Wiring plan lectern (width 210 mm)
- Assembly parts

For door width mm	Required/possible no. of wiring plan lecterns	
	min.	max.
400	1	1
500	1	1
600	2	2
800	2	3
1000	3	3

P. of	Model No.
1 pc(s).	4120.000



Storage box

For fixing to all flat, clean surfaces with double-sided adhesive tape. Secure storage of CDs/DVDs, small parts such as fuses etc.

Capacity:

- Max. 10 CDs/DVDs

Material:

- Polyamide

P. of	Model No.
1 pc(s).	2446.000

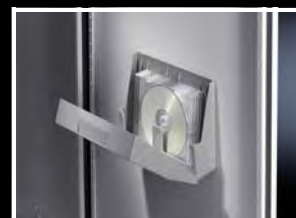

Wiring plan pocket, sheet steel

For fastening to tubular door frames at any height.

Colour:

- RAL 7035

Supply includes:

- Assembly parts

D = 90 mm

To fit door width mm	Clearance opening mm		Model No.
	W	H	
400	255	210	4114.000
500	355	210	4115.000
600	455	210	4116.000
800	655	210	4118.000
900	755	210	4123.000
1000	855	210	4124.000



D = 35 mm

To fit door width mm	Clearance opening mm		Model No.
	W	H	
500	355	210	4115.500
600	455	210	4116.500
800	655	210	4118.500



Wiring plan pocket, plastic

For adhering to surfaces.

Material:

- Polystyrene with self-adhesive fastening strips

Colour:

- Similar to RAL 7035

For format	Clearance opening mm			Model No.
	W	H	D	
A3 landscape	438	286	45	2513.000
A4 portrait	228	254	17	2514.000
A5 landscape	228	174	17	2515.000



Doors/locks

Door, internal



Wiring plan pocket with transparent pouch

With welded-on transparent pouch and self-adhesive backing.

For format	Model No.
A4	2510.000
A3	2512.000



Door stay for escape routes

The stay is actuated automatically in the event of pressure, releasing the door in both directions. In conjunction with 180° hinges, this ensures that no escape routes are blocked by open doors in the event of an emergency. The space-saving design does not obstruct the installed equipment in the door.

P. of	Model No.
1 pc(s).	8618.400

+ Accessories:

- 180° hinge, see page 111

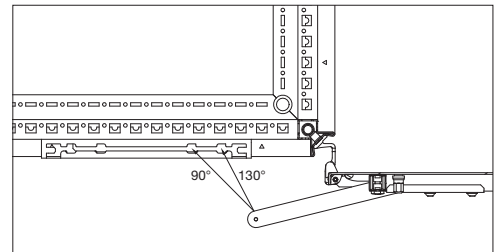

Ride-up roller for door

Lifts up the door when there is heavy installed equipment (e.g. cooling unit) as a closing aid. For attaching to the tubular door frame.

P. of	Model No.
10 pc(s).	8618.420



Transport and mounting handle

For safe installation and removal of the door and during relocation in the workshop.

P. of	Model No.
1 pc(s).	2415.100

System window

To cover display and operating elements or cut-outs, and to protect against dirt and liquids as well as unauthorised access.

Consisting of the following 2 components:

1. Base frame:

- Easily screw-fastened to the door, thanks to modified dimensions (tubular door frame may be used as a drilling template)
- Readily height-adjustable
- Stabilises the door cut-out
- Conceals the cut edge
- The rain canopy
 - prevents dirt from landing on the seal
 - protects the glass from being lifted out
 - prevents the ingress of dirt, and prevents moisture from running behind the window when opened
- Frame section height 30 mm or 60 mm

2. Viewing window:

- Made from single-pane safety glass:
 - High level of resistance to solvents and scratches
 - Anti-static
 - Reduced risk of injury if broken
- Cam lock with double-bit insert, may be exchanged for lock inserts, type A, and semi-cylinders in the Ergoform-S lock system (not for 2735.500 and .560)
- Hinge with 180° opening angle, easily inserted

Material:

- Extruded aluminium sections with die-cast zinc corner pieces and single-pane safety glass

Surface finish:

- Base frame: Powder-coated in RAL 7035
- Hinge and lock section: Natural-anodised

Protection category IP to IEC 60 529:

- IP 54

30 section

To fit enclosure width mm	Window dimensions, external mm		Model No.
	B	H	
600	500	270	2735.500
		370	2735.510
		470	2735.520
		570	2735.530
800	700	670	2735.540
		270	2735.560
		370	2735.570
		470	2735.580
		570	2735.590
		670	2735.250

60 section

To fit enclosure width mm	Window dimensions, external mm		Model No.
	B	H	
600	500	370	2736.510
		470	2736.520
		570	2736.530
		670	2736.540
800	700	670	2736.500



B = width

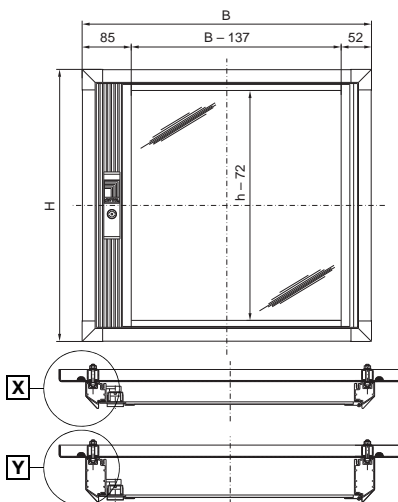

Viewing area (B - 137) offset by 16.5 mm towards the hinge side

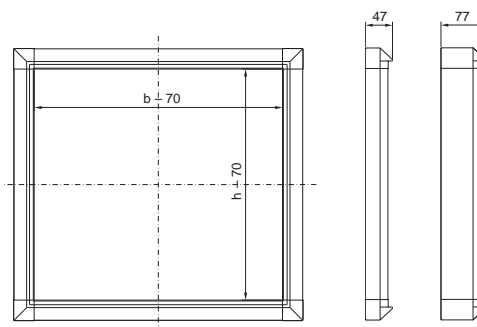

View X for section height 30

View Y for section height 60

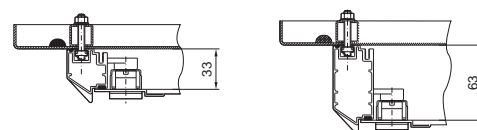

Doors/locks

Viewing window



Viewing window

Stainless steel

Fitted as standard with internal 130° hinges and all-round seal. The double-bit lock insert may be exchanged for 27 mm lock inserts, type A.

Material:

- Stainless steel 1.4301 (AISI 304)
- Single-pane safety glass

Protection category IP to IEC 60 529:

- IP 54

Supply includes:

- Assembly parts

Width mm	Height mm	Depth mm	Model No.
522	600	38	2793.560



Accessories:

- Lock inserts 27 mm, type A, see page 123

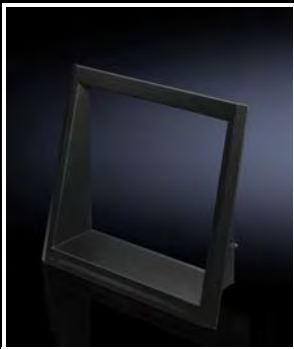
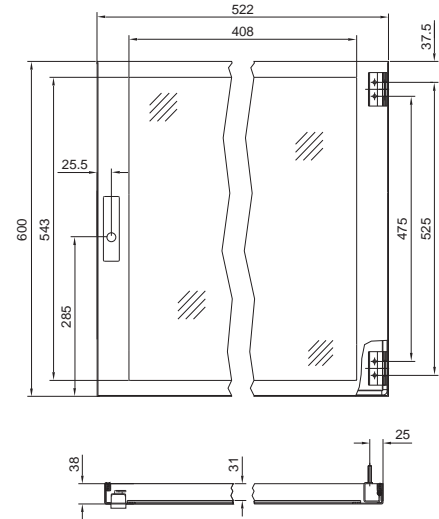

Monitor frame

for door width 600 and 800 mm

For covering a door cut-out, for all standard monitors up to 482.6 mm (19").

Protection category IP to IEC 60 529:

- IP 54

Supply includes:

- Safety glass panel

Dimensions	Width mm	Height mm	Model No.
External dimensions	470	430	2305.000
Viewing area	375	325	
Cut-out required	415	375	



Identification strip

For individual field identifiers on the door, including transparent cover and assembly parts.

For labels:

Width: Enclosure width - 150 mm
Height: 29 mm
Thickness: 0.75 mm

Colour:

- RAL 7035

For enclosure width mm	Model No.
600	8618.450
800	8618.451

Keyboards, supports and drawers

Fold-out tray

for keyboard and mouse

For installation in

- 600 and 800 mm wide doors
- 482.6 mm (19") swing frames and enclosures

Standard double-bit lock insert may be exchanged for lock inserts 27 mm, type A, and for lock cylinder 2571.000.

Material:

- Cover: Sheet steel
- Side parts: Cast aluminium
- Tray: Extruded aluminium section

Surface finish:

- Cover, side parts: Textured paint
- Tray: Natural anodised

Colour:

- Cover, side parts: RAL 7035

Protection category:

- IP 55 to IEC 60 529
- NEMA 12



Accessories:

- Mousepad support, pull-out, see page 131

Mounting cut-out

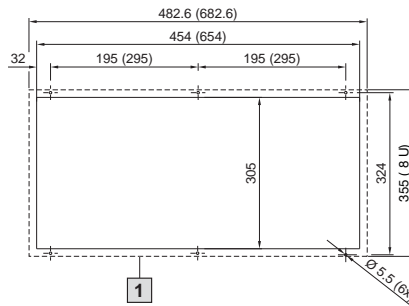

1 Support surface

For door width mm	External dimensions W x H x D mm	Installation depth mm	Max. keyboard dimensions W x H x D mm	Model No.
600	482.6 (19") x 355 (8 U) x 126	93	405 x 50 x 250 405 x 50 x 195 ¹⁾	2379.600
800	682.6 x 355 (8 U) x 126	93	605 x 50 x 250 605 x 50 x 195 ¹⁾ 475 ¹⁾ x 50 x 250	2379.800

¹⁾ Maximum keyboard size with holder for mouse

Support for mousepad, pull-out with mouse holder

For screw-fastening into the fold-out tray 2379.600/2379.800, see page 131. To fit all standard mousepads up to 250 x 205 mm.

Colour:

- RAL 7035

Supply includes:

- Assembly parts

P. of	Model No.
1 pc(s).	2379.900





Eyebolts

For transporting by crane, the standard roof attachment screw is easily exchanged for eyebolts, or in the case of bayed enclosure suites, combined with the combination angle. With both variants, the automatic potential equalisation is retained.



Spacer

Spacers are available in three different heights, so that the roof can easily be raised for ventilation purposes.



Dust guard trim

The dust guard trim prevents dust from depositing on the upper edge of the door and in the gap between the door and the horizontal enclosure section. The integral transparent plastic is a simple way of adding individual labelling or branding to the enclosure module.



Wall bracket

For enclosures with a shallow depth or heavy equipment in the door or swing frame, the wall brackets provide stability.



Pressure stopper

The pressure stopper allows retrospective fitting of a pressure relief function to comply with health and safety regulations for arc-proofing to IEC/TR 61 641.



Punched section with mounting flange

Standard punched sections may also be used to support the roof and side panels. This simplifies engineering and assembly, and relieves pressure on the parts warehouse.



Top-mounting module

The top-mounting module quickly and easily creates 200 mm extra space in the height for busbar systems across enclosures, or for a cable chamber in the roof space. The base/plinth system VX can also be used for simple cable routing and panelling.



Roof



Dust guard trim

To protect against dust deposits on the upper edge of the door and between the door and upper horizontal enclosure section. The dust guard trim provides space for texts or company logos.

Colour:
– RAL 7035

Supply includes:
– Clear plastic strip for text labels (height 29.5 mm)

Length mm	P. of	Model No.
600	1 pc(s).	2424.100
800	1 pc(s).	2425.100
1000	1 pc(s).	2427.100
1200	1 pc(s).	2426.100

Note:
– Also suitable for use in conjunction with top baying cover, see page 107



Top-mounting module

As a cable chamber for cable infeed from above, or for power distribution with busbar systems across bayed enclosures. The cover plate supplied as standard is used to finish off at the top. The enclosure height is increased by 200 mm with the top-mounting module fitted. Installation accessories for top and bottom, see diagram and explanations below.

Material:
– Sheet steel, 1.5 mm

Surface finish:
– Spray-finished, textured paint

Colour:
– RAL 7035

Protection category IP to IEC 60 529:
– IP 55

NEMA protection category:
– NEMA 12

For enclosures		P. of	Model No.
Width (B) mm	Depth mm		
600	600	1 pc(s).	8618.500
800	600	1 pc(s).	8618.510
1000	600	1 pc(s).	8618.520
1200	600	1 pc(s).	8618.530

Supply includes:
– 1 frame module
– 2 trim panels (front and rear)
– 8 retainers with automatic potential equalisation
– Assembly parts

! Also required:

– Side panel for top-mounting module 8618.540, see page 135

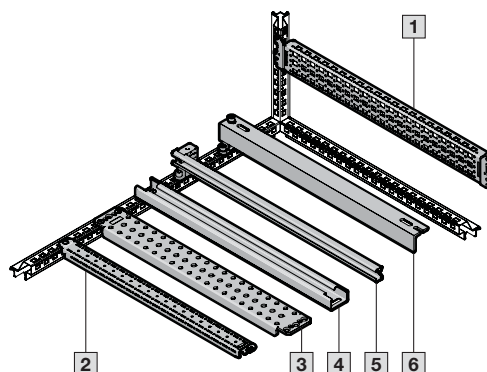
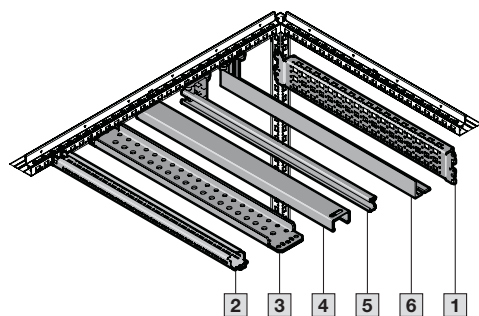
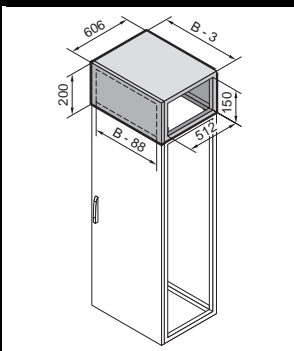

+ Accessories:

Description	Page
1 Punched section with mounting flange 23 x 64 mm (for the inner level)	150
2 Punched rail 18 x 39 mm	151
3 Support rail 75 x 20 mm	153
4 Support rail 48 x 26 mm	152
5 C rail 30/15	152
6 Cable clamp rail	187

Side panel

for top-mounting module

To finish off the side of a top-mounting module or bayed suite.

Material:

- Sheet steel, 1.5 mm

Surface finish:

- Spray-finished, textured paint

Colour:

- RAL 7035

Supply includes:

- Assembly parts

P. of	Model No.
2 pc(s).	8618.540



Roof mounting screw

Thread: M12

Material:

- Steel

Surface finish:

- Zinc-plated

Supply includes:

- 20 panhead screws M 12 x 20
- 20 serrated sealing washers A 12.5

P. of	Model No.
20 pc(s).	4198.000



Spacer

for roof plate

To raise the roof for ventilation purposes, in three different heights.

Thread: M12

Material:

- Hexagonal sectional steel

Surface finish:

- Zinc-plated

Supply includes:

- Assembly parts

Height mm	P. of	Model No.
10	4 pc(s).	2422.000
20	4 pc(s).	2423.000
50	4 pc(s).	7967.000



Eyebolts

For transporting enclosures by crane.

Thread: M12

Supply includes:

- 4 eyebolts M12
- 4 serrated sealing washers A 12.5

Material	P. of	Model No.
Steel, zinc-plated, C 15E	4 pc(s).	4568.000
Stainless steel 1.4301 (AISI 304)	4 pc(s).	4568.500



Roof



Wall bracket

For attaching enclosures with a shallow depth and e.g. heavy components on the door or a built-in swing frame, to a wall at the top.

Material:

– Sheet steel

Surface finish:

– Zinc-plated

P. of	Model No.
4 pc(s)	4595.000

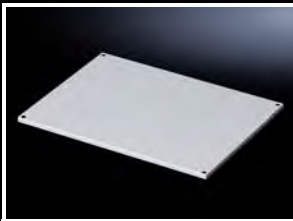

Roof plate

For enclosures without roof plate and in exchange for the standard roof.

Material:

– Sheet steel, 1.5 mm

Surface finish:

– Textured paint

Colour:

– RAL 7035

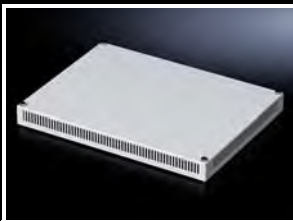

IP 55, solid

For enclosures		P. of	Model No.
Width mm	Depth mm		
400	600	1 pc(s).	9681.646
600	600	1 pc(s).	9681.666
800	600	1 pc(s).	9681.686
1000	600	1 pc(s).	9681.606
400	800	1 pc(s).	9681.648
600	800	1 pc(s).	9681.668
800	800	1 pc(s).	9681.688
1000	800	1 pc(s).	9681.608

For cable entry glands

For enclosures		Required no. of glands	P. of	Model No.
Width mm	Depth mm			
600	400	2 pc(s).	1 pc(s).	9681.564
850	400	3 pc(s).	1 pc(s).	9681.594
1100	400	4 pc(s).	1 pc(s).	9681.514
400	600	3 pc(s).	1 pc(s).	9681.546
600	600	4 pc(s).	1 pc(s).	9681.566
800	600	8 pc(s).	1 pc(s).	9681.586
850	600	6 pc(s).	1 pc(s).	9681.596
1100	600	8 pc(s).	1 pc(s).	9681.516
400	800	4 pc(s).	1 pc(s).	9681.548
600	800	8 pc(s).	1 pc(s).	9681.568
800	800	8 pc(s).	1 pc(s).	9681.588

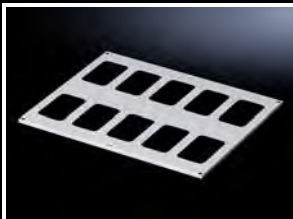

IP 2X with ventilation hole, build height: 72 mm, supply includes: Assembly parts

For enclosures		P. of	Model No.
Width mm	Depth mm		
400	600	1 pc(s).	9681.846
600	600	1 pc(s).	9681.866
800	600	1 pc(s).	9681.886
1000	600	1 pc(s).	9681.806
1200	600	1 pc(s).	9681.826
400	800	1 pc(s).	9681.848
600	800	1 pc(s).	9681.868
800	800	1 pc(s).	9681.888
1000	800	1 pc(s).	9681.808
1200	800	1 pc(s).	9681.828

Also required:

Cable entry gland, see page 137

Pressure stoppers

for roof plate

For converting the IP 55 roof plate into a roof plate with pressure relief function. The pressure relief function is essential for compliance with health and safety regulations for arc-proofing to IEC/TR 61641.

Material:

- Polyamide (PA 6.6)

Supply includes:

- 2 warning stickers

P. of	Model No.
4 pc(s).	9674.790

Note:

- 2 pressure stoppers and 1 warning sticker are required for one roof plate
- The arc-proofing compliance limits are dependent on the busbar system used



Cable entry gland

- Including seal
- External dimensions 250 x 160 mm
- Protection category IP 55
- Colour RAL 7035

Type	Material	P. of	Model No.
1 14 x M25/32	Insulating material	1 pc(s).	9665.750
2 2 x M25/32/40, 1 x M32/40/50, 2 x M40/50/63	Insulating material	1 pc(s).	9665.760
3 With sealing membranes 32 x Ø 7 – 16 mm, 4 x Ø 10 – 20 mm, 3 x Ø 14 – 26 mm	Insulating material	1 pc(s).	9665.770
4 With entry fittings up to Ø 66 mm	Insulating material	1 pc(s).	9665.780
5 Solid	Sheet steel, spray-finished	4 pc(s).	9665.785

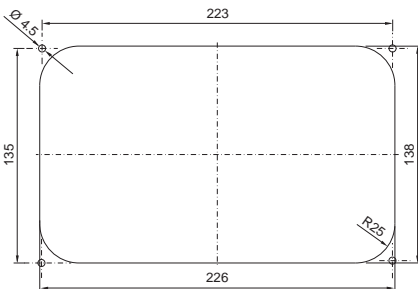
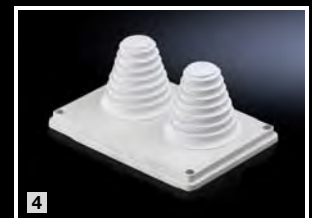
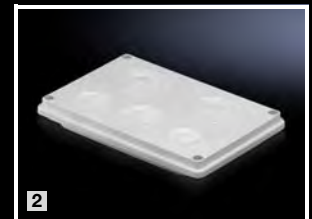

Cut-out dimensions for 9665.750 to 9665.785

Mounting plates



Earthing

The keyhole opening allows simple retrospective earthing of the mounting plate from the front while in an installed state, without having to hold a screw or nut behind the mounting plate.



Transportation

For transportation purposes, or with high dynamic loads, the mounting plate can easily be additionally secured at the top and bottom with a screw attachment.



Installation options

The mounting plate may be installed in the enclosure from all sides. Up to three mounting plates may be installed simultaneously in one enclosure; back-to-back mounting is also supported. For example, this allows an enclosure with a door instead of a rear panel to be populated from the front and rear in a space-saving solution.



Depth adjustment

The mounting plate supports straightforward depth adjustment on a 25 pitch pattern using slide blocks and the patented mounting plate attachment at the top. Using a special installation kit, the mounting plate may be offset by a further 20 mm in the depth, and populated mounting plates may also be installed from the rear.

System divider

Divides the enclosure width into two zones. For example, this allows mounting plates, cable clamp rails or swing frames from 600 mm wide enclosures to be fitted in 1200 mm wide enclosures.

Mounting surface

In the rearmost installation position, the mounting plate forms a continuous installation space with the enclosure frame. In a set forward position, a separate mounting plate infill performs this role.

Partial mounting plates

The partial mounting plates quickly and flexibly create additional mounting surfaces at all enclosure levels. They may be used as a component shelf, and can also be hinged to retain access to the mounting level behind. They may even be used on the tubular door frame. The keyhole attachment ensures extremely fast, safe assembly by simply locating into position and securing.



Interior installation

Mounting plates



Mounting positions

The mounting plate included with the supply, together with the

- Mounting plate infills
- Partial mounting plates
- etc.

available as accessories, lend themselves to extremely flexible use inside the enclosure, enabling you to achieve the ideal mounting position for every application.

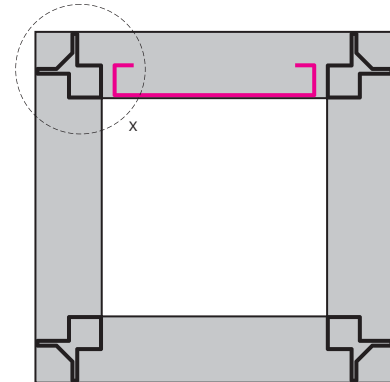

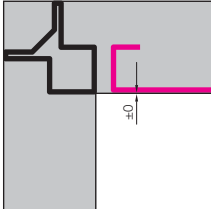
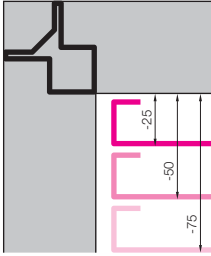
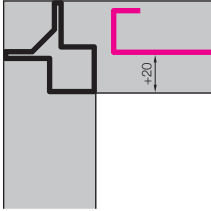
Detail X	Mounting position Mounting plate	Function	Benefits
	Flush with the enclosure frame Position: ±0 mm	Included for enclosures with mounting plate.	The mounting plate and enclosure frame create a continuous mounting surface at the same depth. Simple top-mounting of the enclosure frame is supported, and can be used for continuous enclosure-to-enclosure cable trunking, support rails etc. The usable mounting width is enlarged by up to 25%, depending on the enclosure selection.
	Set forward from the enclosure frame on a 25 mm pitch pattern Position: -25 mm -50 mm -75 mm etc.	Included for enclosures with mounting plate.	Creates space behind the mounting plate for the installation of components or for cable routing. Ideal for moving the centre of gravity of installed equipment closer to the centre of the enclosure, or when a short distance from the door is required, e.g. in order to fit a master switch. The distance between the mounting plate and the door is reduced on a 25 mm pitch pattern compared with the flush mounting position.
	Set back behind the enclosure frame Position: +20 mm	Via multi-functional installation kit for mounting plate 8617.370, see page 144	For maximising the installation depth in the enclosure. Particularly useful in situations where deep installations in a single enclosure, such as frequency converters, would increase the depth for the entire bayed enclosure suite. The installation depth in the enclosure is increased by 20 mm compared with the flush mounting position.

Interior installation

Mounting plates

Mounting plate infill

For a continuous mounting surface in bayed suites where the mounting plate is set forward.

Material:

- Sheet steel, 2 mm

Surface finish:

- Zinc-plated

Supply includes:

- Assembly parts

For enclosure height mm	P. of	Model No.
1800	1 pc(s).	4590.700
2000	1 pc(s).	4591.700
2200	1 pc(s).	4592.700



Detail	Mounting position of mounting plate	Benefits
	<p>Set forward from the enclosure frame on a 25 mm pitch pattern</p> <p>Position: -25 mm -50 mm -75 mm etc.</p>	<p>The usable mounting width is enlarged by up to 25%, depending on the enclosure selection.</p>

Mounting plate attachment

Type A

To reduce vibrations in the mounting plate, e.g. in dynamic applications and when transporting with heavy assemblies. Simple mounting directly on the enclosure frame. During installation, the mounting plate latches automatically into the mounting plate attachment. The mounting plate attachment type A keeps the front of the mounting plate completely free for unrestricted use. Populated mounting plates may be mounted from the front without dismantling the rear panel.

P. of	Model No.
10 pc(s).	8617.350

Material:

- Spring steel

Supply includes:

- Safety clip
- Assembly parts

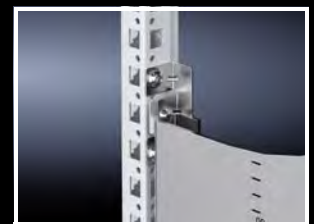

Detail	Mounting position of mounting plate	Installation option	Attachment to the mounting plate
	<p>Flush with the enclosure frame</p> <p>Position: ±0 mm</p>	<p>2 pc(s). per enclosure/ mounting plate, at the side, half-way up the mounting plate</p>	<p>Latched home</p>

Interior installation

Mounting plates

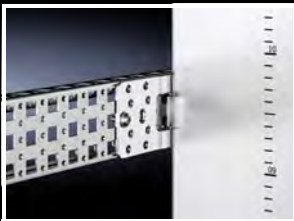

Mounting plate attachment

Type B

To reduce vibrations in the mounting plate, e.g. in dynamic applications and when transporting with heavy assemblies. Simple mounting directly on the enclosure frame or on the punched section with mounting flange 23 x 64 mm. The mounting plate may optionally be screw-fastened with the mounting plate attachment, or form-fit connected.

Depending on the installation situation, the mounting plate attachment type B either minimally surrounds the mounting plate, or keeps the front of the mounting plate completely free for unrestricted use. May be mounted from the front or the rear, depending on the situation.

P. of	Model No.
10 pc(s).	8617.351

Material:

- Sheet steel

Surface finish:

- Zinc-plated, passivated

Supply includes:

- Assembly parts



Accessories:

- Punched section with mounting flange 23 x 64 mm for the inner level, see page 150

Detail	Mounting position of mounting plate	Installation option	Attachment to the mounting plate
	Set forward from the enclosure frame Position: -50 mm	1 2 pc(s). per enclosure/mounting plate, at the side, half-way up the mounting plate	Screw-fastened
	Set forward from the enclosure frame Position: -50 mm	2 All-round between the enclosure and mounting plate in any quantity	Connected
	Set forward from the enclosure frame Position: -75 mm	1 2 pc(s). per enclosure/mounting plate, at the side, half-way up the mounting plate	Screw-fastened
	Set forward from the enclosure frame Position: -75 mm	2 All-round between the enclosure and mounting plate in any quantity	Connected
	Set forward from the enclosure frame 1 Position: -100 mm or larger	All-round between the enclosure and mounting plate in any quantity. One punched section with mounting flange 23 x 64 mm to match the enclosure depth is required for each mounting plate attachment.	Connected
	2 Position: -25 mm or larger		

Interior installation

Mounting plates

Mounting plate attachment

Type C

To reduce vibrations in the mounting plate, e.g. in dynamic applications and when transporting with heavy assemblies. Simple mounting directly on the enclosure frame. The mounting plate may be form-fit connected and clamped with the mounting plate attachment. The mounting plate attachment type C keeps the front of the mounting plate completely free for unrestricted use. With the mounting plate installed and the rear panel dismantled, it can be fitted from the rear.

P. of	Model No.
10 pc(s).	8617.352

Material:

- Sheet steel

Surface finish:

- Zinc-plated, passivated

Supply includes:

- Assembly parts

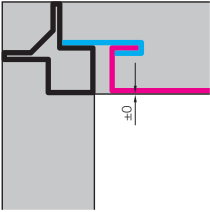
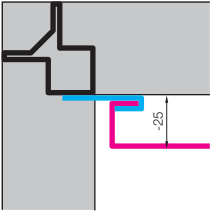
Detail	Mounting position of mounting plate	Installation option	Attachment to the mounting plate
	Flush with the enclosure frame Position: ±0 mm	All-round between the enclosure and mounting plate in any quantity	Connected, clamped
	Set forward from the enclosure frame Position: -25 mm	All-round between the enclosure and mounting plate in any quantity	Inserted, clamped

Installation kit

for back-to-back mounting plates

The minimum spacing between the mounting plates facilitates maximum assemblies on both mounting plates.

Material:

- Sheet steel

Surface finish:

- Zinc-plated, passivated

P. of	Model No.
1 pc(s).	8617.360



Also required:

- Second mounting plate, to fit the enclosure dimensions, refer to Rittal list of spares at www.rittal.com.



Accessories:

- For enclosures with a rear panel, the following may be used for optimum access to the rear mounting plate:
Glazed door instead of rear panel, see page 110
Lockable and adjacent door 8618.120, for enclosure dimensions W x H = 800 x 2000 mm, see page 110

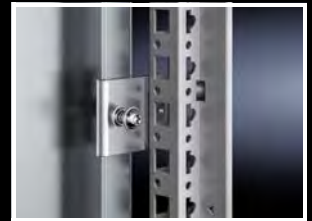

Interior installation

Mounting plates



Multi-functional installation kit for mounting plate

For installing the mounting plate from the rear of the enclosure

- Mounting position flush with the enclosure frame, position ± 0
- The mounting plate is removable from the front and rear for servicing

For 20 mm more installation depth in the enclosure

- Mounting position set back behind the enclosure frame, position ± 20 mm

For additional screw-fastening of the mounting plate

- For all mounting positions

P. of	Model No.
1 pc(s).	8617.370

Material:

- Sheet steel

Surface finish:

- Zinc-plated, passivated

Supply includes:

- Assembly parts

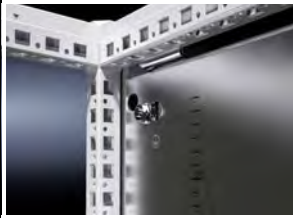

Slide rail

for mounting plate

For sliding the mounting plate in from the side. For mounting in a set-forward position.

Material:

- Sheet steel

Surface finish:

- Zinc-plated

Supply includes:

- Assembly parts

For enclosure width mm	P. of	Model No.
600	2 pc(s).	8617.400
800	2 pc(s).	8617.401
1200	2 pc(s).	8617.402

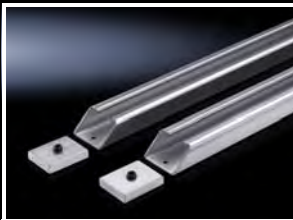

Cross-brace

for mounting plates

Additional horizontal rigidity for vibration damping and/or retrospective stabilisation of wide mounting plates. This brace may also be used as an attachment aid for heavy components.

Material:

- Sheet steel

Surface finish:

- Zinc-plated

Supply includes:

- 2 sections

For enclosure width mm	Model No.
1200	4333.120
1600	4333.160
1800	4333.180



Interior installation

Mounting plates

Partial mounting plate

To accommodate additional components inside the enclosure. Partial mounting plates can be used extremely flexibly, providing a platform for a diverse range of applications. For optional installation either upright as a vertical mounting surface, or flat as a horizontal base. For attachment either directly to the enclosure section or, with a set-forward construction, for example, to any mounting level in the enclosure using punched sections with mounting flanges. For multi-level installation one behind the other, partial mounting plates may be vertically hinged, via hinge attachment 8617.650, to allow rapid access to the levels behind.

Material:

- Sheet steel, 2.5 mm

Surface finish:

- Zinc-plated

Supply includes:

- Assembly parts

Note:

- Depending on the mounting situation, additional parts such as punched sections with mounting flanges may be required, see installation example on page 146



Accessories:

- Punched section with mounting flange for the inner and outer level, see page 150
- Hinge attachment 8617.650, see page 147

Installation examples:

See page 146

For installation in										Door width mm	Dimensions mm	P. of	Model No.
Enclosure width mm					Enclosure depth (side) mm								
400	600	800	1000	1200	400	500	600	800					
■	■				■		■			600	500 x 300	1 pc(s).	8617.510
	■					■	■			600	500 x 400	1 pc(s).	8617.520
	■						■			600	500 x 500	1 pc(s).	8617.530
	■	■					■	■		600	500 x 700	1 pc(s).	8617.540
	■						■			600	500 x 775	1 pc(s).	8617.550
■		■			■			■		800	700 x 300	1 pc(s).	8617.560
		■				■		■		800	700 x 400	1 pc(s).	8617.570
		■						■		800	700 x 700	1 pc(s).	8617.580
■			■		■					1000	900 x 300	1 pc(s).	8617.590
			■			■				1000	900 x 400	1 pc(s).	8617.600
	■		■				■			1000	900 x 500	1 pc(s).	8617.610
■				■	■					-	1100 x 300	1 pc(s).	8617.620
				■		■				-	1100 x 400	1 pc(s).	8617.630
	■			■			■			-	1100 x 500	1 pc(s).	8617.640



Interior installation

Mounting plates

Installation examples

Full installation in the width/depth

Choose a partial mounting plate 100 mm smaller than the nominal size of the enclosure. For example, a partial mounting plate with dimensions 500 x 700 mm can be installed in enclosures with nominal dimensions of 600 and 800 mm.

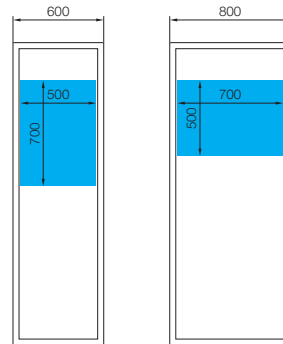

Full installation, set forward in the width/depth

For set-forward installation, punched sections with mounting flanges are required for the inner or outer mounting level, according to the enclosure depth.

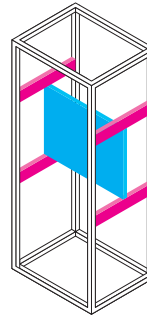

Full installation in the height

The sum total of partial mounting plates 100 mm should be smaller than the nominal size of the enclosure. For example, in a 2000 mm high enclosure, the sum total of partial mounting plates should not exceed 1900 mm.

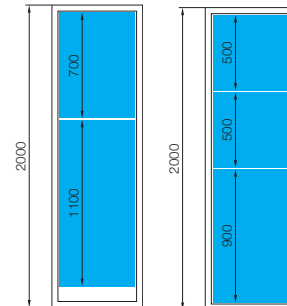

Partial installation



Also required:

- Punched section with mounting flange 23 x 64 mm **(A)** to match the enclosure width or depth, see page 150
- Punched section with mounting flange 23 x 64 mm **(B)** to match the enclosure height, see page 150

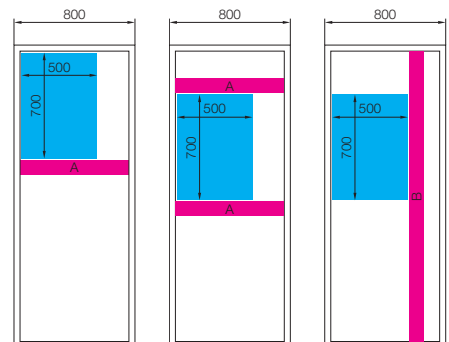

Door installation

Choose a partial mounting plate 100 mm smaller than the nominal size of the enclosure. For example, a partial mounting plate with dimensions 500 x 700 mm can be installed on the tubular door frame of enclosures with a nominal size of 600 mm.

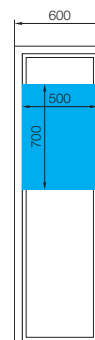

Interior installation

Mounting plates

Hinge attachment

for partial mounting plate

In conjunction with the mounting kit for swing frames, small, the partial mounting plate can be hinged to allow access to the components behind it for servicing.

Installation options:

- At the front, on the frame section
- Set back, in the enclosure depth
- At the side, in conjunction with the hinged side panel

Material:

- Steel

Surface finish:

- Zinc-plated

Supply includes:

- Assembly parts

P. of	Model No.
1 pc(s).	8617.650

! Also required:

- Installation kit for swing frame, small, for enclosure width 600 mm (8619.600) or 800 mm (8619.610), see page 192
- Punched section with mounting flange 23 x 64 mm according to the enclosure depth, see page 150



Examples

In the highest or lowest position

Front

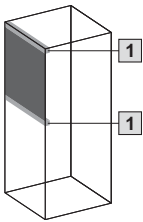

Set back

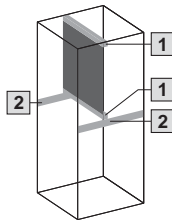

- 1 Installation kit for swing frame, small
- 2 Punched section with mounting flange 23 x 64 mm in accordance with the enclosure depth

In a central position

Front

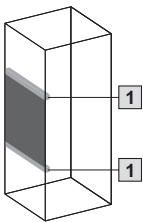

Set back

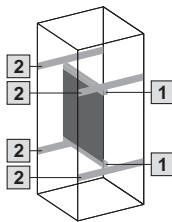

Transport handle

for mounting plates

For use at any given position in the side C-fold.

Benefits include:

- Adapts to users of different heights
- Optimised force transmission
- Simple handling

P. of	Model No.
2 pc(s).	2415.500





Enclosure frame

The patented profile is completely symmetrical across all levels and equipped with 25 mm system punchings that are consistently retained even across multiple enclosures.

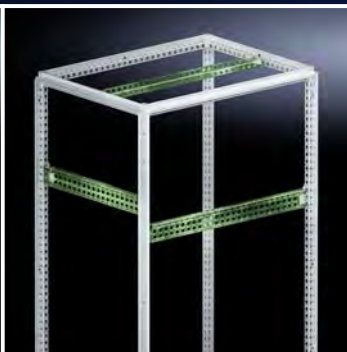
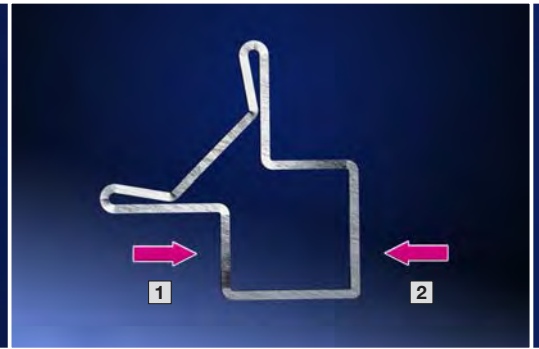

Punched section with mounting flanges for the outer mounting level

The punched section may optionally be used directly on the enclosure section or in combination with the punched section with mounting flange on the inner mounting level.



Cage nut

With their ergonomic form and integral automatic potential equalisation, the M6 or M8 cage nuts contribute to a high standard of work safety. They may be used on all levels of the VX25 enclosure system, as well as in all punched sections with 12.5 x 11 mm punchings.



Two mounting levels

The two mounting levels, spaced 25 mm apart, allow optimum flexibility and maximise the space available for interior installation.

- 1 Outer mounting level
- 2 Inner mounting level

Punched section with mounting flange for the inner mounting level

The punched section with mounting flange supports system configuration on a 25 mm pitch pattern across all levels of the VX25, even beyond enclosure boundaries. Cage nuts up to M8 may be used in the system punchings on three levels. In this way, your own components can be securely fastened with metric screws. Direct mounting on the horizontal enclosure section is also supported.

Punched section with mounting flange for the outer mounting level

The punched section is easily retro-fitted, even with the side panel already installed, because the rounded edges allow it to be screwed in. The additional C-fold may be used to support heavy installed equipment on the side panel or roof, or for attaching cable connectors.

Punched section with mounting flange, 14 x 39 mm

The punched section enables individual interior installation on the tubular door frame provided as standard.



Interior installation

Rail systems

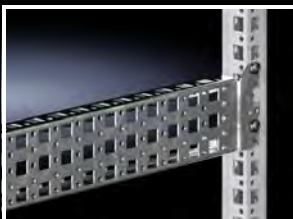
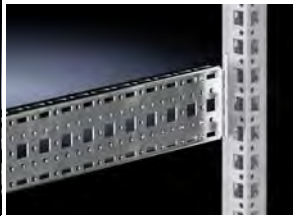

Punched section with mounting flange, 18 x 64 mm

For variable, individual interior installation of the enclosure frame on the outer mounting level. Simply locate into the system punchings from the outside and screw-fasten. System punchings on all four sides. With pre-fitted side panels or bayed enclosures, the punched sections with mounting flanges may also be fitted from the inside of the enclosure.

Installation options:

- On the outer mounting level, on the enclosure section
- On the outer mounting level, between two punched sections with mounting flanges 23 x 64 mm

Material:

- Sheet steel

Surface finish:

- Zinc-plated

Supply includes:

- Assembly parts

For enclosure width/height/depth mm	P. of	Model No.
300	4 pc(s).	8617.000
400	4 pc(s).	8617.010
500	4 pc(s).	8617.020
600	4 pc(s).	8617.030
800	4 pc(s).	8617.040
1000	4 pc(s).	8617.050
1200	4 pc(s).	8617.060

Accessories:

- Screws, see page 158
- Cable ties 2597.000, see page 188

Punched section with mounting flange, 23 x 64 mm

For variable, individual interior installation of the enclosure frame on the inner mounting level. Simply locate into punchings and screw-fasten. System punchings on all four sides. With slots at the top and bottom for cage nuts, for attaching your own components via metric screws.

Installation options:

- On the inner mounting level, on the enclosure section
- On identical punched sections with mounting flanges
- Base/plinth system VX in the width and depth, combined with a base/plinth installation bracket

Material:

- Sheet steel

Surface finish:

- Zinc-plated

Supply includes:

- Assembly parts

For enclosure width/height/depth mm	P. of	Model No.
300	4 pc(s).	8617.100
400	4 pc(s).	8617.110
500	4 pc(s).	8617.120
600	4 pc(s).	8617.130
800	4 pc(s).	8617.140
1000	4 pc(s).	8617.150
1200	4 pc(s).	8617.160
1400	4 pc(s).	8617.170
1600	4 pc(s).	8617.180
1800	4 pc(s).	8617.190
2000	4 pc(s).	8617.200
2200	4 pc(s).	8617.210

Accessories:

- Screws, see page 158
- Cable ties 2597.000, see page 188
- Cage nuts, see page 157
- Base/plinth installation bracket, see page 89

Interior installation

Rail systems

Punched section with mounting flange, 23 x 89 mm

For variable, individual interior installation of the enclosure frame on the inner mounting level. Simply locate into punchings and screw-fasten. System punchings on all four sides. With slots at the top and bottom for cage nuts, for attaching your own components via metric screws. Especially for cable routing in the base/plinth system VX, stainless steel and for the installation of busbar supports (non-magnetic stainless steel).

Installation options:

- On the inner mounting level, on the enclosure section
- On identical punched sections with mounting flanges
- Base/plinth system VX, stainless steel, in the width and depth, combined with a base/plinth installation bracket

Material:

- Stainless steel

Supply includes:

- Assembly parts

For enclosure width/depth mm	P. of	Model No.
400	2 pc(s).	8100.730
500	2 pc(s).	8100.731
600	2 pc(s).	8100.732
800	2 pc(s).	8100.733



Accessories:

- Screws, see page 158
- Cable ties 2597.000, see page 188
- Cage nuts, see page 157
- Base/plinth installation bracket, see page 89



Punched rail 18 x 39 mm

For variable, individual interior installation of the enclosure frame on the inner mounting level, may also be used in conjunction with other punched sections. Prepared at the rear to accommodate cable clamps for optimum cable routing inside the enclosure

Installation options:

- On the inner mounting level, on the enclosure section

Material:

- Sheet steel

Surface finish:

- Zinc-plated

Supply includes:

- Assembly parts

For enclosure width/depth mm	P. of	Model No.
400	4 pc(s).	8617.700
500	4 pc(s).	8617.710
600	4 pc(s).	8617.720
800	4 pc(s).	8617.730

Note:

- In enclosures with a mounting plate, two punched rails (as mounting plate slide rails) are already included with the supply



Accessories:

- Screws, see page 158
- Cable ties 2597.000, see page 188
- Cable clamps, see page 188

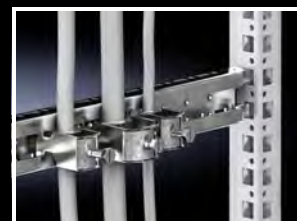

Interior installation

Rail systems



Support strip

For simple cable routing from the mounting plate to the door.

Installation options:

- On the inner and outer mounting level, on the enclosure section

Material:

- Sheet steel

Surface finish:

- Zinc-plated

Supply includes:

- Assembly parts

For enclosure width/ depth mm	Length mm	P. of	Model No.
400	340	20 pc(s).	4694.000
500	440	20 pc(s).	4695.000
600	540	20 pc(s).	4696.000
800	740	20 pc(s).	4697.000



Accessories:

- Screws, see page 158
- Cable ties 2597.000, see page 188



C rail 30/15

to EN 60 715

Installation options:

- On the inner mounting level, on the enclosure section

Material:

- Sheet steel

Surface finish:

- Zinc-plated

For enclosure width/ depth mm	Length mm	P. of	Model No.
500	455	6 pc(s).	4943.000
600	555	6 pc(s).	4944.000
800	755	6 pc(s).	4945.000
1000	955	6 pc(s).	4946.000
1200	1155	6 pc(s).	4947.000



Accessories:

- Cable clamps, see page 188
- Support bracket or spacer, see page 156
- Quick-assembly block, see page 156



Possible alternative:

- Rail for EMC shielding bracket and strain relief, see page 166

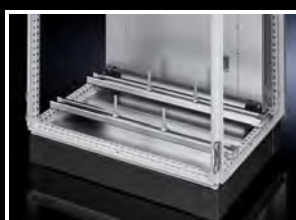

Support rail 48 x 26 mm

For heavy installed equipment such as transformers. T-head screw and slots in the support rail accommodate all mounting dimensions.

Installation options:

- On the inner mounting level, on the enclosure section

Material:

- Sheet steel

Surface finish:

- Zinc-plated

Supply includes:

- Assembly parts

For enclosure width mm	P. of	Model No.
600	2 pc(s).	8617.800
800	2 pc(s).	8617.810
1000	2 pc(s).	8617.820
1200	2 pc(s).	8617.830



Accessories:

- Punched section with mounting flange 23 x 64 mm for height-offset installation, see page 150



Interior installation

Rail systems

Support rail 75 x 20 mm

For heavy installed equipment such as base isolators or transformers.

Installation options:

- On the inner mounting level, on the enclosure section

Material:

- Sheet steel

Surface finish:

- Zinc-plated

Supply includes:

- Assembly parts

For enclosure width/ depth mm	P. of	Model No.	Model No.
		Slotted	Unslotted
400	4 pc(s).	4394.000	-
500	4 pc(s).	4395.000	-
600	4 pc(s).	4396.000	4396.500
800	4 pc(s).	4398.000	4398.500

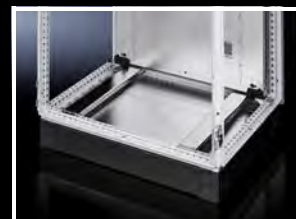
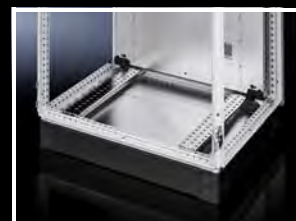

Support rail 65 x 42 mm

For heavy installed equipment such as base isolators or transformers.

Installation options:

- On the inner mounting level, on the enclosure section

Material:

- Steel

Surface finish:

- Zinc-plated

Supply includes:

- Assembly parts

For enclosure width mm	P. of	Model No.
600	2 pc(s).	8612.960
800	2 pc(s).	8612.980

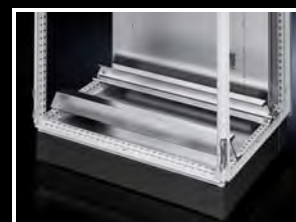

Support rail TS 35/15

For snap-mounting terminals or other components with a snap-in system to EN 60 715.

For enclosure width/ depth mm	Support rails length mm	P. of	Model No.
500	455	6 pc(s).	4933.000
600	555	6 pc(s).	4934.000
800	755	6 pc(s).	4935.000
1200	1155	6 pc(s).	4937.000
-	2000	6 pc(s).	2313.150



Support rail TS 35/7.5

For snap-mounting terminals or other components with a snap-in system to EN 60 715.

For enclosure width/ depth mm	Support rails length mm	P. of	Model No.
-	2000	6 pc(s).	2313.750

Interior installation

Rail systems



Mounting clip

For fast, secure attachment of:

- Cable ducts
- Mounting plates
- Mounting angles

on support rail TS 35/7.5 and 35/15 to EN 60 715. Simply pre-assemble the mounting clip on the part to be installed, then snap into position on the support rail.

P. of	Model No.
30 pc(s).	2309.000

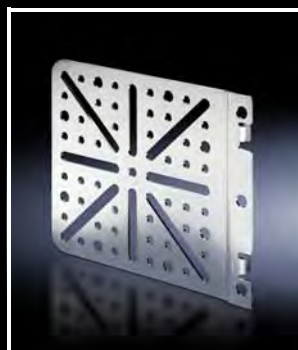

Mounting plate

Locatable

Installation options:

- On the inner and outer mounting level, on the enclosure section
- On punched sections with mounting flanges

Material:

- Sheet steel

Surface finish:

- Zinc-plated

Supply includes:

- Assembly screws

P. of	Model No.
4 pc(s).	8612.400

Accessories:

- Screws, see page 158
- Cable ties 2597.000, see page 188

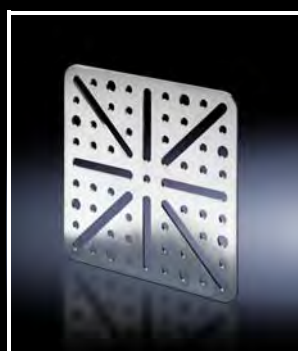

Mounting plate

Screw-fastened, large

Installation options:

- On all enclosures and mounting parts with system punchings on a 25 mm pitch pattern

Material:

- Sheet steel

Surface finish:

- Zinc-plated

Supply includes:

- Assembly screws

P. of	Model No.
4 pc(s).	8612.410

Accessories:

- Screws, see page 158
- Cable ties 2597.000, see page 188



Mounting plate

Screw-fastened, small

Installation options:

- On all enclosures and mounting parts with system punchings on a 25 mm pitch pattern

Material:

- Sheet steel

Surface finish:

- Zinc-plated

Supply includes:

- Assembly screws

P. of	Model No.
4 pc(s).	4532.000

Accessories:

- Screws, see page 158
- Cable ties 2597.000, see page 188

Mounting plate

with integral top-hat rail

For direct snap-mounting of components such as speed control, enclosure internal thermostat and hygostat.

Material:

- Sheet steel

Surface finish:

- Zinc-plated

Supply includes:

- Assembly parts

P. of	Model No.
1 pc(s).	7526.964



Mounting bracket

Installation options:

- On all enclosures and mounting parts with system punchings on a 25 mm pitch pattern

Material:

- Sheet steel

Surface finish:

- Zinc-plated

Supply includes:

- Assembly screws

P. of	Model No.
4 pc(s).	4597.000



Accessories:

- Screws, see page 158
- Cable ties 2597.000, see page 188



Interior installation

Assembly components

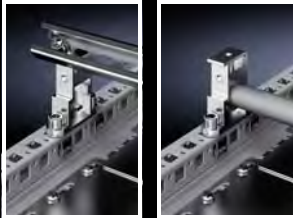
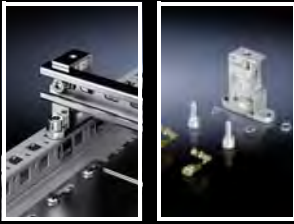

Bracket/spacer

For the attachment of C rails, punched rails or cable clamp rails (angle piece). On the sides, to accommodate square sections or tubes (\varnothing 20 mm). Attachment points with M8 thread.

Installation options:

- On the vertical and horizontal enclosure section
- On punched sections with mounting flanges for the inner mounting level

Material:

- Die-cast zinc

Supply includes:

- 1 pc(s). =
- 1 bracket/spacer
- 2 screws M8 x 16 mm
- 2 spring lock washers
- 2 cage nuts M8
- 2 serrated lock washers
- 2 screws

P. of	Model No.
6 pc(s).	4199.000

Accessories:

- Angle piece 4134.000, see page 156

Quick-assembly block

For a variety of installation options.

Installation options:

- On the vertical and horizontal enclosure section
- On punched sections with mounting flanges for the inner mounting level

Material:

- Die-cast zinc

Supply includes:

- 12 quick-assembly blocks
- 12 threaded blocks M8
- 24 screws M8 x 12 mm
- 24 square nuts M8

P. of	Model No.
12 pc(s).	4133.000

Accessories:

- Angle piece 4134.000, see page 156

Angle piece

For assembling mounting surfaces with a 45° incline.

With two mounting options as standard:

- Conductively connected to the subsurface
- Insulated from the mounting surface

Installation options:

- On the vertical and horizontal enclosure section
- On punched sections with mounting flanges for the inner mounting level
- On the bracket/spacer
- On the quick-assembly block

Material:

- Angle pieces: Die-cast zinc
- Insulating pieces: Plastic

Supply includes:

- 1 pc(s). =
- 1 angle piece
- 1 insulating piece
- 1 insulating screw
- 2 assembly screws
- 1 threaded block M8

P. of	Model No.
12 pc(s).	4134.000

Interior installation

Assembly components

Rail mounting bracket

For individual mounting of rails at a distance from the mounting surface.

Material:

- Sheet steel, zinc-plated

Rail mounting bracket	P. of	Model No.
Flat	20 pc(s).	2365.000
Inclined	20 pc(s).	2366.000

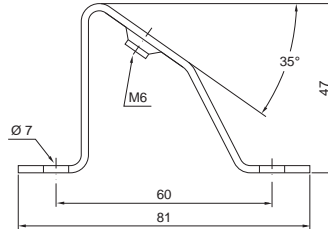
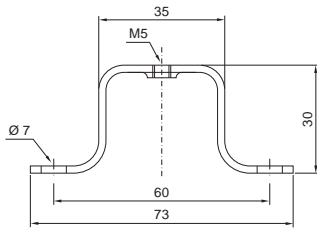

Cage nut

- For all-round mounting on the enclosure section
- The compression spring, designed as an insertion aid, ensures reliable mechanical and electrical connection in the system punchings.
- Simply slides in from the side
- Safely and easily released with a screwdriver

Installation options:

- On the vertical and horizontal enclosure section
- On punched sections with mounting flanges, 23 x 64 mm
- On punched sections with mounting flanges, 23 x 89 mm, stainless steel

Thread	P. of	Model No.
M6	20 pc(s).	4164.500
M8	20 pc(s).	4165.500



Threaded block

With snap-off insertion aid, made from die-cast zinc.

Installation options:

- On the vertical and horizontal enclosure section
- On punched sections with mounting flanges, 23 x 64 mm
- On punched sections with mounting flanges, 23 x 89 mm, stainless steel

Thread	P. of	Model No.
M6	50 pc(s).	4162.000
M8	50 pc(s).	4163.000



Interior installation

Assembly components

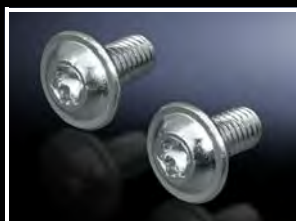

Multi-tooth screw

M6 x 12 to fit:

- Cage nuts (4164.500)
- Threaded blocks (4162.000)

M8 x 12 to fit:

- Cage nuts (4165.500)

Multi-tooth drive for optimum transmission of torque, an extended tool life and increased safety and reliability when tightening and loosening screw connections.

Type of screw	Dimensions mm	P. of	ModelNo.
Multi-tooth screws	M6 x 12	300 pc(s).	2504.500
	M8 x 12	300 pc(s).	2504.800
Metal multi-tooth screws	5.5 x 13	300 pc(s).	2486.600
Metal multi-tooth screws for stainless steel	5 x 13	300 pc(s).	2486.400
Self-tapping screws (hex screws)	M5 x 10	500 pc(s).	2504.000
Self-tapping screws	ST 4.8 x 16	300 pc(s).	2487.000

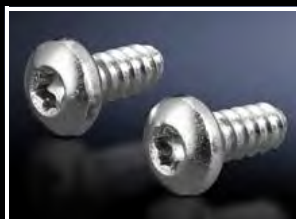

Metal multi-tooth screw

For the round holes \varnothing 4.5 mm in the enclosure section, punched rails and punched sections without mounting flanges.

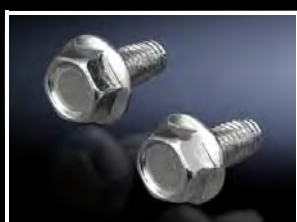

Self-tapping screw

For the round holes \varnothing 4.5 mm in the enclosure section, punched rails and punched sections without mounting flanges.



Self-tapping screw

Mark, drill and tighten in a single operation using electric or pneumatic tools.

For metal thickness: 0.8 – 3 mm

Length: 16 mm

Usable length: 9.5 mm

Width across flats: 8 mm



ENCLOSURES

POWER DISTRIBUTION

CLIMATE CONTROL

IT INFRASTRUCTURE

SOFTWARE & SERVICES



FRIEDHELM LOH GROUP



Component shelves

The component shelves for frame attachment enable the fast creation of support surfaces for devices; if necessary, they may also be equipped with telescopic slides. The shelves are slotted to support natural convection inside the enclosure. Additionally, the devices may be screw-fastened directly to these punchings to prevent slipping; no machining is required. The optional hinged cable support ensures secure cable routing into the enclosure.



EMC protection

The level of EMC protection in the VX25 bayed enclosure system is already high, but can be further significantly improved by adopting simple measures for cable entry. The rail for EMC shielding brackets provides strain relief as well as EMC contacting of inserted cables. The rail can be fitted on the horizontal or vertical enclosure section, as well as directly onto the mounting plate.

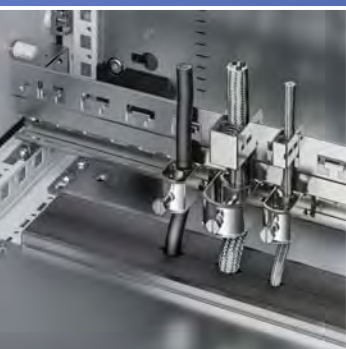

EMC cable glands

The EMC cable gland can be used for EMC-compatible insertion of individual cables. The lock nut creates a conductive connection with the enclosure. Cable glands can be used on all suitable surfaces on the enclosure.



LED system light

The LED system light is specifically designed to provide optimum illumination of the entire enclosure, when fitted both horizontally and vertically. Two different Fresnel structures ensure that all the light remains inside the enclosure, illuminating every last corner. For tool-free mounting directly into the system punchings using a system of clip-in hooks.

Easy connection

Connection is equally straightforward as assembly. The rotating connectors allow user-friendly connection, even in tight spaces. The wide-range power supply unit means that the light can be used anywhere in the world.

Thermostat/hygrostat

For optimum monitoring and adjustment of climate control.



Interior installation

Component shelves for frame attachment

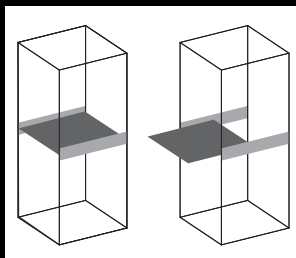

Component shelf for frame attachment

For enclosure width 600 and 800 mm

For installation in enclosures **without** 482.6 mm (19") accommodation.

Max. depth of component shelves =
Enclosure depth - 100 mm

Technical specifications:

- Mounting bolts or mounting rails may be installed on a 25 mm pitch pattern in the enclosure depth
- Mounting hole for handles provided.
- Slotted component shelf

Material:

- Sheet steel

Surface finish:

- Spray-finished

Colour:

- RAL 7035

Supply includes:

- Assembly parts

Enclosure width 600 mm

Load capacity N (static surface load)	500	500	500	500	1000	1000	1000	1000
Component shelf width mm	471	471	471	471	471	471	471	471
Component shelf depth mm	400	500	600	700	400	500	600	700
Component shelf height mm	29	29	29	29	45	45	45	45
Model No.	7164.035	7165.035	7166.035	7166.735	7464.035	7465.035	7466.035	7466.735

Enclosure width 800 mm

Load capacity N (static surface load)	500	500	500	500	1000	1000	1000	1000
Component shelf width mm	671	671	671	671	671	671	671	671
Component shelf depth mm	400	500	600	700	400	500	600	700
Component shelf height mm	29	29	29	29	45	45	45	45
Model No.	7184.035	7185.035	7186.035	7186.735	7484.035	7485.035	7486.035	7486.735



Also required:

Punched section with mounting flange, 23 x 64 mm, as installation kit for enclosure depth, see page 150	500	8617.120	8617.120	8617.120	8617.120	8617.120	8617.120	8617.120	8617.120
	600	8617.130	8617.130	8617.130	8617.130	8617.130	8617.130	8617.130	8617.130
	800	8617.140	8617.140	8617.140	8617.140	8617.140	8617.140	8617.140	8617.140



Accessories:

Telescopic slides		7061.000	7081.000	7161.000	7161.700	7064.000	7065.000	7066.000	7066.700
Handles for component shelves		5501.730	5501.730	5501.730	5501.730	5501.730	5501.730	5501.730	5501.730
Cable support, hinged, with anti-kink device and clamp for enclosure depth mm	≤ 600	7163.560	7163.560	7163.560	7163.560	7163.560	7163.560	7163.560	7163.560
	> 600	7163.565	7163.565	7163.565	7163.565	7163.565	7163.565	7163.565	7163.565

LED system light

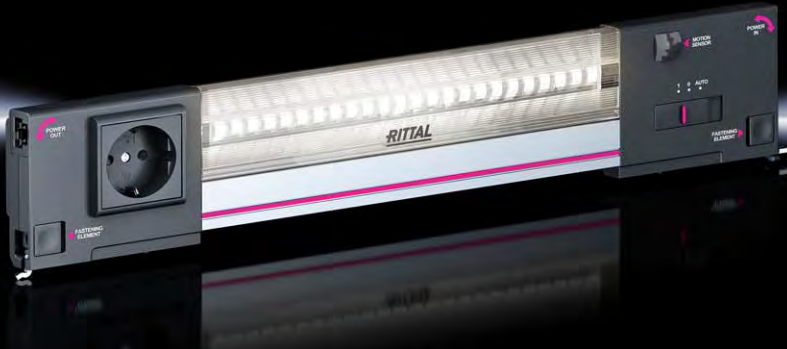

Baying enclosure system VX25 Page 54 Connection accessories Page 164

Benefits:

- Optimum illumination of the entire enclosure
- Optionally with clip, screw or magnetic attachment
- Equipment to suit every application

Material:

- Plastic
- Aluminium

Colour:

- Enclosure: RAL 7016

Light colour:





- 4000 K (neutral white)

Supply includes:

- Assembly screws

Note:

- Connection accessories should be ordered separately
- Further information on country-specific versions can be found on the Internet
- Other system lights, e.g. with a lower luminosity and for compact enclosures, can be found on the Internet

						
Model No.		2500.310	2500.300	2500.210	2500.200	2500.220
Output (lumens)		1200	1200	900	900	900
Length (mm)		437	437	437	437	437
Motion sensor		■	■	–	–	–
Rated operating voltage	100 – 240 V AC	■	■	■	■	–
	24 V DC	–	–	–	–	■
Equipment	Socket	■	–	■	–	–
	90° rotating connector	■	■	■	■	■
	Adjustable light direction	■	■	–	–	–
	Adjustable light distribution	■	■	■	■	■
Protection class		II (all-insulated)				III (SELV)
Approvals	UL	–	■	–	■	■
	cUL	–	■	–	■	■
	CCC	–	■	–	■	–
	ENEC	■	■	■	■	■
Installation type	Screw-fastening	■	■	■	■	■
	Clip attachment	■	■	■	■	■
	Magnetic attachment to surfaces (accessory)	–	■	–	■	■
Connection options	Infeed	3-pole	3-pole	3-pole	3-pole	2-pole
	Through-wiring	3-pole	3-pole	3-pole	3-pole	2-pole
	Door-operated switch (accessory)	–	–	■	■	■
Accessories						
Mounting kit magnet		–	2500.490	–	2500.490	2500.490
Door-operated switch		–	–	2500.460	2500.460	2500.460
Door-operated switch, UL		–	–	–	2500.470	2500.470
Also required: Connection accessories depending on application type						
Infeed, 2-pole		–	–	–	–	2500.410
Infeed, 3-pole		2500.400	2500.400	2500.400	2500.400	–
Infeed, 3-pole, UL		–	2500.500	–	2500.500	–
Through-wiring, 2-pole		–	–	–	–	2500.440
Through-wiring, 3-pole		2500.430	2500.430	2500.430	2500.430	–
Through-wiring, 3-pole, UL		–	2500.530	–	2500.530	–

Interior installation

LED system light



Connection accessories

for LED system light

The following components can be used for time-saving, easy installation of the lights:



Accessories:

- Cable tie 2597.000, see page 188

Connection cable for	UL	Length mm	P. of	Model No.	
				orange	black
[1] Infeed, 3-pole, 100 – 240 V AC	■	3000	1 pc(s).	2500.500	-
Infeed, 3-pole, 100 – 240 V AC	-	3000	5 pc(s).	2500.400	-
[2] Infeed, 2-pole, 100 – 240 V AC	-	3000	5 pc(s).	2500.420	-
[3] Infeed, 2-pole, 24 V DC	-	3000	5 pc(s).	-	2500.410
[4] Through-wiring, 3-pole, 100 – 240 V AC	■	1000	1 pc(s).	2500.530	-
Through-wiring, 3-pole, 100 – 240 V AC	-	1000	5 pc(s).	2500.430	-
[5] Through-wiring, 2-pole, 100 – 240 V AC	-	1000	5 pc(s).	2500.450	-
[6] Through-wiring, 2-pole, 24 V DC	-	1000	5 pc(s).	-	2500.440

- [A] Connection cable for infeed
- [B] Connection cable for through-wiring
- [C] Door-operated switch with connection cable (not required for LED system light with integral motion sensor)

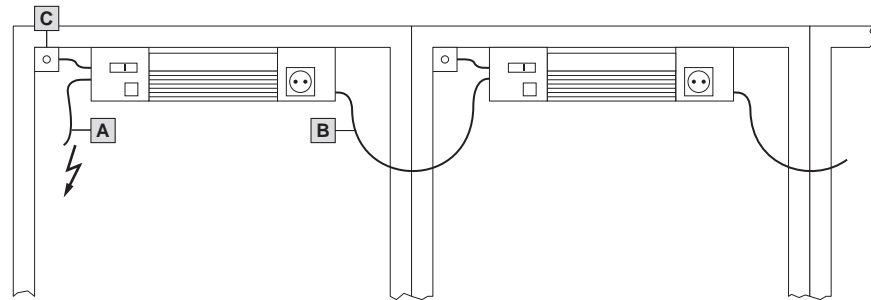

Door-operated switch

for LED system light

Supply includes:

- Assembly parts

Connection cable	UL	Length mm	To fit	P. of	Model No.
					black
Connection cable	-	800	230 V AC/24 V DC, 1 A	1 pc(s).	2500.460
	■	800		1 pc(s).	2500.470

Mounting kit magnet

for LED system light

For sticking onto the rear of lights without a socket.

P. of	Model No.
2 pc(s).	2500.490

Interior installation

Climate control accessories

Thermostat with strain relief

For controlling fan-and-filter units, roof-mounted fans, heaters and heat exchangers, and also as a signal generator for monitoring the enclosure internal temperature.

Design:

- Strain relief and contact hazard protection

Benefits:

- Flexible mounting on a vertical or horizontal 35 mm support rail to EN 50 022, and snap fastening in the enclosure section or on the mounting plate

Technical specifications:

- Bi-metal controller as a temperature-sensitive element with thermal feedback
- Contact population: Single-pole change-over contact as a quick-break contact
- Permissible contact load: Category 5 – 3 (heating): AC 10 (4) A (inductive load at $\cos \phi = 0.6$)/category 5 – 4 (cooling): AC 5 (4) A (inductive load at $\cos \phi = 0.6$)
- Switching difference: approx. $1 \text{ K} \pm 0.8 \text{ K}$
- Connection: Screwless spring terminal with PE entry

Colour:

- RAL 7016

Protection category IP to IEC 60 529:

- IP 20



Rated operating voltage V, \sim	Setting range	Operating temperature range	Storage temperature range	P. of	Model No.
24 - 230, 1~	+5°C...+60°C	-40°C...+60°C	-45°C...+70°C	1 pc(s).	3110.100

Hygrostat with strain relief

Switches on the heater and/or fan when a preset relative humidity in the enclosure is exceeded. This reduces the relative humidity, thereby preventing condensation from forming on assemblies or electronic components.

Design:

- Strain relief and contact hazard protection

Benefits:

- Flexible mounting on a vertical or horizontal 35 mm support rail to EN 50 022, and snap fastening in the enclosure section or on the mounting plate using the supplied adaptor

Technical specifications:

- Contact population: Single-pole change-over contact as a quick-break contact
- Permissible contact load: AC ~ 5 (0.2) A (inductive load at $\cos \phi = 0.6$)/DC = max. 20 W
- Setting range: 50 – 100% relative humidity
- Switching difference: approx. 4%

Colour:

- RAL 7016

Protection category IP to IEC 60 529:

- IP 20



Rated operating voltage V, \sim	Operating temperature range	Storage temperature range	P. of	Model No.
24 - 230, 1~ 12 - 75 (DC)	-40°C...+60°C	-45°C...+70°C	1 pc(s).	3118.100

Interior installation

EMC

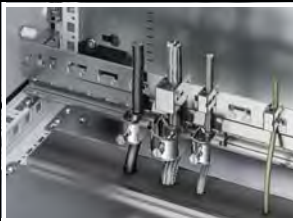
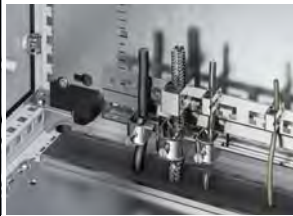

Rail

for EMC shielding bracket and strain relief

Combined rail for strain relief and EMC contacting of inserted cables.

Benefits:

- Additional contacting on the left or right of the rail via existing holes (9 mm diameter)
- Prepared for tool-free mounting of EMC shielding brackets

Installation options:

- On the horizontal/vertical enclosure section
- On the mounting plate, may also be fitted without a retaining bracket

Design:

- C rail to accommodate cable clamps
- T-head cut-outs on a 40 mm pitch pattern for cable clamping using cable ties

Material:

- Extruded aluminium section

Surface finish:

- Chrome-free passivated

Supply includes:

- 1 rail
- 2 retaining brackets
- Assembly parts

For enclosure width mm	Length mm	P. of	Model No.
600	553	1 pc(s).	2388.650
800	753	1 pc(s).	2388.850
1000	953	1 pc(s).	2388.050
1200	1153	1 pc(s).	2388.125



Also required:

- EMC shielding bracket, see page 166
- Cable clamps, see page 188



Accessories:

- Bracket/spacer, see page 156
- Quick-assembly block, see page 156
- Angle piece, see page 156
- Earth straps, see page 169
- Earthing braids, see page 169



Possible alternative:

- C rails 30/15, see page 152

EMC shielding bracket

Quick assembly without the use of tools:

Press the EMC shielding bracket against the cable shield and clip into the rail. Diameter changes are compensated in full by the spring of the EMC shielding bracket.

Material:

- Sheet steel

Surface finish:

- Zinc-plated

For shield diameter mm	P. of	Model No.
3 – 10	10 pc(s).	2388.100
4 – 15	10 pc(s).	2388.150
10 – 20	10 pc(s).	2388.200
15 – 28	10 pc(s).	2388.280

EMC cable gland

The cable sheathing may optionally be interrupted at the contact point or removed completely inside the enclosure. The cable shielding in the enclosure is retained. The supplied lock nut cuts automatically into the paint when screwed onto spray-finished enclosure surfaces, thus creating a conductive connection.

Protection category IP to IEC 60 529:

- IP 68

Cable glands, metric

Size	Cable diameter mm	Minimum shield diameter ¹⁾ mm	P. of	Model No.
M16	4.5 – 10	3	5 pc(s).	2843.160
M20	6 – 12	5	5 pc(s).	2843.200
M25	11 – 17	8	5 pc(s).	2843.250
M32	15 – 21	10	1 pc(s).	2843.320
M40	19 – 28	15	1 pc(s).	2843.400
M50	27 – 38	19	1 pc(s).	2843.500
M63	34 – 44	30	1 pc(s).	2843.630

¹⁾ Minimum shield diameter = cable diameter minus cable sheathing

EMC shield bus

Made of corrosion-proof steel strip, 75 mm² cross section, for cable shield contact.

Supply includes:

- Assembly parts

Rail length mm	Connections	P. of	Model No.
375	10	1 pc(s).	2413.375
550	16	1 pc(s).	2413.550



EMC earth clamp

The clamps may be used directly on the device or operating equipment on the mounting plate for cable shield contact.

Material:

- Sheet steel

Surface finish:

- Zinc-plated

Size mm	P. of	Model No.
4	50 pc(s).	2367.040
6	50 pc(s).	2367.060
8	50 pc(s).	2367.080
12	50 pc(s).	2367.120
16	50 pc(s).	2367.160
20	25 pc(s).	2367.200¹⁾

¹⁾ 2 mounting brackets

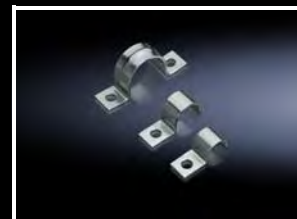

Contact cutter

The contact cutter enables EMC-compatible preparation of the contact point e.g. for earthing braids. Plastic-bound abrasive with guide pin for round system punchings. With location point for drill, grinder etc.

For	Model No.
Frame section	2414.000
Earthing bolts ¹⁾	2414.500

¹⁾ Not necessary with VX and TS

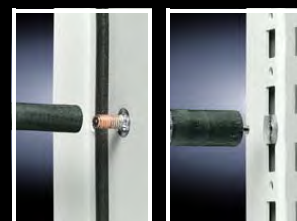

Contact paint

Contact paint prevents the corrosion of conductive, unprotected contact points.

Contents:

- 12 ml

P. of	Model No.
1 pc(s).	2415.000



Interior installation

for areas at risk from earthquakes



Earthquake kit

Material:

- Sheet steel

Surface finish:

- Zinc-plated

For enclosures W x H x D mm	P. of	Model No.
800 x 2000 x 600	1 pc(s).	8618.600

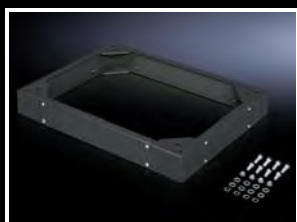

Earthquake base/plinth

Height 100 mm

- For stable attachment of the earthquake-resistant enclosure to the subsurface
- External metric M8 thread for a stable connection to the subsurface from the outside

Material:

- Corner pieces: Sheet steel, 5 mm
- Trim panels: Sheet steel, 2 mm

Surface finish:

- Powder-coated

Colour:

- RAL 7022

Supply includes:

- 1 pc(s). =
 - 4 corner pieces,
 - 2 depth stays,
 - 1 trim panel each front and rear
- Fully assembled.

For enclosures W x D mm	P. of	Model No.
800 x 600	1 pc(s).	8601.860



Earth strap

For configuring a reliable earthing connection with perfect contact

- With M8 ring terminals to match the earthing screws and bolts
- Length-optimised and ready to install

Connection	Cross-section mm ²	Length mm	P. of	Model No.
M8	4	170	5 pc(s).	2564.000
M8	16	170	5 pc(s).	2565.000
M8	25	170	5 pc(s).	2566.000
M8	4	300	5 pc(s).	2567.000
M8	10	300	5 pc(s).	2565.120
M8	16	300	5 pc(s).	2568.000
M8	25	300	5 pc(s).	2569.000



Earthing braid

Tin-plated copper, in various lengths and cross-sections with press-fitted contact rings. Earthing braids counteract the current displacement effect at high frequencies, whilst at the same time offering highly flexible connection opportunities.

Connection	Cross-section mm ²	Length mm	P. of	Model No.
M8	16	200	10 pc(s).	2412.216
M8	25	200	10 pc(s).	2412.225
M8	16	300	10 pc(s).	2412.316
M8	25	300	10 pc(s).	2412.325



Assembly parts

for earth straps

For fastening the earth straps and earthing braids to:

- Horizontal and vertical enclosure sections
- Punched sections with mounting flanges, 23 x 64 mm
- Punched sections without mounting flanges, 23 x 64 mm
- Gland plates

Size	P. of	Model No.
M8	10 pc(s).	2559.000



Also required:

- For mounting on horizontal and vertical enclosure sections: Cage nut, see page 157



PE busbar

699 mm long PE busbar with 42 pre-fitted screws, including terminal clamps up to 6 mm² (fine wire conductors), 10 mm² (single wire or multi-wire conductors) and main terminal clamp up to 35 mm².

P. of	Model No.
1 pc(s).	2364.000



Accessories:

- Cable retainer, see page 157



Interior installation

Earthing

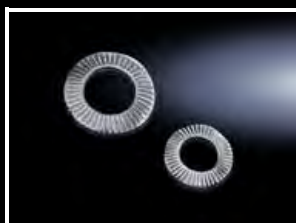

Contact washer

Serrated contact washers facilitate the secure connection of PE conductors, so there is no need to manually strip paint in the connection area.

Size	P. of	Model No.
M8	100 pc(s).	2335.000

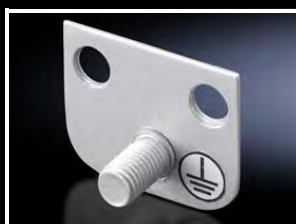

Central earthing point

For connecting

- Earth straps
- Earthing braids

to the vertical and horizontal enclosure sections. The connection bracket is connected to the enclosure frame with 2 screws and is securely contacted. Earth connection is via the threaded bolt M8 x 20 mm.

Material:

- Sheet steel

Surface finish:

- Zinc-plated

P. of	Model No.
1 pc(s).	7829.200

Supply includes:

- 1 connection bracket
- 2 assembly screws for mounting on the enclosure section
- 2 serrated washers
- 1 nut M8
- 1 contact washer M8
- 1 washer

ISV distribution enclosures

Installation kits

Installation kit

For mounting ISV installation modules in the enclosure.

Supply includes:

- Mounting aid support
- Contact hazard protection
- Assembly parts



Accessories:

- Cross rail, see page 178
- Mounting angle, see page 178
- Depth stay, see page 178
- Equipment support connector, see page 178

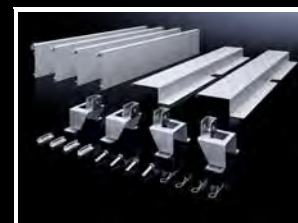

For enclosure width mm	600	600	850	1100
For enclosure height mm	1800	2000	2000	2000
For enclosure depth mm	400 500 600	400 600	400 600	400 600
To fit Model No.	8457.000/8684.000/ 8685.000/8686.000	8452.000/8604.000/ 8606.000	9666.916/9666.956	9666.926/9666.966
Width units (WU) @ 250 mm	2	2	3	4
Height units (U) @ 150 mm	11	12	12	12
Note on Model No.	Mounting angle 9666.711 additionally required	Mounting angle 9666.712 additionally required	Mounting angle 9666.712 additionally required	Mounting angle 9666.712 and depth stay 9666.732 additionally required
P. of	1 pc(s).	1 pc(s).	1 pc(s).	1 pc(s).
Model No.	9666.932	9666.902	9666.912	9666.922

ISV distribution enclosures

Installation modules

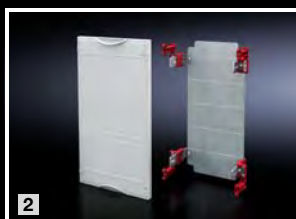

1 Contact hazard protection modules

- For covering free installation areas
- Cover is prepared for a lead seal

Material:

– Cover: Polystyrene (PS)

Colour:

– RAL 7035

2 Mounting plate modules

- With mounting plate made from 2 mm zinc-plated sheet steel
- Cover is prepared for a lead seal
- Possible installation depth 105 – 140 mm

Size				P. of	1 Contact hazard protection		2 Mounting plate	
Width unit		Height unit			Interior installation	Model No.	Mounting plate dimensions mm	Model No.
WU	mm	U	mm					
1	250	1	150	1 pc(s).	Empty module	9666.000	188 x 116	9666.080
1	250	2	300	1 pc(s).		9666.010	188 x 266	9666.090
1	250	3	450	1 pc(s).		9666.020	188 x 416	9666.100
1	250	4	600	1 pc(s).		9666.030	188 x 566	9666.110
2	500	1	150	1 pc(s).		9666.040	438 x 116	9666.120
2	500	2	300	1 pc(s).		9666.050	438 x 266	9666.130
2	500	3	450	1 pc(s).		9666.060	438 x 416	9666.140
2	500	4	600	1 pc(s).		9666.070	438 x 566	9666.150
3	750	2	300	1 pc(s).		9666.053	688 x 266	9666.133
3	750	3	450	1 pc(s).		9666.063	688 x 416	9666.143
3	750	4	600	1 pc(s).		9666.073	–	–

1 WU $\hat{=}$ 250 mm
1 U $\hat{=}$ 150 mm

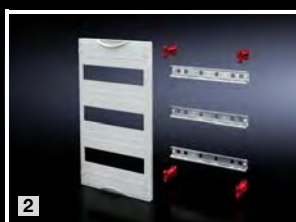

1 Support rail modules

- For installing terminal blocks, switchgear, etc.
- Support rails 35/15 mm
- Adjustable on a 25 mm pitch pattern
- Cover is prepared for a lead seal

Material:

– Cover: Polystyrene (PS)

Colour:

– RAL 7035



Accessories:

– Cover strips for DIN rail mounted device modules, see page 177

2 DIN rail mounted device modules

- To accommodate DIN rail mounted devices
- Support rails 35/15 mm
- Cover is prepared for a lead seal

Size				P. of	1 Support rails		2 DIN rail mounted devices	
Width unit		Height unit			Number of support rails	Model No.	Mechanical interior installation ¹⁾	Model No.
WU	mm	U	mm					
1	250	1	150	1 pc(s).	1	9666.160	12 pitch units (1 x 12 x 18 mm)	9666.240
1	250	2	300	1 pc(s).	2	9666.170	24 pitch units (2 x 12 x 18 mm)	9666.250
1	250	3	450	1 pc(s).	3	9666.180	36 pitch units (3 x 12 x 18 mm)	9666.260
1	250	4	600	1 pc(s).	4	9666.190	48 pitch units (4 x 12 x 18 mm)	9666.270
2	500	1	150	1 pc(s).	1	9666.200	24 pitch units (2 x 12 x 18 mm)	9666.280
2	500	2	300	1 pc(s).	2	9666.210	48 pitch units (4 x 12 x 18 mm)	9666.290
2	500	3	450	1 pc(s).	3	9666.220	72 pitch units (6 x 12 x 18 mm)	9666.300
2	500	4	600	1 pc(s).	4	9666.230	–	–
3	750	2	300	1 pc(s).	2	9666.213	72 pitch units (6 x 12 x 18 mm)	9666.293
3	750	3	450	1 pc(s).	3	9666.223	108 pitch units (9 x 12 x 18 mm)	9666.303

1 WU $\hat{=}$ 250 mm
1 U $\hat{=}$ 150 mm

¹⁾ No. of panels x pitch units x width

ISV distribution enclosures

Installation modules

Connection terminal blocks

- For connecting copper and aluminium conductors
- Single-wire or multi-wire conductors with crimped wire end ferrule or laminated copper bar

Material:
– Duroplastic

Colour:
– RAL 7035

Type	Connection of round conductors mm ²	Clamping area for laminated copper bars, W x H mm	P. of	Model No.	Page
1 250 A, 5-pole	1 x 16 – 150 or 2 x 16 – 70	17 x 21	1 pc(s).	9666.340	
400 A, 5-pole	1 x 50 – 240 or 2 x 25 – 120	25 x 21	1 pc(s).	9666.350	

Also required

Description	Size				P. of	Model No.	Page
	Width unit		Height unit				
	WU	mm	U	mm			
2 Mounting kit for connection terminal block	1	250	3	450	1 pc(s).	9666.310	
Contact hazard protection modules	1	250	3	450	1 pc(s).	9666.020	172

1 WU \geq 250 mm
1 U \geq 150 mm

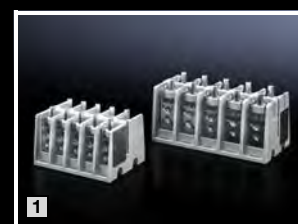

NH fuse-switch disconnecter modules

- Suitable for accommodating NH fuse-switch disconnectors for mounting plate assembly
- Cover is prepared for a lead seal

Material:
– Cover: Polystyrene (PS)

Colour:
– RAL 7035

Note:
– Blanking cover 9666.665 should be used to seal unneeded cut-outs for NH fuse-switch disconnectors size 00.

To fit NH disconnector		Size				P. of	Model No.	Page
Size	Model No.	Width unit		Height unit				
		WU	mm	U	mm			
2 pc(s), size 00	9344.000/.010/ .020/.030/.040/.050	1	250	2	300	1 pc(s).	9666.380	
4 pc(s), size 00		2	500	2	300	1 pc(s).	9666.390	
1 pc(s), size 1	9344.100/.110/ .130/.150	1	250	3	450	1 pc(s).	9666.400	
1 pc(s), size 2	9344.200/.210/ .230/.250	1	250	3	450	1 pc(s).	9666.410	
1 pc(s), size 3 or 2 pc(s), size 2	9344.300/.310/ .330/.350	2	500	3	450	1 pc(s).	9666.060 ¹⁾	172
						1 pc(s).	9666.420 ¹⁾	173

1 WU \geq 250 mm
1 U \geq 150 mm

¹⁾ Module unit consisting of disconnector cross-member 9666.420 and contact hazard protection module 9666.060



Disconnecter cross-member for NH fuse-switch disconnecter, size 2/3

- Suitable for the accommodation of NH fuse-switch disconnectors for mounting plate assembly

To fit NH disconnector		Size				P. of	Model No.	Page
Size	Model No.	Width unit		Height unit				
		WU	mm	U	mm			
1 pc(s), size 3 or 2 pc(s), size 2	9344.300/.310/ .330/.350	2	500	3	450	1 pc(s).	9666.420	

Also required

Contact hazard protection modules	1 pc(s).	9666.060	172
-----------------------------------	----------	----------	-----



ISV distribution enclosures

Installation modules



NH slimline fuse-switch disconnecter modules

For NH slimline fuse-switch disconnectors, sizes 00 to 3 (100/185 mm bar centre distance).

Material:

– Cover: Polystyrene (PS)

Colour:

– RAL 7035

Note:

- Busbars are not included with the supply
- To ensure problem-free cable connection, a contact hazard protection module or an N/PE busbar module must be installed above or below the NH slimline fuse-switch disconnecter modules

Type	To fit NH slimline fuse-switch disconnectors Model No.	Size				P. of	Model No.	Page
		Width unit		Height unit				
		WU	mm	U	mm			
100 mm module, 3-pole, max. 3 x size 00	9346.020 9346.030	1	250	3	450	1 pc(s).	9666.570	
100 mm module, 3-pole, max. 6 x size 00		2	500	3	450	1 pc(s).	9666.580	
100 mm module, 3-pole, max. 10 x size 00		3	750	3	450	1 pc(s).	9666.583	
185 mm module, 3-pole, max. 8 x size 00/ 4 x size 1, 2, 3	9677.XXX	2	500	5	750	1 pc(s).	9666.550	
185 mm module, 3-pole, max. 12 x size 00/ 6 x size 1, 2, 3		3	750	5	750	1 pc(s).	9666.560	

Also required

Contact hazard protection modules	172
Busbar modules N/PE	175
1 WU \triangleq 250 mm 1 U \triangleq 150 mm	



Circuit-breaker modules

- Suitable for accommodating standard circuit-breakers from ABB, Eaton, Schneider Electric and Siemens
- Cover is prepared for a lead seal

Material:

– Cover: Polystyrene (PS)

Colour:

– RAL 7035

Note:

- Attachment of the circuit-breakers and the corresponding cut-out dimensions for the cover are shown in the enclosed assembly instructions
- Circuit-breakers are not included with the supply

For circuit-breakers	Size				P. of	Model No.
	Width unit		Height unit			
	WU	mm	U	mm		
up to 250 A	1	250	2	300	1 pc(s).	9666.430
up to 630 A	2	500	3	450	1 pc(s).	9666.440

1 WU \triangleq 250 mm
1 U \triangleq 150 mm

ISV distribution enclosures

Installation modules

Meter mounting board module

- Open module for internal measurements
- Clearance depth available for meter installation 170 mm

Material:

- Meter mounting board: Polystyrene (PS)

Colour:

- RAL 7035

Note:

- The meter mounting board module does not comply with meter mounting board standard DIN 43 870/VDE 0603 and does not meet the conditions for total insulation. Use in un-metered areas only by arrangement with the local electricity supply company.
- 1 contact hazard protection module/DIN rail-mounted device module or support rail module with 1 WU and at least 1 U is required both above and below the module.



Size				P. of	Model No.	Page
Width unit		Height unit				
WU	mm	U	mm			
1	250	3	450	1 pc(s).	9666.640	

Also required

Contact hazard protection modules	172
Support rail modules	172
DIN rail-mounted device modules	172

- 1 WU \triangleq 250 mm
- 1 U \triangleq 150 mm

Busbar modules N/PE

- For attaching the busbars for N and PE
- Cover is prepared for a lead seal

Material:

- Cover: Polystyrene (PS)

Colour:

- RAL 7035

Note:

- Busbars are not included with the supply



For busbars mm	Size				P. of	Model No.
	Width unit		Height unit			
	WU	mm	U	mm		
12 x 5 to 30 x 10 mm	1	250	2	300	1 pc(s).	9666.590
	2	500	2	300	1 pc(s).	9666.600
	3	750	2	300	1 pc(s).	9666.603

- 1 WU \triangleq 250 mm
- 1 U \triangleq 150 mm

ISV distribution enclosures

Installation modules



Busbar modules

For assembling bus-mounting fuse bases E18, E27, E33 and D-Switch as well as NH fuse-switch disconnectors, sizes 000 and 00 (3-pole, 60 mm bar centre distance).

Note:

- Busbars are not included with the supply

Material:

- Cover: Polystyrene (PS)

Colour:

- RAL 7035

Size				To fit		P. of	Model No.	Page
Width unit		Height unit		Fusible elements Model No.	NH disconnectors Model No.			
WU	mm	U	mm					
1	250	2	300	3418.010 3427.010 3433.010 9340.950	9343.000 ¹⁾ 9343.020 ¹⁾ 9343.040 ¹⁾ 3431.020 3431.030 3431.035	1 pc(s).	9666.520	
2	500	2	300		3431.020 3431.030 3431.035	1 pc(s).	9666.530	
3	750	2	300		3431.020 3431.030 3431.035	1 pc(s).	9666.533	

Accessories

Blanking cover		10 pc(s).	9666.660	177
----------------	--	--------------	----------	-----

1 WU $\hat{=}$ 250 mm

1 U $\hat{=}$ 150 mm

¹⁾ A depth extension frame 9666.680 should additionally be used to ensure unrestricted connection.
NH fuse-switch disconnectors size 00 cannot be combined with other equipment.

Cover strips

for DIN rail mounted device modules

For sealing unused component cut-outs in DIN rail mounted device modules, max. 12 pitch units (12 x 18 mm), divisible every 9 mm.

Material:

– ABS

Colour:

– RAL 7035

P. of	Model No.
5 pc(s).	9666.650

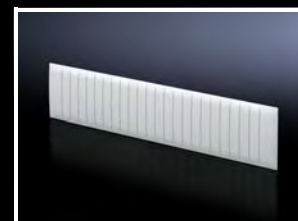

Blanking cover

- For sealing unused cut-outs
- To fit bus-mounting fuse base, D-Switch and NH fuse-switch disconnecter size 000 (3-pole, 60 mm busbar systems) in busbar modules (9666.520/.530/.533)
- Width: 16 – 34 mm variable

Material:

– Polypropylene (PP)

Colour:

– RAL 7035

P. of	Model No.
10 pc(s).	9666.660

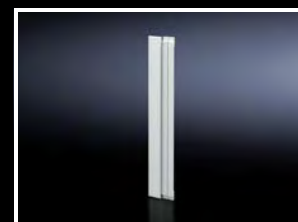

Blanking cover

for disconnectors, size 00

- For sealing unused cut-outs with NH fuse-switch disconnectors, size 00, in NH fuse-switch disconnector modules (9666.380/.390)
- Width: 117 mm

Material:

– PVC

Colour:

– RAL 7035

P. of	Model No.
1 pc(s).	9666.665



Wiring brackets

For tool-free external mounting on support rails TS 35/15 for cable routing on the rear of support rail modules.

Material:

– Polyamide (PA 6.6)

P. of	Model No.
10 pc(s).	9666.670



Depth extension frame

For extending the depth of the contact hazard protection cover. Allows unrestricted connection of NH fuse-switch disconnectors, size 00 (3-pole, 60 mm busbar systems).

Material:

– Polystyrene (PS)

Colour:

– RAL 7035

Size				P. of	Model No.
Width unit		Height unit			
WU	mm	U	mm		
1	250	2	300	1 pc(s).	9666.680

1 WU Δ 250 mm
1 U Δ 150 mm

Note:

– NH fuse-switch disconnectors, size 00, with covers and depth extension frame cannot be used in conjunction with other equipment.



ISV distribution enclosures

Accessories



Cross rails

For horizontal sub-division of the support frame in the enclosure.

Material:

– Sheet steel

Surface finish:

– Zinc-plated

Width unit		P. of	Model No.
WU	mm		
2	500	2 pc(s).	9666.722
3	750	2 pc(s).	9666.723
4	1000	2 pc(s).	9666.724

1 WU \triangleq 250 mm



Mounting angles

For vertical sub-division of the support frame in the enclosure.

Material:

– Sheet steel

Surface finish:

– Zinc-plated

Height unit		P. of	Model No.
U	mm		
2	300	2 pc(s).	9666.702
3	450	2 pc(s).	9666.703
4	600	2 pc(s).	9666.704
5	750	2 pc(s).	9666.705
6	900	2 pc(s).	9666.706
7	1050	2 pc(s).	9666.707
11	1650	2 pc(s).	9666.711
12	1800	2 pc(s).	9666.712

1 U \triangleq 150 mm



Accessories:

– Equipment support connector, see page 178



Depth stay

for installation kits ISV

For attaching the installation kit in the enclosure.

Material:

– Sheet steel

Surface finish:

– Zinc-plated

For enclosure depth mm	To fit Model No.	P. of	Model No.
400 500 600	9666.901	2 pc(s).	9666.732
	9666.902		
	9666.911		
	9666.912		
	9666.921		
	9666.922		
	9666.931		
	9666.932		

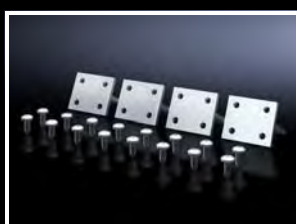

Equipment support connector

■ For connecting 2 mounting angles

■ Increases the stability of the frame structure

Material:

– T-section: Aluminium

P. of	Model No.
4 pc(s).	9666.740



ENCLOSURES POWER DISTRIBUTION CLIMATE CONTROL IT INFRASTRUCTURE SOFTWARE & SERVICES



FRIEDHELM LOH GROUP



Gland plates

The modular base assembly allows completely flexible cable entry into the VX25, adapted to your individual requirements. Essential cable clamping takes place in the base/plinth area, directly above the insertion point, or on the mounting plate.



Cable duct

In addition to the DIN punchings, the mounting holes of Rittal cable ducts also have punchings on a 25 mm pitch pattern, completely eliminating the need for any machining. Components are simply screw-fastened into the round holes. The screw heads may be securely covered with an isolator cap for insulation purposes.

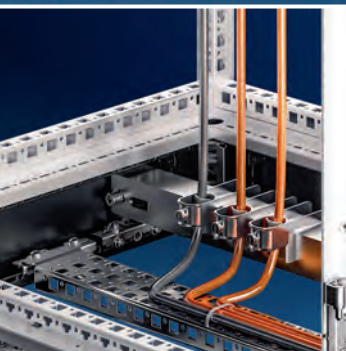

Cable clamping

Various options are available for cable clamping and are used identically both inside the enclosure and in the base/plinth. By relocating cable clamping into the base/plinth area, more mounting space remains inside the enclosure, rather than being lost to allow for bending radii.

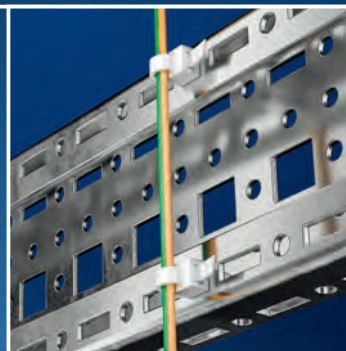

Cable ties

Simple, super-fast attachment of cables to all round holes on the enclosure and punched sections, by simply clipping into place.



Cable entry on surfaces

There are a number of options available, from a simple stepped collar through to a sealing frame, which also allows the insertion of pre-assembled cables with connectors.



Cable conduit and cable conduit holder

Allows crush-proof cable routing to moving parts such as doors, with minimal assembly work.



Baying enclosure system VX25

Cable management

Cable entry



Cable entry plate

for

- Cable entry grommets
 - Connector grommets
- instead of segments from the standard divided gland plates

Material:

- Sheet steel

Surface finish:

- Zinc-plated

Protection category IP to IEC 60 529:

- IP 55 in conjunction with cable entry grommets or connector grommets

Supply includes:

- Assembly parts

Enclosure width mm	Cut-outs per plate	P. of	Model No.
600	5	2 pc(s).	8619.800
800	8	2 pc(s).	8619.801
1000	4	4 pc(s).	8619.802
1200	6	4 pc(s).	8619.803



Also required:

- Cable entry grommet, see page 182 or
- Connector grommet, see page 182

Three examples from a wide range of possibilities

The diagrams show three examples for positioning cable entry plates instead of segments from the three-piece gland plates supplied as standard. They can be positioned to fit the mounting plate. Thanks to the enclosure symmetry, where dimensions permit, cable entry plates may also be inserted in the enclosure depth, right and left, analogous to the gland plates.

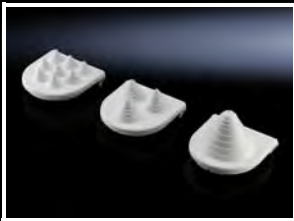
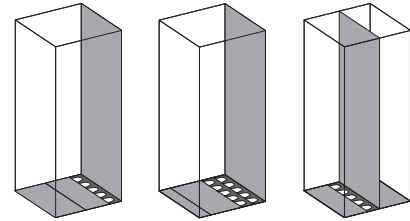

Cable entry grommet

In conjunction with the cable entry plate, supports simple, fast sealing of cables inserted into the base area of enclosures.

Material:

- Body: Polypropylene
- Cover: Thermoplastic elastomer

Protection category IP to IEC 60 529:

- IP 55 if installed correctly

Cables per grommet	Max. Ø mm	P. of	Model No.
8	13	25 pc(s).	4316.000
3	21	25 pc(s).	4317.000
1	47	25 pc(s).	4318.000

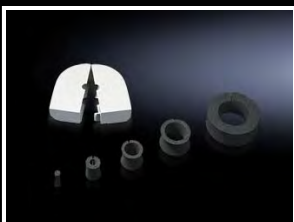

Connector grommet

Suitable for cable diameters from 8 to 36 mm.

Material:

- Outer cover: Polypropylene covered with thermoplastic elastomer
- Seal: Cellular rubber

Protection category IP to IEC 60 529:

- IP 55 if installed correctly

P. of	Model No.
10 pc(s).	4311.000

Section for cable entry, centre

For top-mounting on gland plates.

Material:

- Extruded aluminium section
- Seal: PU foam
- Cross-section: 30 x 25 mm

Protection category IP to IEC 60 529:

- IP 55 if installed correctly

Supply includes:

- Plug-in sections, incl. foam rubber clamp strips

Note:

- You will need two pieces per cable entry point.
- From an enclosure width of 1000 mm, the base assembly is divided into two sections in the width. Two cable entry points (left/right) may be used.

For enclosure width mm	P. of	Model No.
600	2 pc(s).	8618.800
800	2 pc(s).	8618.801
1000	4 pc(s).	8618.802
1200	4 pc(s).	8618.803



Accessories:

- Cable clamp rail, see page 187

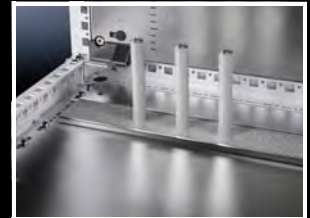
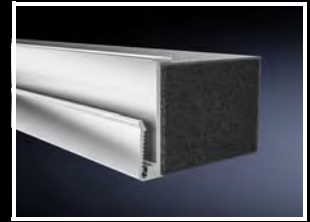

Section for cable entry, rear

For top-mounting on the gland plate and enclosure frame.

Material:

- Extruded aluminium section
- Seal: PU foam
- Cross-section: 30 x 25 mm

Protection category IP to IEC 60 529:

- IP 55 if installed correctly

Supply includes:

- Plug-in sections, incl. foam rubber clamp strips

Note:

- You will need two pieces per cable entry point.
- From an enclosure width of 1000 mm, the base assembly is divided into two sections in the width. Two cable entry points (left/right) may be used.

For enclosure width mm	P. of	Model No.
600	2 pc(s).	8618.810
800	2 pc(s).	8618.811
1000	4 pc(s).	8618.812
1200	4 pc(s).	8618.813



Accessories:

- Cable clamp rail, see page 187



Cable management

Cable gland



Cable gland, brass

Benefits:

- Because the gland and lock nut are sold together in a single pack, this saves additional ordering and storage
- Clamping membranes for even tightening and strain relief to protect the cables

Material:

- Brass
- Seal: TPE/NBR

Surface finish:

- Nickel-plated

Protection category IP to IEC 60 529:

- IP 68 (1 bar, 30 min.)

Approvals:

- VDE

Size	P. of	Model No.
M12 x 1.5	15 pc(s).	2411.801
M16 x 1.5	15 pc(s).	2411.811
M20 x 1.5	10 pc(s).	2411.821
M25 x 1.5	10 pc(s).	2411.831
M32 x 1.5	5 pc(s).	2411.841
M40 x 1.5	4 pc(s).	2411.851
M50 x 1.5	2 pc(s).	2411.861
M63 x 1.5	1 pc(s).	2411.871



Cable gland, polyamide

Benefits:

- Because the gland and lock nut are sold together in a single pack, this saves additional ordering and storage
- Clamping membranes for even tightening and strain relief to protect the cables

Material:

- Polyamide 6
- Seal: Neoprene

Colour:

- RAL 7035

Protection category IP to IEC 60 529:

- IP 68 (1 bar, 30 min.)

Approvals:

- VDE

Size	P. of	Model No.
M12 x 1.5	50 pc(s).	2411.601
M16 x 1.5	50 pc(s).	2411.611
M20 x 1.5	50 pc(s).	2411.621
M25 x 1.5	25 pc(s).	2411.631
M32 x 1.5	15 pc(s).	2411.641
M40 x 1.5	5 pc(s).	2411.651
M50 x 1.5	5 pc(s).	2411.661
M63 x 1.5	3 pc(s).	2411.671

Cable management

Cable gland



The connector gland proves that sometimes "less is more": significantly faster installation, a flexible sealing system for different cable diameters, and simple cable entry with pre-assembled cables. Low installation costs, a high degree of protection and flexible cable management – enjoy added value with this latest generation of cable entry solutions from Rittal.

Benefits:

- Cable diameters 4 – 16 mm
- Simple cable entry for pre-assembled cables
- Individual cables can be added or replaced without dismantling the sealing frame
- Sealing modules remain safely attached to their cables

Sealing frame

For pre-assembled cables with connectors.

External mounting on 24-pole or 16-pole connector cut-outs in:

- Module plates for divider panel
- Metal gland plates

Material:

- Frame: Polyamide
- Flat seal: CR

Protection category IP to IEC 60 529:

- IP 64

NEMA protection category:

- NEMA 12

Supply includes:

- Assembly parts

For modules 20 x 20 mm	For cut-out	P. of	Model No.
10 pc(s).	24-pole	1 pc(s).	2400.900
8 pc(s).	16-pole	1 pc(s).	2400.910



Accessories:

- Module plates for divider panel, see from page 99

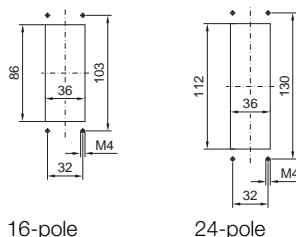

16-pole

24-pole



Sealing module

For sealing cables and lines in conjunction with a sealing frame. 20 x 20 mm and 40 x 40 mm sealing modules may be combined.

Material:

- Hard shell: Polyamide
- Seal: TPE 2

Protection category IP to IEC 60 529:

- IP 64

NEMA protection category:

- NEMA 12

Sealing modules 20 x 20 mm

Sealing range	P. of	Model No.
4 – 6 mm	10 pc(s).	2400.920
6 – 9 mm	10 pc(s).	2400.930
Solid	10 pc(s).	2400.970

Sealing modules 40 x 40 mm

Sealing range	P. of	Model No.
9 – 12 mm	10 pc(s).	2400.940
12 – 16 mm	10 pc(s).	2400.950
Solid	10 pc(s).	2400.960



Stepped collar

for wall thicknesses from 1.5 to 4.5 mm

For cable entry, simply cut off at the required level to match the cable diameter.

Material:

- Plastic to UL 94-HB

Protection category IP to IEC 60 529:

- IP 54 with careful cable entry

For hole	Sealing range mm	P. of	Model No.
M20	5 – 16	100 pc(s).	2899.200
M25	5 – 21	50 pc(s).	2899.250
M32	13 – 26.5	25 pc(s).	2899.320
M40	13 – 34	20 pc(s).	2899.400



Cable management

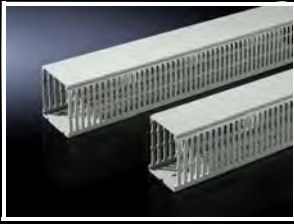

Cable duct

- With special DIN punchings for direct mounting on the enclosure section or on surfaces such as mounting plates.
- If the mounting plate is installed flush with the enclosure frame at the rear (installation position ± 0 mm), the horizontally mounted cable ducts are aligned with the cable ducts mounted on the enclosure section.
- Cable duct 50 mm wide for individually sited VX25 enclosures with side panel on the vertical section, on the left and right adjacent to the mounting plate.
- Cable duct 100 mm for mounting on the vertical enclosure frame with bayed enclosures.

Technical specifications:

- Depth: 80 mm
- Length: 2000 mm, may be cut to length
- Bar width: 5.5 mm
- Slot width: 4.5 mm

Material:

- Hard PVC
- Flame-resistant, self-extinguishing
- Temperature resistant to +60°C

Width (B) mm	P. of	Model No.
30	24 pc(s).	8800.750
40	20 pc(s).	8800.751
50	18 pc(s).	8800.755
60	18 pc(s).	8800.752
80	12 pc(s).	8800.753
100	12 pc(s).	8800.754

Colour:

- Similar to RAL 7030



Accessories:

- Metal multi-tooth screw 5.5 x 13 mm, see page 158
- Isolator cap, see page 186

1 = W 50 mm

2 = W 100 mm

3 = W 30 to 100 mm

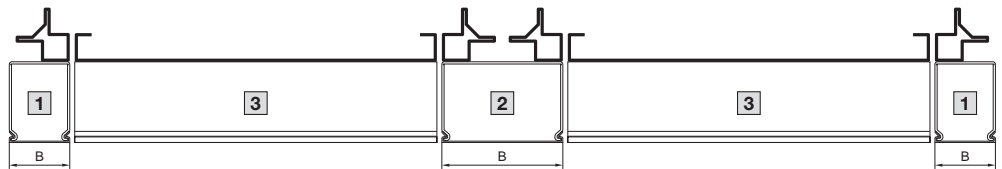

Isolator cap

for screw head

To isolate screw heads within the cable duct.

Material:

- Plastic

P. of	Model No.
100 pc(s).	8800.770

Cable management

Cable clamp rail

Right angle section

For strain relief with cable entry. Depth-variable mounting on a 25 mm pitch pattern on the horizontal enclosure section or in the base/plinth.

Material:

– Steel

Surface finish:

– Zinc-plated

Supply includes:

– Assembly parts

Enclosure width mm	P. of	Model No.
400	2 pc(s).	8619.400
600	2 pc(s).	8619.410
800	2 pc(s).	8619.420
1000	2 pc(s).	8619.430
1200	2 pc(s).	8619.440
1600	2 pc(s).	8619.450
1800	2 pc(s).	8619.460

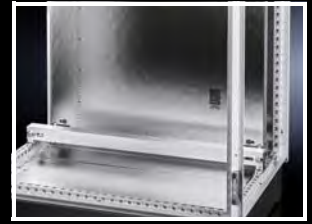

Accessories:

– Base/plinth installation bracket, see page 89

Cable clamp

for cable clamp rails

For fastening the cables to the cable clamp rails.

Material:

– Sheet steel

Surface finish:

– Zinc-plated

Supply includes:

– Plastic insert

For cable diameter mm	P. of	Model No.
6 – 12	25 pc(s).	2350.000
12 – 16	25 pc(s).	2351.000
14 – 18	25 pc(s).	2352.000
18 – 22	25 pc(s).	2353.000
22 – 26	25 pc(s).	2354.000
26 – 30	25 pc(s).	2355.000
30 – 34	25 pc(s).	2356.000
34 – 38	25 pc(s).	2357.000
38 – 42	25 pc(s).	2358.000
42 – 46	25 pc(s).	2359.000
46 – 50	25 pc(s).	2360.000



Possible alternative:

– Rail for EMC shielding bracket and strain relief, see page 166



Cable clamp rail

C-section, for mounting plates

For strain relief with cable entry. The length of the cable clamp rail is tailored to the width of the mounting plate. The mounting bracket included with the supply supports three different installation situations on the mounting plate:

- 1 Straight, at a distance of 23 mm from the mounting plate
- 2 Straight, at a distance of 10 mm from the mounting plate
- 3 Tilted towards the mounting plate

Material:

– Sheet steel

Surface finish:

– Zinc-plated

Supply includes:

– Two mounting brackets and assembly screws

For enclosure width mm	Length mm	P. of	Model No.
600	499	1 pc(s).	5001.080
800	699	1 pc(s).	5001.081
1000	899	1 pc(s).	5001.082
1200	1099	1 pc(s).	5001.083



Accessories:

– Cable clamps for C rails, see page 188

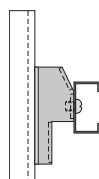

1

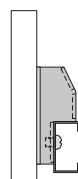

2

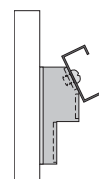

3

Cable management

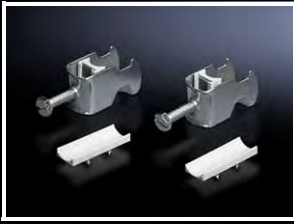

Cable clamp

for C rails

For attaching the cables to the C rails.

Material:

- Sheet steel

Surface finish:

- Zinc-plated

Supply includes:

- Plastic insert

For cable diameter mm	P. of	Model No.
6 – 14	25 pc(s).	7077.000
12 – 18	25 pc(s).	7078.000
18 – 22	25 pc(s).	7097.000
22 – 26	25 pc(s).	7097.220
26 – 30	25 pc(s).	7097.260
30 – 34	25 pc(s).	7097.300
34 – 38	25 pc(s).	7097.340
38 – 42	25 pc(s).	7098.000
42 – 56	25 pc(s).	7098.100
56 – 64	25 pc(s).	7099.000



Accessories:

- C rails, see from page 152

Cable conduit and cable conduit holder

For secure cable routing e.g. from the enclosure or mounting plate to the door. An attachment facility for standard commercially available cable ties is provided on the cable conduit holder, so that cables may be attached upon entry to/exit from the cable conduit.

Material:

- Cable conduit: Polythene
- Cable conduit holder: Polyamide

Cable conduit

Internal Ø mm	P. of	Model No.
16	25 m	2595.000
29	25 m	2589.000
36	25 m	2596.000
48	25 m	2590.000

Cable conduit holder

For cable conduit Ø mm	P. of	Model No.
16	20 pc(s).	2593.000
29	20 pc(s).	2591.000
36	20 pc(s).	2594.000
48	20 pc(s).	2592.000

Cable tie

The super-fast solution for fastening cables to the enclosure profile or mounting system parts. Simply clip into the round system punchings.

Length mm	P. of	Model No.
150	100 pc(s).	2597.000

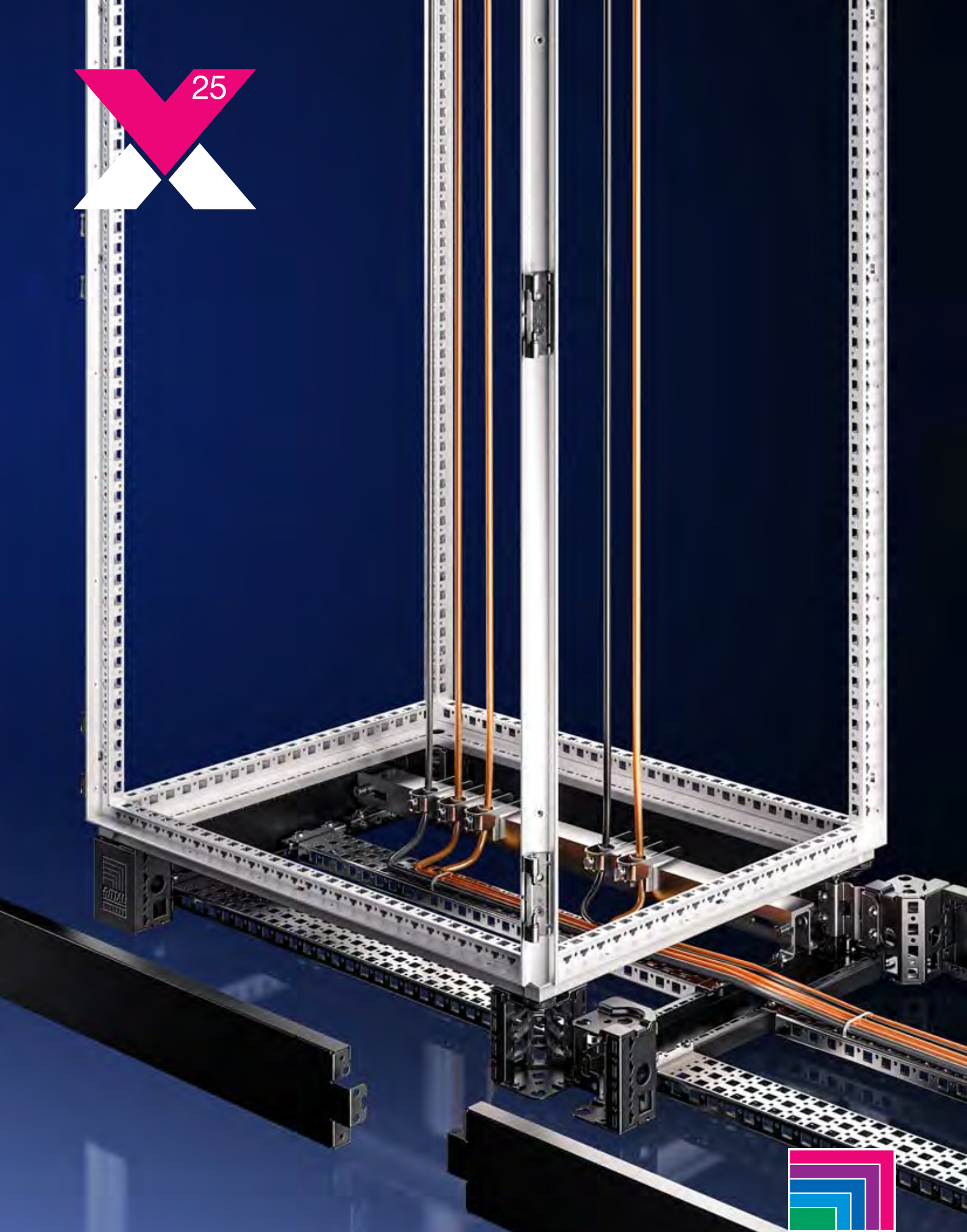

ENCLOSURES POWER DISTRIBUTION CLIMATE CONTROL IT INFRASTRUCTURE SOFTWARE & SERVICES



FRIEDHELM LOH GROUP

482.6 mm (19") installation system



Swing frame, large
The swing frame, large, supports full or partial installation for 482.6 mm (19") components. It can be adjusted as required within the 25 mm pitch pattern, and hinged on the left or right. Two swing frames may also be fitted together in 1200 mm wide enclosures. An opening angle of 180° is also supported with a special hinge.



Swing frame stay
With the swing frame stay, even enclosures with heavy installed equipment can be held securely in position during maintenance work. The stay can be fitted at the top or bottom of the enclosure.

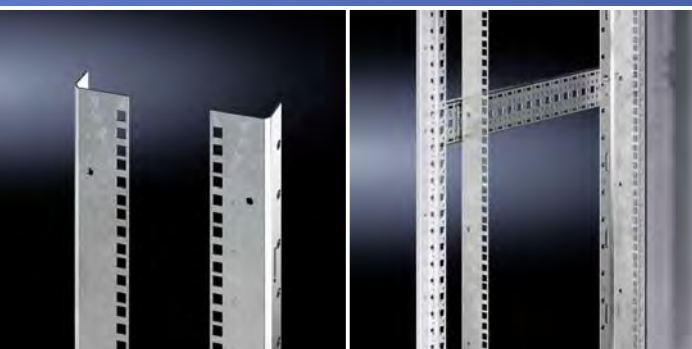

Adaptor section, 482.6 mm (19")
Turns any 600 mm wide VX25 into an electronic enclosure. The 482.6 mm (19") sections may be attached directly to the enclosure section or adjusted in the depth on a 25 mm pitch pattern on punched sections with mounting flanges. The sections may be shortened to any length for partial installation.

482.6 mm (19") installation system

Swing frame, small

The swing frame, small, is the ideal solution for partial installation with 482.6 mm (19") components. It can be positioned anywhere you like in the height and depth of the enclosure within the 25 mm pitch pattern, and is fitted in a flash.

Fastener

The 482.6 mm (19") fastener allows you to create attachment facilities for 482.6 mm (19") components in next to no time, without the need for time-consuming installation of individual cage nuts. Components are simply snap-mounted onto the 482.6 mm (19") mounting angle.



482.6 mm (19") installation system

Swing frame



Swing frame, small

for 600 and 800 mm wide enclosures

For mounting 482.6 mm (19") equipment.

Material:

– Sheet steel

Surface finish:

– Zinc-plated

Supply includes:

– Cam with double-bit lock insert and parts for attaching to the installation kit

Note:

– The swing frame stay is required to lock the open swing frame, see page 194



Accessories:

– 482.6 mm (19") fastener, 1 U, see page 196

Installation	Front, top/bottom	Set back, top/bottom	Set back/ front, centre
U	P. of	Model No.	
3	1 pc(s).	8619.500	
6	1 pc(s).	8619.510	
9	1 pc(s).	8619.520	
12	1 pc(s).	8619.530	
15	1 pc(s).	8619.540	
18	1 pc(s).	8619.550	

Also required:

[1] Installation kit	P. of	for enclosure width		Page
		600	800	
	1 pc(s).	8619.600	8619.610	192
[2] Punched section with mounting flange 23 x 64 mm, 2 or 4 pc(s). required	For enclosure depth mm			
	400	4 pc(s).	8617.110	150
	500	4 pc(s).	8617.120	150
	600	4 pc(s).	8617.130	150
	800	4 pc(s).	8617.140	150



Installation kit

for swing frame, small, and partial mounting plate

- For mounting the swing frame, small or a partial mounting plate (in conjunction with a hinge for partial mounting plates)
- Directly on the enclosure section in the foremost position
- In conjunction with punched section with mounting flange 23 x 64 mm, offset in the depth

Load capacity:

– Up to 1500 N

Material:

– Sheet steel

Surface finish:

– Nickel-plated

Supply includes:

– Assembly parts

For enclosure width mm	P. of	Model No.
600	1 pc(s).	8619.600
800	1 pc(s).	8619.610

482.6 mm (19") installation system

Swing frame

Swing frame, large

for 600, 800 and 1200 mm wide enclosures

For mounting 482.6 mm (19") equipment.

Material:

- Sheet steel

Surface finish:

- Frame: Zinc-plated
- Trim panels: Spray finished

Colour:

- Trim panels: RAL 7035

Supply includes:

- Lock system, 130° hinge and parts for attaching to the installation kit

Note:

- The swing frame stay is required to lock the open swing frame, see page 194



Accessories:

- 482.6 mm (19") fastener, 1 U, see page 196

Installation options

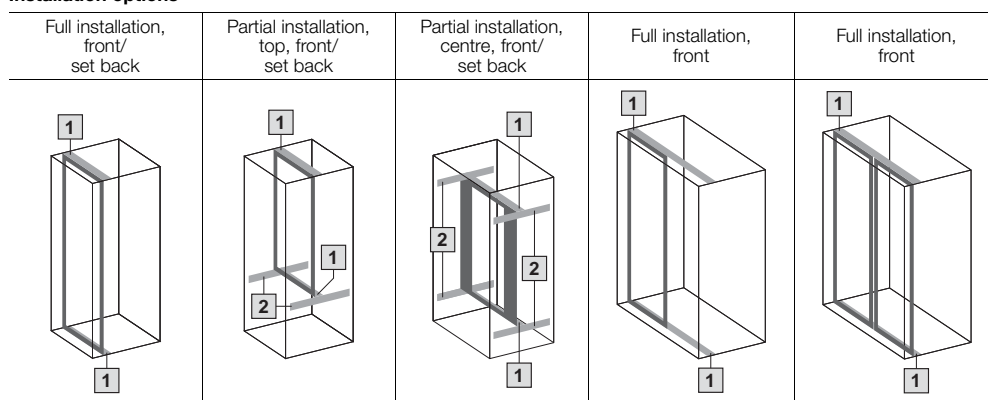

Trim panel			Without	One side	Both sides	Page
For enclosure width mm			600	800	800	
U	For min. enclosure height mm	P. of	Model No.			
22	1200	1 pc(s).	8619.010	8619.020	8619.030	
31	1600	1 pc(s).	8619.011	8619.021	-	
35	1800	1 pc(s).	8619.012	8619.022	8619.032	
40	2000	1 pc(s).	8619.013	8619.023	8619.033	
44	2200	1 pc(s).	8619.014	8619.024	8619.034	
Lock system		Cam lock	■	-	-	
		Locking rod	-	■	■	

Also required:

	For enclosure width mm	P. of				
[1] Installation kit	600	1 pc(s).	8619.040	8619.040	8619.040	194
	800	1 pc(s).	8619.041	8619.041	8619.041	194
	1200	1 pc(s).	8619.042	8619.042	8619.042	194
[2] Punched section with mounting flange 23 x 64 mm, 2 or 4 pc(s). required	Installation in enclosure depth mm					
	400	4 pc(s).	8617.110	8617.110	8617.110	150
	500	4 pc(s).	8617.120	8617.120	8617.120	150
	600	4 pc(s).	8617.130	8617.130	8617.130	150
	800	4 pc(s).	8617.140	8617.140	8617.140	150

Accessories

Ergoform-S lock systems			-	see page 123	see page 123	
Lock inserts	Type A		-	see page 123	see page 123	
	Type D	1 pc(s).	2484.000	-	-	
180° hinge		1 pc(s).	-	8619.050	8619.050	194



482.6 mm (19") installation system

Swing frame



Installation kit

for swing frame, large

For mounting:

- Directly on the enclosure section when installed across the entire enclosure height
- In conjunction with punched section with mounting flange 23 x 64 mm, for partial installation in the enclosure height

Material:

- Sheet steel, 3 mm

Surface finish:

- Nickel-plated

Supply includes:

- Assembly parts

For enclosure width mm	Load capacity N	P. of	Model No.
600	3500	1 pc(s).	8619.040
800	3500	1 pc(s).	8619.041
1200	1500	1 pc(s).	8619.042



Swing frame stay

Secures the swing frame in the open position.

For mounting on swing frame, large:

- 8619.270 at the top of the enclosure
- 1980.200 at the bottom of the enclosure (with safety stop at 160°)

	P. of	Model No.
For 130° hinge	1 pc(s).	8619.270
For 180° hinge	1 pc(s).	1980.200



For mounting on swing frame, small:

- 8619.270, may be mounted at the top or bottom on the installation kit



180° hinge

for swing frame, large

- To extend the opening angle from 130° to 180° in the foremost installation position
- Provides optimum access to the components and 482.6 mm (19") components located behind the swing frame

Load capacity:

- Up to 1500 N

Material:

- Die-cast

P. of	Model No.
1 pc(s).	8619.050



Slide rail

for swing frames

To support heavy slide-in 482.6 mm (19") electronic equipment in the swing frame.

Material:

- Sheet steel

Surface finish:

- Zinc-plated

For slide-in equipment with max. installation depth	P. of	Model No.
< 190 mm	10 pc(s).	1962.200
> 190 mm	10 pc(s).	1963.200

482.6 mm (19") installation system

Mounting angles

Adaptor section, 482.6 mm (19")

For mounting electronic components, subracks and other 482.6 mm (19") equipment. Adaptor sections are easily shortened for partial assemblies. Depth-offset installation in 600 mm wide enclosures is possible using punched sections with mounting flanges, 18 x 64 mm.

Material:

- Sheet steel, 2.5 mm

Supply includes:

- Assembly parts

Note:

- The 482.6 mm (19") measurement is obtained when mounting on the frame for 600 mm wide enclosures.

For enclosure height mm	U	P. of	Model No.
1600	33	2 pc(s).	8619.300¹⁾
1800	38	2 pc(s).	8619.310
2000	42	2 pc(s).	8619.320¹⁾

¹⁾ For the rear of electronic enclosures, see page 66



Accessories:

- 482.6 mm (19") fastener, 1 U, see page 196
- Assembly screws, see page 158
- Slide rail with attachment on one side, see page 196
- Slide rail with attachment on both sides, see page 196

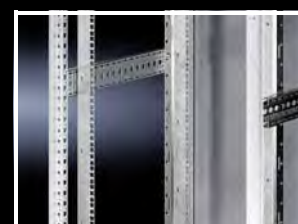

Adaptor piece, 482.6 mm (19")

The 1 U sub-section of adaptor sections. For the installation of subracks and other 482.6 mm (19") equipment. Depth-offset installation in 600 mm wide enclosures is possible using punched sections with mounting flanges, 18 x 64 mm.

Material:

- Sheet steel, 2.5 mm

Supply includes:

- Assembly parts

Note:

- The 482.6 mm (19") measurement is obtained when mounting on the frame for 600 mm wide enclosures.

U	P. of	Model No.
1	4 pc(s).	8619.330



Accessories:

- 482.6 mm (19") fastener, 1 U, see page 196
- Assembly screws, see page 158



482.6 mm (19") installation system

Slide rails/482.6 mm (19") installation



Slide rail

for adaptor section 482.6 mm (19") with attachment on both sides

Mounting between the 482.6 mm (19") front and rear adaptor sections or 482.6 mm (19") adaptor pieces.

Material:

- Sheet steel

Surface finish:

- Zinc-plated

Supply includes:

- Assembly parts

For enclosure depth mm	P. of	Model No.
500	10 pc(s).	8613.150
600	10 pc(s).	8613.160
800	10 pc(s).	8613.180



Slide rail

for adaptor section 482.6 mm (19") with attachment on one side

Mounting on the adaptor section, 482.6 mm (19").

Material:

- Sheet steel

Surface finish:

- Zinc-plated

Supply includes:

- Assembly parts

Length mm	P. of	Model No.
270	10 pc(s).	4531.000



482.6 mm (19") fastener, 1 U with contact

For simple screw connection of installation components within the 482.6 mm (19") mounting level. Simply slide onto the mounting angle from the inside and lock home.

Benefits:

- Fast positioning and installation instead of using individual cage nuts
- Integral contacting for potential equalisation
- Preconfigured 1 U support with 3 cage nuts, including centre attachment to standard EIA 310
- Supports multiple dismantling and reuse

Material:

- Sheet steel, zinc-plated

Thread	P. of	Model No.
M5	24 pc(s).	2090.000



Also required:

- Multi-tooth screws 7094.130, see page 196

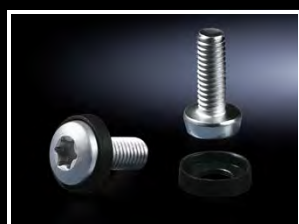

Multi-tooth screws

M5 x 16 mm

For optimum transmission of torques, an extended tool life, and enhanced safety and reliability when tightening and loosening screw connections.

Supply includes:

- 50 plastic washers
- 50 assembly screws

	Bit size	P. of	Model No.
M5	Multi-tooth 25	50 pc(s).	7094.130

The 3-phase coating procedure

Coating procedure	Technical properties	Technical specifications	
Degreasing, nanoceramic pretreatment, rinsing	Used as corrosion protection and to improve paint adhesion.	Nanoceramic conversion layer	
Interior/exterior: Anodic dipcoat priming	Even layer formation on all surfaces, edges and in cavities, which produces a high level of corrosion protection even at the assembly stage. The primer is readily overpainted and free from heavy metals, chromate and silicone.	Erichsen cupping test to DIN EN ISO 1520	≥ 4 mm
		Buchholz hardness to DIN EN ISO 2815	≥ 80
		Cross cutting to DIN EN ISO 2409	Gt 0
Stove enamelling			
Exterior: Textured powder coating	Powder-coating is distinguished by a high level of mechanical resistance, excellent corrosion protection, good resistance to chemicals and temperature, and its facility for decontamination. The powder coating is readily overpainted and is free from heavy metals, chromate and silicone.	Erichsen cupping test to DIN EN ISO 1520	≥ 3.5 mm
		Buchholz hardness to DIN EN ISO 2815	≥ 80
		Cross cutting to DIN EN ISO 2409	Gt 0
		Salt spray test to DIN EN ISO 9227 NSS	Test period: 168 hrs
		Condensate test to DIN EN ISO 6270-2 CH	Test period: 500 hrs
		Condensate test to DIN EN ISO 6270-2 AHT	Test period: 20 cycles
Stove enamelling			

The coating is resistant to:

- Mineral oils
- Lubricants
- Machine emulsions
- Alcohol-based solvents (briefly, e.g. during cleaning)
- Weak acids and alkalines

Suitability for overpainting of the primer or powder coating

After careful cleaning of the surface, the standard coating may be overpainted with

- DD gloss paints
- Single and dual-component gloss paints
- Car repair paints
- Powder paints
- Water-based paints

If in doubt, perform a compatibility test. Always follow the paint manufacturer's instructions. When overpainting, take care not to exceed 180°C and a baking time of 15 minutes.

Outdoor use of enclosures

In order to guarantee satisfactory long-term function of enclosures in outdoor use, the relevant environmental factors must be taken into account.

These include:

- UV radiation, the corrosive action of air pollution, rain, icing, snow, wind or other factors in special climatic conditions.

Condensation inside the enclosure

Condensation must be prevented by means of appropriate measures, e.g. by venting or heating the enclosure.

Protection category

The enclosure may be exposed to extreme weather conditions during outdoor use. Long periods of rain, snow, ice, high winds and temperature fluctuations place particularly high demands on the enclosure sealing. The protection category IP X3 as envisaged for external weather conditions in DIN VDE 0100, part 737, point 5.2 is often insufficient to provide permanent protection for electrical equipment.

Protection categories to IEC 60 529 (EN 60 529)

The IP protection category is characterised by 2 numerals.

Example of a protection category, e.g. IP 43:

Code letters

IP

First numeral

4

Second numeral

3

Degrees of protection for protection against contact and foreign bodies: First numeral			Degrees of protection for protection against water: Second numeral		
First numeral	Degree of protection		Second numeral	Degree of protection	
	Description	Explanation		Description	Explanation
1	Protected against solid foreign objects with a diameter of 50 mm and greater	The object probe, a sphere 50 mm in diameter, must not penetrate fully. ¹⁾	1	Protected against vertically falling water drops	Vertically falling drops shall have no harmful effects.
2	Protected against solid foreign objects with a diameter of 12.5 mm and greater	The object probe, a sphere 12.5 mm in diameter, must not penetrate fully. ¹⁾ The articulated test finger may penetrate up to its length of 80 mm, but adequate distance from hazardous parts must be adhered to.	2	Protected against vertically falling water drops when the enclosure is tilted up to 15°	Vertically falling drops shall not have any harmful effects when the enclosure is tilted up to 15° on either side of the vertical.
3	Protected against solid foreign objects with a diameter of 2.5 mm and greater	The object probe, a sphere 2.5 mm in diameter, must not penetrate at all ¹⁾ .	3	Protected against sprayed water	Water sprayed at an angle of up to 60° on either side of the vertical shall have no harmful effects.
4	Protected against solid foreign objects with a diameter of 1.0 mm and greater	The object probe, a sphere 1.0 mm in diameter, must not penetrate at all ¹⁾ .	4	Protected against splashed water	Water splashed on the enclosure from any direction shall have no harmful effects.
5	Dust-protected	The ingress of dust is not fully prevented, but dust shall not enter to such an extent as to impair satisfactory operation of the device or safety.	5	Protected against water jets	Water directed at the enclosure from any direction in a jet shall have no harmful effects.
6	Dust-tight	No ingress of dust at a partial vacuum of 20 mbar inside the enclosure.	6	Protected against powerful water jets	Water directed at the enclosure from every direction in a powerful jet shall have no harmful effects.
			7	Protected against temporary immersion in water	Water must not ingress to such an extent as to cause harmful effects when the enclosure is temporarily immersed in water under standardised pressure and time conditions.
			8	Protected against continuous immersion in water	Ingress of water in quantities causing harmful effects shall not be possible when the enclosure is continuously immersed in water under conditions to be agreed between the manufacturer and the user. However, the conditions must be more difficult than for numeral 7.
			9	Protected against high-pressure and high-temperature water jets	Water projected at high pressure and high temperature against the enclosure from any direction shall not have harmful effects.

¹⁾ The full diameter of the object probe must not pass through an opening of the enclosure.

NEMA

The **N**ational **E**lectrical **M**anufacturers **A**ssociation (NEMA) is a standards organisation in Washington, USA, which publishes a number of technical standards but does not test or certify products itself.

The following NEMA classification outlines the protection of individuals from accidental contact with equipment and the protection of an enclosure from external factors.

Further information on protection categories may be found on the Internet at: www.rittal.com

UL/NEMA Type	Intended use and description
1	Enclosures for use predominantly indoors Protection against the penetration of foreign bodies
3	Enclosures for use predominantly outdoors Protection from rain, hail, dust, icing and the damage caused by icing
3R	Enclosures for use predominantly outdoors Protection from rain, hail, icing and the damage caused by icing
3S	Enclosures for use predominantly outdoors Protection from rain, hail and dust External mechanisms remain usable despite being coated in ice
4	Enclosures for indoor or outdoor use Protection against rain, foreign bodies, splashed water and hosed water and against damage caused by icing on the exterior of the enclosure
4X	Enclosures for indoor or outdoor use Protection against rain, foreign bodies, splashed water and hosed water and against damage caused by icing on the exterior of the enclosure Increased protection from corrosion
12, 12K	Enclosures for use predominantly indoors Protection against dust deposits, foreign bodies and non-corrosive dripping liquids
13	Enclosures for use predominantly indoors Protection against dust deposits, sprayed water, oil, and non-corrosive refrigerants

The UL/NEMA classifications are not directly comparable with IP protection categories, since both the test conditions and the evaluation of the test results are different

Approvals and permits

Product certifications and approvals are pivotal to the global acceptance of industrial products. Rittal products meet the highest internationally recognised quality yardsticks. All components are subjected to the most stringent testing in accordance with international standards and regulations. The consistently high product quality is ensured by a comprehensive quality management system. Regular production inspections by external test institutes also guarantee compliance with global standards

A precise allocation of products to marks of conformity can be found on our product and service pages on the Internet. www.rittal.com

PE conductor connection

The PE conductor connection must be designed by the manufacturer of switchgear in accordance with the relevant VDE and/or local regulations. The enclosure packs generally contain earthing materials (screws, nuts, washers). The assembly instructions contain recommendations on installing a PE conductor. The pre-assembled earth straps, available as accessories in various cross-sections and lengths, are intended to make assembly of a PE conductor easier.

Further information can be found in our technical documentation "PE conductor connection, current carrying capacity".

Baying enclosure system VX25

Technical details

Basic enclosure

Sheet steel, stainless steel

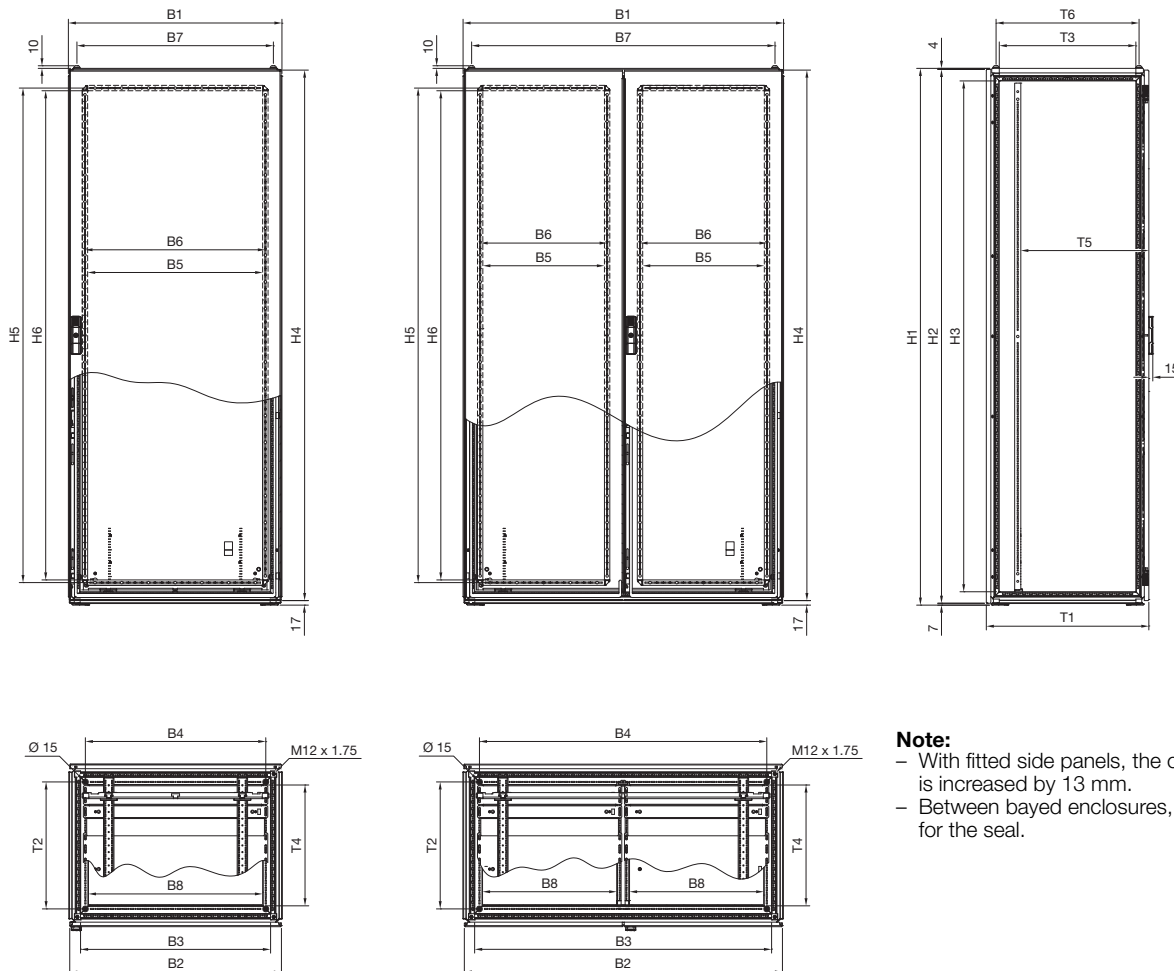

Note:

- With fitted side panels, the overall width (B1) is increased by 13 mm.
- Between bayed enclosures, allow 1 mm for the seal.

Two-door

Model No.		Width dimensions mm								Height dimensions mm						Depth dimensions mm						Mounting plate	
Spray-finished	Stainless steel	B1	B2	B3	B4	B5	B6	B7	B8	H1	H2	H3	H4	H5	H6	T1	T2	T3	T4	T5	T6	F	G
8004.000	-	999	992	911	875	355	375	935	402	2008	1997	1911	1985	1850	1830	408	275	311	252	132 - 357	335	899	1896
8005.000	-	999	992	911	875	355	375	935	402	2008	1997	1911	1985	1850	1830	508	375	411	352	132 - 457	435	899	1896
8006.000	-	999	992	911	875	355	375	935	402	2008	1997	1911	1985	1850	1830	608	475	511	452	132 - 557	535	899	1896
8080.000	-	999	992	911	875	355	375	935	402	1808	1797	1711	1785	1650	1630	408	275	311	252	132 - 357	335	899	1696
8204.000	-	1199	1192	1111	1075	455	475	1135	502	2008	1997	1911	1985	1850	1830	408	275	311	252	132 - 357	335	1099	1896
8205.000	-	1199	1192	1111	1075	455	475	1135	502	2008	1997	1911	1985	1850	1830	508	375	411	352	132 - 457	435	1099	1896
8206.000	8451.000	1199	1192	1111	1075	455	475	1135	502	2008	1997	1911	1985	1850	1830	608	475	511	452	132 - 557	535	1099	1896
8208.000	-	1199	1192	1111	1075	455	475	1135	502	2008	1997	1911	1985	1850	1830	808	675	711	652	132 - 757	735	1099	1896
8215.000	-	1199	1192	1111	1075	455	475	1135	502	1208	1197	1111	1185	1050	1030	508	375	411	352	132 - 457	435	1099	1096
8226.000	-	1199	1192	1111	1075	455	475	1135	502	2208	2197	2111	2185	2050	2030	608	475	511	452	132 - 557	535	1099	2096
8245.000	-	1199	1192	1111	1075	455	475	1135	502	1408	1397	1311	1385	1250	1230	508	375	411	352	132 - 457	435	1099	1296
8265.000	-	1199	1192	1111	1075	455	475	1135	502	1608	1597	1511	1585	1450	1430	508	375	411	352	132 - 457	435	1099	1496
8284.000	8456.000	1199	1192	1111	1075	455	475	1135	502	1808	1797	1711	1785	1650	1630	408	275	311	252	132 - 357	335	1099	1696
8285.000	8453.000	1199	1192	1111	1075	455	475	1135	502	1808	1797	1711	1785	1650	1630	508	375	411	352	132 - 457	435	1099	1696
8286.000	-	1199	1192	1111	1075	455	475	1135	502	1808	1797	1711	1785	1650	1630	608	475	511	452	132 - 557	535	1099	1696
8880.000	-	799	792	711	675	255	275	735	652	1808	1797	1711	1785	1650	1630	508	375	411	352	132 - 457	435	699	1696
8881.000	-	799	792	711	675	255	275	735	652	1808	1797	1711	1785	1650	1630	608	475	511	452	132 - 557	535	699	1696

Baying enclosure system VX25

Technical details

Basic enclosure

Sheet steel, stainless steel

Mounting plate

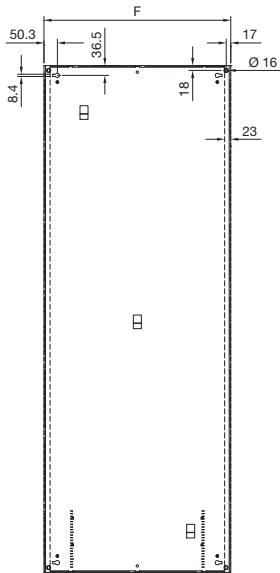

Profile

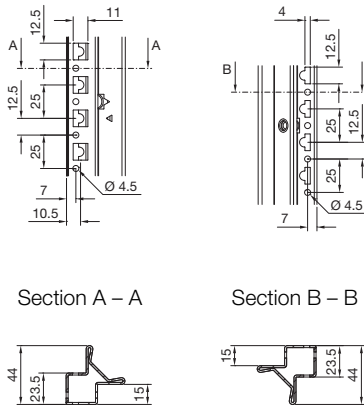

Enclosure

- B1 = Overall width
- B2 = Width of door
- B3 = Clearance of enclosure frame
- B4 = Hole distance, base/plinth attachment
- B5 = Clearance of tubular door frame
- B6 = Distance between axes of the tubular door frame rows of holes
- B7 = Roof attachment spacing
- B8 = Clearance opening, base
- H1 = Overall height
- H2 = Height of rear panel
- H3 = Clearance of enclosure frame
- H4 = Height of door
- H5 = Distance between axes of the tubular door frame rows of holes
- H6 = Clearance of tubular door frame
- T1 = Overall depth
- T2 = Hole distance, base/plinth attachment
- T3 = Clearance of enclosure frame
- T4 = Clearance opening, base
- T5 = Possible mounting depth (mounting plate assembly), depth-adjustable on a 25 mm pattern
- T6 = Roof attachment spacing

Mounting plate

- F = Overall width
- G = Overall height

Single-door

Model No.		Width dimensions mm								Height dimensions mm						Depth dimensions mm						Mounting plate	
Spray-finished	Stainless steel	B1	B2	B3	B4	B5	B6	B7	B8	H1	H2	H3	H4	H5	H6	T1	T2	T3	T4	T5	T6	F	G
8084.000	-	999	992	911	875	855	875	935	402	1808	1797	1711	1785	1650	1630	408	275	311	252	132 - 357	335	899	1696
8405.000	-	399	392	311	275	255	275	335	252	2008	1997	1911	1985	1850	1830	508	375	411	352	132 - 457	435	299	1896
8406.000	-	399	392	311	275	255	275	335	252	2008	1997	1911	1985	1850	1830	608	475	511	452	132 - 557	535	299	1896
8485.000	-	399	392	311	275	255	275	335	252	1808	1797	1711	1785	1650	1630	508	375	411	352	132 - 457	435	299	1696
8486.000	-	399	392	311	275	255	275	335	252	1808	1797	1711	1785	1650	1630	608	475	511	452	132 - 557	535	299	1696
8604.000	-	599	592	511	475	455	475	535	452	2008	1997	1911	1985	1850	1830	408	275	311	252	132 - 357	335	499	1896
8605.000	-	599	592	511	475	455	475	535	452	2008	1997	1911	1985	1850	1830	508	375	411	352	132 - 457	435	499	1896
8606.000	8452.000	599	592	511	475	455	475	535	452	2008	1997	1911	1985	1850	1830	608	475	511	452	132 - 557	535	499	1896
8608.000	-	599	592	511	475	455	475	535	452	2008	1997	1911	1985	1850	1830	808	675	711	652	132 - 757	735	499	1896
8615.000	-	599	592	511	475	455	475	535	452	1208	1197	1111	1185	1050	1030	508	375	411	352	132 - 457	435	499	1096
8626.000	-	599	592	511	475	455	475	535	452	2208	2197	2111	2185	2050	2030	608	475	511	452	132 - 557	535	499	2096
8645.000	-	599	592	511	475	455	475	535	452	1408	1397	1311	1385	1250	1230	508	375	411	352	132 - 457	435	499	1296
8665.000	-	599	592	511	475	455	475	535	452	1608	1597	1511	1585	1450	1430	508	375	411	352	132 - 457	435	499	1496
8684.000	-	599	592	511	475	455	475	535	452	1808	1797	1711	1785	1650	1630	408	275	311	252	132 - 357	335	499	1696
8685.000	8457.000	599	592	511	475	455	475	535	452	1808	1797	1711	1785	1650	1630	508	375	411	352	132 - 457	435	499	1696
8686.000	-	599	592	511	475	455	475	535	452	1808	1797	1711	1785	1650	1630	608	475	511	452	132 - 557	535	499	1696
8804.000	-	799	792	711	675	655	675	735	652	2008	1997	1911	1985	1850	1830	408	275	311	252	132 - 357	335	699	1896
8805.000	-	799	792	711	675	655	675	735	652	2008	1997	1911	1985	1850	1830	508	375	411	352	132 - 457	435	699	1896
8806.000	8450.000	799	792	711	675	655	675	735	652	2008	1997	1911	1985	1850	1830	608	475	511	452	132 - 557	535	699	1896
8808.000	-	799	792	711	675	655	675	735	652	2008	1997	1911	1985	1850	1830	808	675	711	652	132 - 757	735	699	1896
8815.000	-	799	792	711	675	655	675	735	652	1208	1197	1111	1185	1050	1030	508	375	411	352	132 - 457	435	699	1096
8826.000	-	799	792	711	675	655	675	735	652	2208	2197	2111	2185	2050	2030	608	475	511	452	132 - 557	535	699	2096
8845.000	-	799	792	711	675	655	675	735	652	1408	1397	1311	1385	1250	1230	508	375	411	352	132 - 457	435	699	1296
8865.000	-	799	792	711	675	655	675	735	652	1608	1597	1511	1585	1450	1430	508	375	411	352	132 - 457	435	699	1496
8884.000	8454.000	799	792	711	675	655	675	735	652	1808	1797	1711	1785	1650	1630	408	275	311	252	132 - 357	335	699	1696
8885.000	8455.000	799	792	711	675	655	675	735	652	1808	1797	1711	1785	1650	1630	508	375	411	352	132 - 457	435	699	1696
8886.000	-	799	792	711	675	655	675	735	652	1808	1797	1711	1785	1650	1630	608	475	511	452	132 - 557	535	699	1696

Baying enclosure system VX25

Technical details

Electronic enclosure

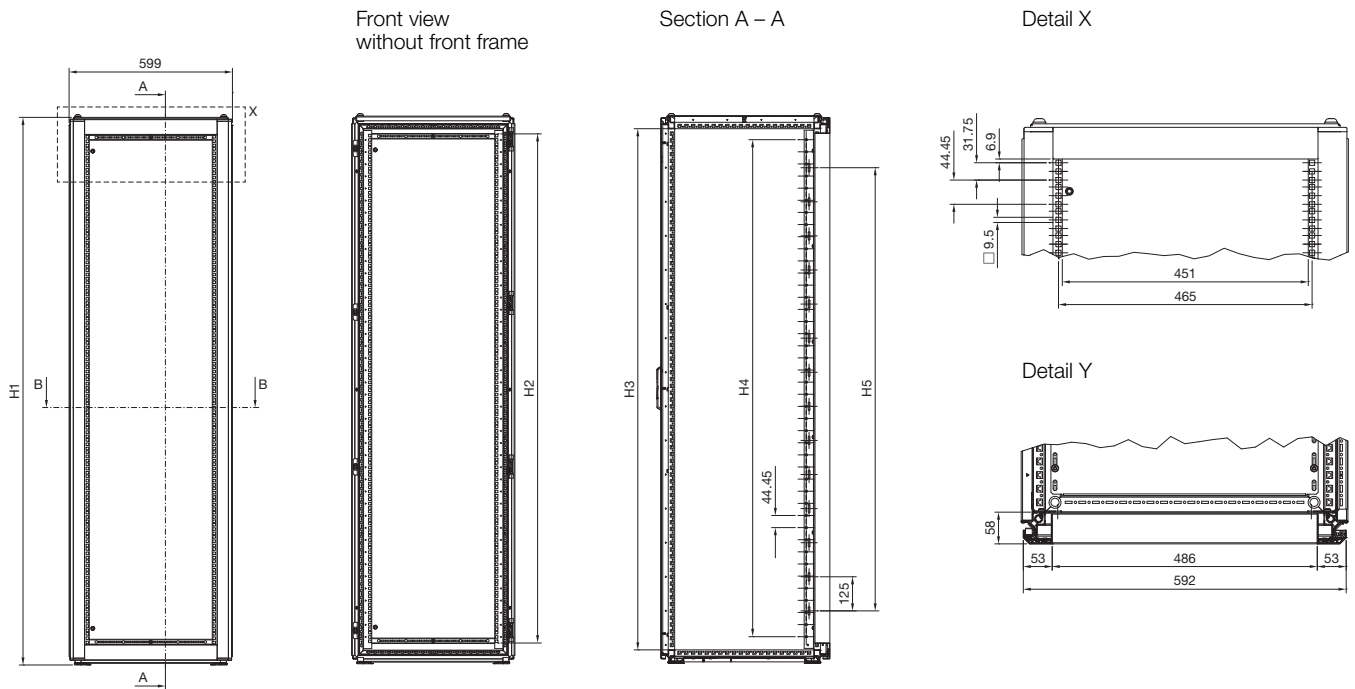

Section B - B

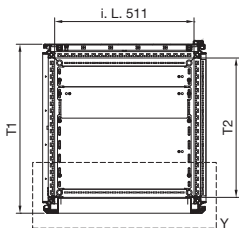

Model No.	Height dimensions						Depth dimensions		
	H1 mm	H2		H3 mm	H4		H5 mm	T1 mm	T2 mm
		mm	U		mm	U			
8410.000	1608	1466.6	33	c.w. 1511	1422.4	32	1375	619.5	c.w. 511
8418.000	1608	1466.6	33	c.w. 1511	1422.4	32	1375	619.5	c.w. 511
8430.000	2008	1866.9	42	c.w. 1911	1822.45	41	1625	819.5	c.w. 711
8438.000	2008	1866.9	42	c.w. 1911	1822.45	41	1625	819.5	c.w. 711

i.L. = clearance width (c.w.)

Distribution enclosure

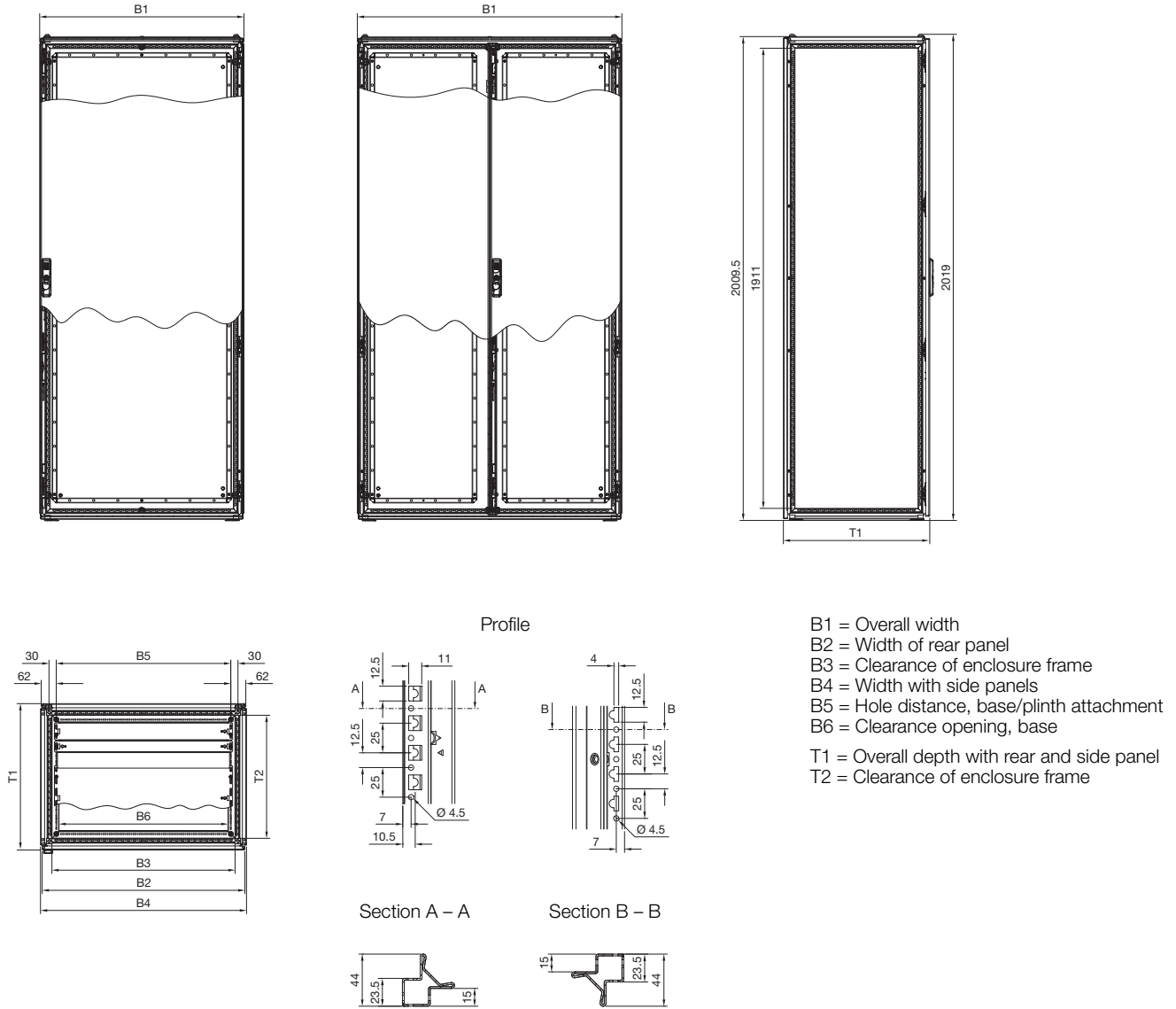

Model No.	Width dimensions mm						Depth dimensions mm	
	B1	B2	B3	B4	B5	B6	T1	T2
9666.916	849	842	761	856	725	702	608	511
9666.926	1099	1092	1011	1106	975	952	608	511
9666.956	849	842	761	856	725	702	408	311
9666.966	1099	1092	1011	1106	975	952	408	311

Baying enclosure system VX25

Technical details

Modular enclosure

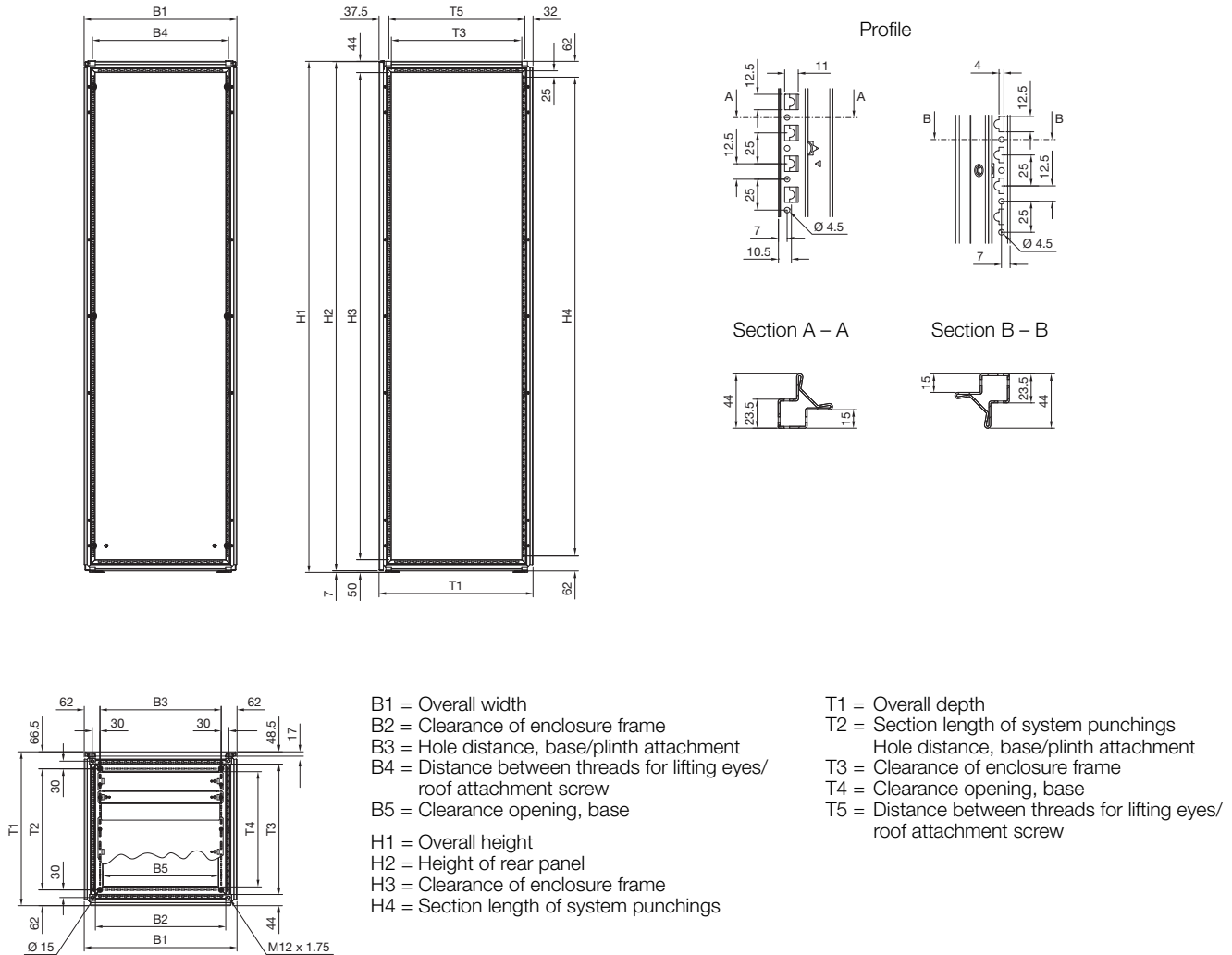

Model No.	Width dimensions mm					Height dimensions mm				Depth dimensions mm				
	B1	B2	B3	B4	B5	H1	H2	H3	H4	T1	T2	T3	T4	T5
9680.406	399	311	375	335	252	2005	1997	1911	1875	603.5	575	511	452	535
9680.408	399	311	375	335	252	2005	1997	1911	1875	803.5	775	711	652	735
9680.426	399	311	375	335	252	2205	2197	2111	2075	603.5	575	511	452	535
9680.428	399	311	375	335	252	2205	2197	2111	2075	803.5	775	711	652	735
9680.606	599	511	575	535	452	2005	1997	1911	1875	603.5	575	511	452	535
9680.608	599	511	575	535	452	2005	1997	1911	1875	803.5	775	711	652	735
9680.626	599	511	575	535	452	2205	2197	2111	2075	603.5	575	511	452	535
9680.628	599	511	575	535	452	2205	2197	2111	2075	803.5	775	711	652	735
9680.806	799	711	775	735	652	2005	1997	1911	1875	603.5	575	511	452	535
9680.808	799	711	775	735	652	2005	1997	1911	1875	803.5	775	711	652	735
9680.826	799	711	775	735	652	2205	2197	2111	2075	603.5	575	511	452	535
9680.828	799	711	775	735	652	2205	2197	2111	2075	803.5	775	711	652	735

Base/plinth system VX

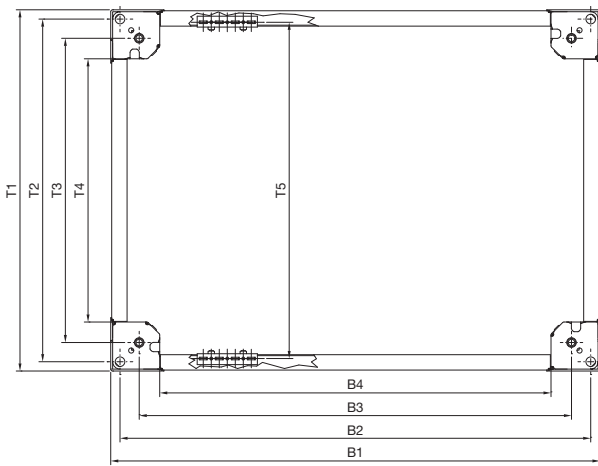

View A

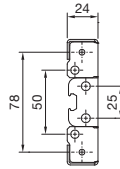

View B

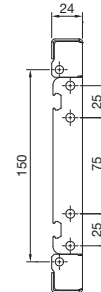

Base/plinth, 100 mm high

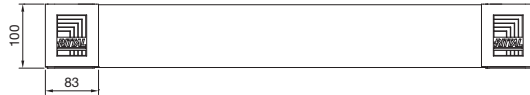

Base/plinth, 200 mm high

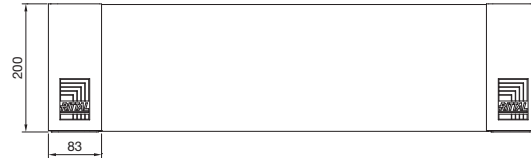

Base/plinth trim panels, solid, 100 mm high, front view

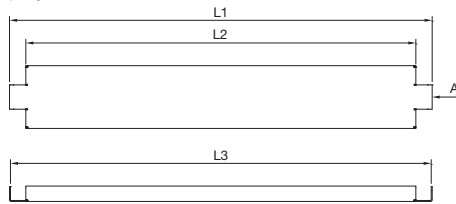

Base/plinth trim panels, solid, 200 mm high, front view

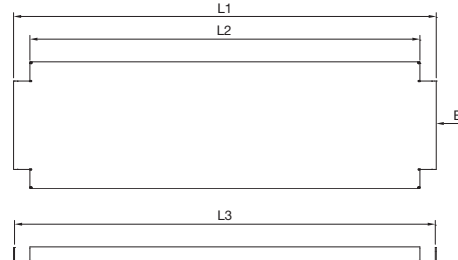

Rear view



Rear view



Base/plinth trim panels with brush strip, 100 mm high, front view

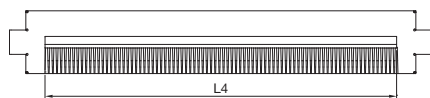

Base/plinth trim panels, vented, 100 mm high, front view



For enclosure width or depth mm	Width dimensions mm				Length dimensions mm				Depth dimensions mm				
	B1	B2	B3	B4	L1	L2	L3	L4	T1	T2	T3	T4	T5 ¹⁾
300	264	235	175	111	160	109	157	-	264	235	175	111	225
400	364	335	275	211	260	209	257	-	364	335	275	211	325
500	464	435	375	311	360	309	357	-	464	435	375	311	425
600	564	535	475	411	460	409	457	349	564	535	475	411	525
800	764	735	675	611	660	609	657	549	764	735	675	611	725
850	814	785	725	661	710	659	707	-	-	-	-	-	775
1000	964	935	875	811	860	809	857	-	964	935	875	811	925
1100	1064	1035	975	911	960	909	957	-	-	-	-	-	1025
1200	1164	1135	1075	1011	1060	1009	1057	-	1164	1135	1075	1011	1125
1600	1564	1535	1475	1411	1460	1409	1457	-	-	-	-	-	1525
1800	1764	1735	1675	1611	1660	1609	1657	-	-	-	-	-	1725

¹⁾ T5 = Distance between system punchings including base/plinth installation bracket

Baying enclosure system VX25

Technical details

Swing frame, small

For 600 mm wide enclosures

For 800 mm wide enclosures optionally at the side or in the centre

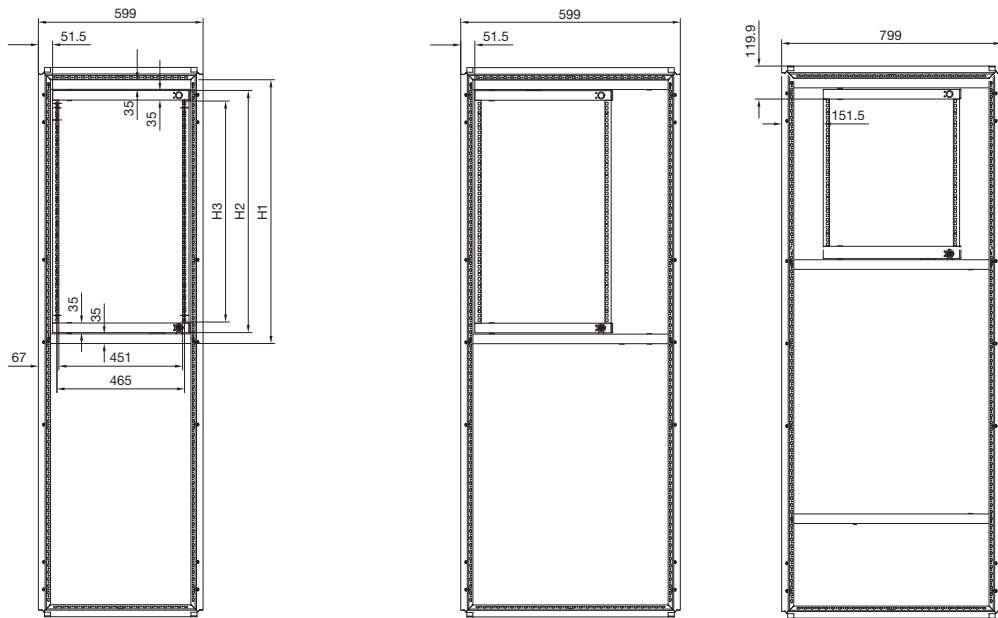

Height units	3 U	6 U	9 U	12 U	15 U	18 U
Model No. SR	8619.500	8619.510	8619.520	8619.530	8619.540	8619.550
H1 mm	285	435	560	685	835	960
H2 mm	206	356	481	606	756	881
H3 mm	136	286	411	536	686	811

Installation depth T max. = mm with dimension D¹⁾ of at least 45 mm

Enclosure width mm	600	800	800
Internal mounting	Centre	Side	Centre
Enclosure depth mm	1 T max. 400 185 500 185 ≥ 600 185	1 T max. 310 410 500	1 T max. 310 370 370

¹⁾ D = Distance from inner edge of door to front edge of swing frame, may be installed deeper on a 25 mm pitch pattern

Swing frame, small

VX25 installation examples

Partial installation

in 600 and 800 mm wide enclosures, each in the highest or lowest position.

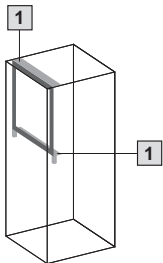

Front

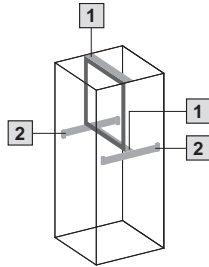

Set back

Partial installation, centre

in 600 and 800 mm wide enclosures.

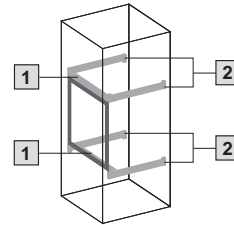

Front

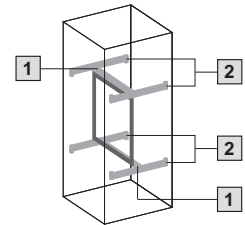

Set back

Side installation

With an enclosure depth of 600 or 800 mm, side installation of a small swing frame is identical to installation parallel to the front.

For access to the swing frame, we recommend hinges for the side panel.

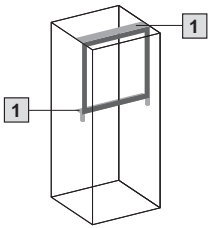

1 Installation kit for swing frame, small

2 Punched section with mounting flange, 23 x 64 mm

Baying enclosure system VX25

Technical details

Swing frame, large Without trim panel

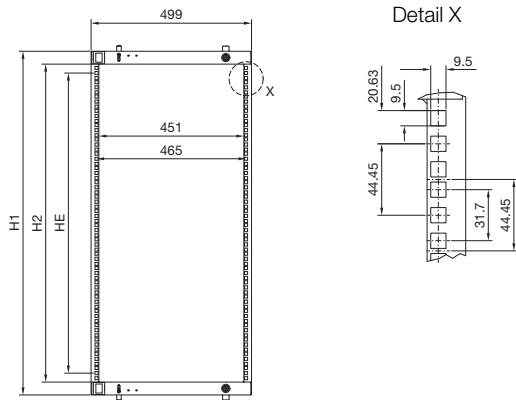

Height units	22 U	31 U	35 U	40 U	44 U
Model No. SR	8619.010	8619.011	8619.012	8619.013	8619.014
for enclosure height mm (or higher)	1200	1600	1800	2000	2200
H1 mm	1068	1468	1668	1868	2068
H2 mm	988	1388	1588	1788	1988
Depth mm	80	80	80	80	80

Installation depth T max. = mm with dimension D¹⁾ of at least 48 mm

Enclosure width mm	600	1200	1200
Internal mounting	Centre	Left or right	Left and right
Enclosure depth mm	1 T max.	1 T max.	1 T max.
400	210	295	295
500	210	395	360
600	210	495	360
800	210	695	360

¹⁾D = Distance from inner edge of door to front edge of swing frame, may be installed deeper on a 25 mm pitch pattern

Swing frame, large

Without trim panel, VX25 installation examples

Full installation

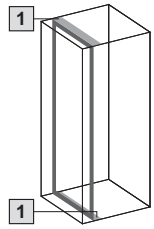

600 mm front

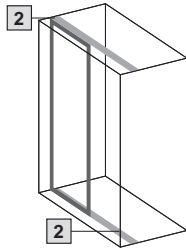

1200 mm front

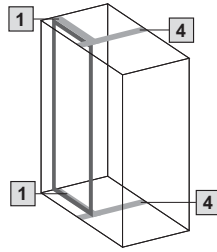

1200 mm front with system divider

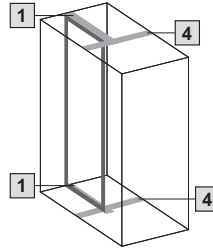

1200 mm set back with system divider

Side installation

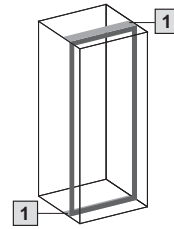

With an enclosure depth of 600 mm, side installation of a large swing frame is identical to installation parallel to the front. For access to the swing frame, we recommend hinges for the side panel.

Partial installation, top

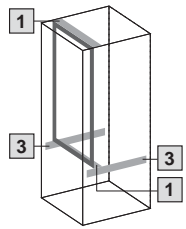

600 mm front

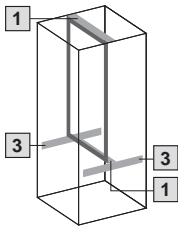

600 mm set back

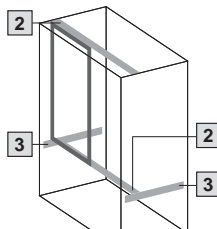

1200 mm front

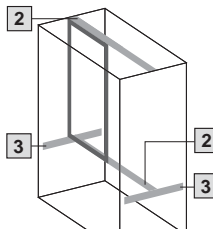

1200 mm set back

- 1 Installation kit for 600 mm wide enclosures
- 2 Installation kit for 1200 mm wide enclosures
- 3 Punched section with mounting flange, 23 x 64 mm
- 4 System divider

Partial installation, centre

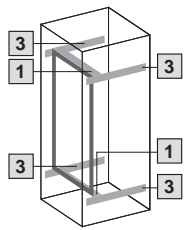

600 mm front

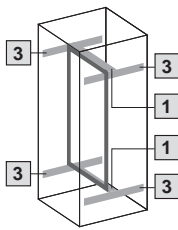

600 mm set back

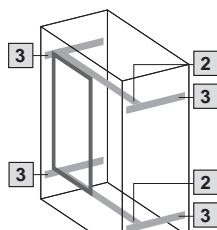

1200 mm front

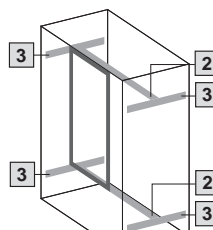

1200 mm set back

Baying enclosure system VX25

Technical details

Swing frame, large

With trim panel

Mounting components, sides
(built into VX25)

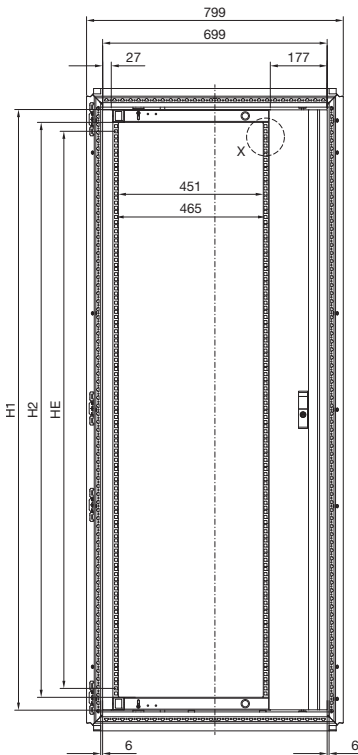

Mounting components, centre
(built into VX25)

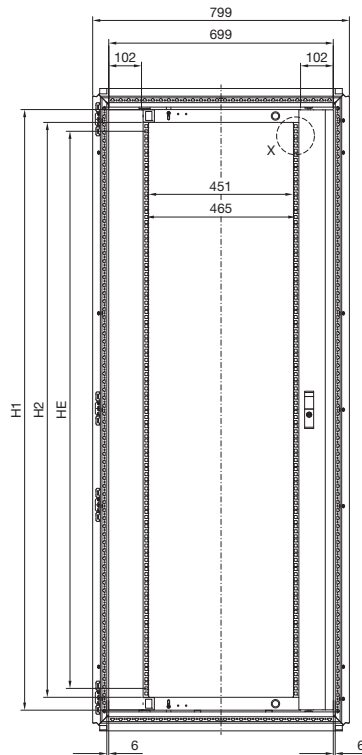

Detail X

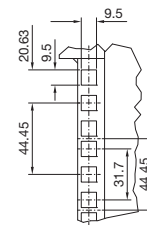

Height units	22 U		31 U		35 U		40 U		44 U		
	Side	Centre	Side	Centre	Side	Centre	Side	Centre	Side	Centre	
Trim panel											
Model No. SR	RAL 7035	8619.020	8619.030	8619.021	-	8619.022	8619.032	8619.023	8619.033	8619.024	8619.034
For enclosure height mm (or higher)		1200		1600		1800		2000		2200	
H1 mm		1068		1468		1668		1868		2068	
H2 mm		988		1388		1588		1788		1988	
Depth mm		80		80		80		80		80	

Installation depth T max. = mm with dimension D¹⁾ of at least 48 mm

Enclosure width mm	800			
Internal mounting	Side		Centre	
Hinge	130°	180°	130°	180°
Enclosure depth mm	1 T max.	1 T max.	1 T max.	1 T max.
400	295	260	265	150
500	395	360	370	250
600	470	440	370	330
800	470	440	370	330

¹⁾ D = Distance from inner edge of door to front edge of swing frame, may be installed deeper on a 25 mm pitch pattern

Swing frame, large

With trim panel, VX25 installation examples

Full installation

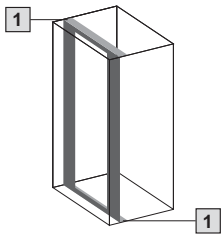

800 mm front

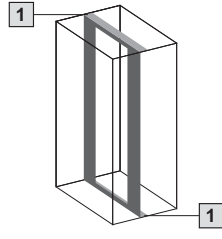

800 mm set back

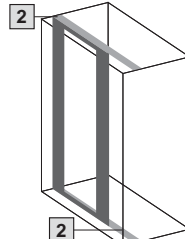

1200 mm front

Side installation

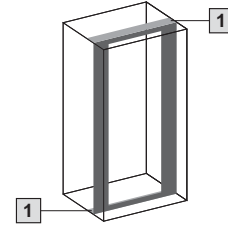

With an enclosure depth of 800 mm, side installation of a large swing frame is identical to installation parallel to the front. For access to the swing frame, we recommend hinges for the side panel.

Partial installation, top

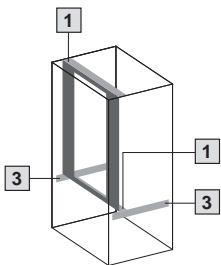

800 mm front

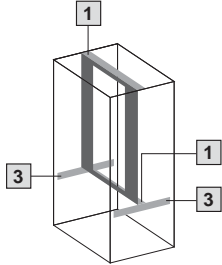

800 mm set back

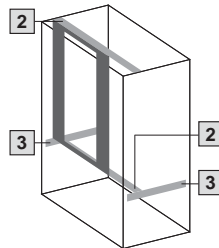

1200 mm front

- 1 Installation kit for 800 mm wide enclosures
- 2 Installation kit for 1200 mm wide enclosures
- 3 Punched section with mounting flange, 23 x 64 mm

Partial installation, centre

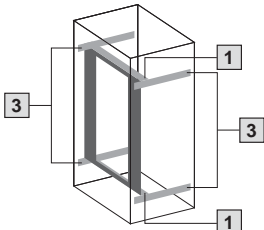

800 mm front

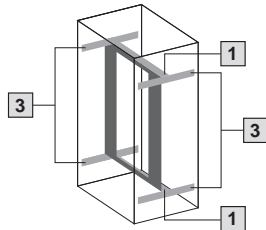

800 mm set back

Baying enclosure system VX25

Technical details

Partial mounting plate

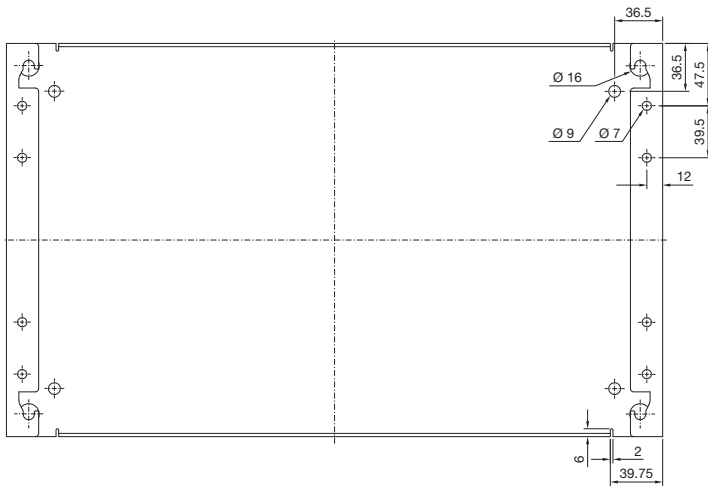
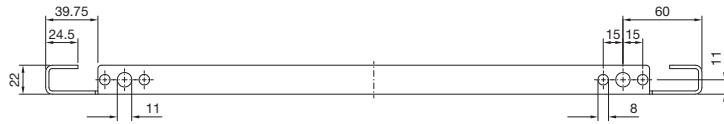
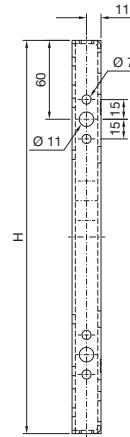
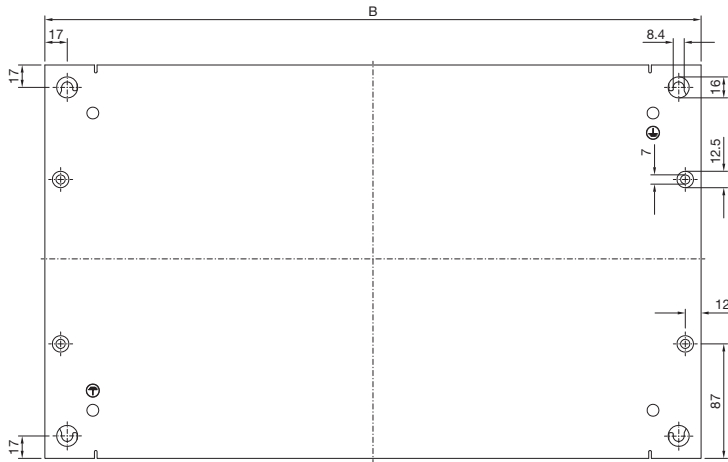

Model No.	W	H
8617.510	499	299
8617.520	499	399
8617.530	499	499
8617.540	499	699
8617.550	499	774
8617.560	699	299
8617.570	699	399
8617.580	699	699
8617.590	899	299
8617.600	899	399
8617.610	899	499
8617.620	1099	299
8617.630	1099	399
8617.640	1099	499

List of model numbers

1962.200 to 4935.000

Model No.	Page	Model No.	Page	Model No.	Page	Model No.	Page
1962.200	194	2411.831	184	2504.800	158	3201.830	113
1963.200	194	2411.841	184	2510.000	128	3201.840	113
1980.200	194	2411.851	184	2512.000	128	3201.850	113
2090.000	196	2411.861	184	2513.000	127	3201.860	113
2305.000	130	2411.871	184	2514.000	127	3201.870	113
2307.000	123	2412.216	169	2515.000	127	3307.700	112
2308.000	122	2412.225	169	2521.000	122	3307.740	112
2309.000	154	2412.316	169	2531.000	122	3310.700	112
2311.225	126	2412.325	169	2532.000	122	3310.740	112
2311.250	126	2413.375	167	2545.000	122	4114.000	127
2313.150	153	2413.550	167	2546.000	122	4115.000	127
2313.750	153	2414.000	167	2547.000	122	4115.500	127
2335.000	170	2414.500	167	2548.000	122	4116.000	127
2350.000	187	2415.000	167	2549.000	122	4116.500	127
2351.000	187	2415.100	128	2549.500	122	4118.000	127
2352.000	187	2415.500	147	2559.000	169	4118.500	127
2353.000	187	2416.000	122	2564.000	169	4120.000	127
2354.000	187	2418.000	122	2565.000	169	4123.000	127
2355.000	187	2419.000	122	2565.120	169	4124.000	127
2356.000	187	2422.000	135	2566.000	169	4133.000	156
2357.000	187	2423.000	135	2567.000	169	4134.000	156
2358.000	187	2424.100	134	2568.000	169	4162.000	157
2359.000	187	2425.100	134	2569.000	169	4163.000	157
2360.000	187	2426.100	134	2589.000	188	4164.500	157
2364.000	169	2427.100	134	2590.000	188	4165.500	157
2365.000	157	2435.000	123	2591.000	188	4198.000	135
2366.000	157	2446.000	127	2592.000	188	4199.000	156
2367.040	167	2456.500	123	2593.000	188	4311.000	182
2367.060	167	2460.000	123	2594.000	188	4316.000	182
2367.080	167	2460.650	123	2595.000	188	4317.000	182
2367.120	167	2461.000	123	2596.000	188	4318.000	182
2367.160	167	2462.000	123	2597.000	188	4333.120	144
2367.200	167	2463.000	123	2735.250	129	4333.160	144
2379.600	131	2464.000	123	2735.500	129	4333.180	144
2379.800	131	2465.000	123	2735.510	129	4394.000	153
2379.900	131	2466.000	123	2735.520	129	4395.000	153
2388.050	166	2467.000	121	2735.530	129	4396.000	153
2388.100	166	2468.000	121	2735.540	129	4396.500	153
2388.125	166	2469.000	121	2735.560	129	4398.000	153
2388.150	166	2477.000	101	2735.570	129	4398.500	153
2388.200	166	2478.000	101	2735.580	129	4531.000	196
2388.280	166	2479.000	101	2735.590	129	4532.000	154
2388.650	166	2480.000	101	2736.500	129	4540.000	107
2388.850	166	2481.000	101	2736.510	129	4568.000	135
2400.000	101	2486.400	158	2736.520	129	4568.500	135
2400.900	185	2486.600	158	2736.530	129	4590.700	141
2400.910	185	2487.000	158	2736.540	129	4591.700	141
2400.920	185	2493.500	122	2793.560	130	4592.700	141
2400.930	185	2500.200	163	2817.000	88	4595.000	136
2400.940	185	2500.210	163	2843.160	166	4597.000	155
2400.950	185	2500.220	163	2843.200	166	4612.000	91
2400.960	185	2500.300	163	2843.250	166	4638.600	126
2400.970	185	2500.310	163	2843.320	166	4638.800	126
2401.000	101	2500.400	164	2843.400	166	4694.000	152
2402.000	101	2500.410	164	2843.500	166	4695.000	152
2411.601	184	2500.420	164	2843.630	166	4696.000	152
2411.611	184	2500.430	164	2859.000	91	4697.000	152
2411.621	184	2500.440	164	2899.200	185	4911.000	103
2411.631	184	2500.450	164	2899.250	185	4911.100	103
2411.641	184	2500.460	164	2899.320	185	4912.000	103
2411.651	184	2500.470	164	2899.400	185	4916.000	103
2411.661	184	2500.490	164	3110.100	165	4918.000	103
2411.671	184	2500.500	164	3118.100	165	4920.000	103
2411.801	184	2500.530	164	3201.800	113	4933.000	153
2411.811	184	2504.000	158	3201.810	113	4934.000	153
2411.821	184	2504.500	158	3201.820	113	4935.000	153

List of model numbers

4937.000 to 8619.430

Model No.	Page	Model No.	Page	Model No.	Page	Model No.	Page
4937.000	153	8165.245	96	8612.980	153	8618.110	110
4943.000	152	8166.245	96	8613.150	196	8618.120	110
4944.000	152	8168.245	96	8613.160	196	8618.200	120
4945.000	152	8184.245	96	8613.180	196	8618.220	120
4946.000	152	8185.245	96	8615.000	55	8618.230	120
4947.000	152	8186.245	96	8617.000	150	8618.240	120
5001.080	187	8204.000	61	8617.010	150	8618.250	120
5001.081	187	8205.000	62	8617.020	150	8618.270	120
5001.082	187	8206.000	63	8617.030	150	8618.280	120
5001.083	187	8208.000	64	8617.040	150	8618.300	121
6148.000	91	8215.000	55	8617.050	150	8618.301	121
7077.000	188	8226.000	65	8617.060	150	8618.302	121
7078.000	188	8245.000	56	8617.100	150	8618.303	121
7094.130	196	8265.000	57	8617.110	150	8618.304	121
7097.000	188	8284.000	58	8617.120	150	8618.305	121
7097.220	188	8285.000	59	8617.130	150	8618.306	121
7097.260	188	8286.000	60	8617.140	150	8618.307	121
7097.300	188	8405.000	62	8617.150	150	8618.308	121
7097.340	188	8406.000	63	8617.160	150	8618.330	111
7098.000	188	8410.000	66, 202	8617.170	150	8618.340	111
7098.100	188	8418.000	66, 202	8617.180	150	8618.400	128
7099.000	188	8430.000	66, 202	8617.190	150	8618.420	128
7164.035	162	8438.000	66, 202	8617.200	150	8618.450	130
7165.035	162	8450.000	74	8617.210	150	8618.451	130
7166.035	162	8451.000	74	8617.350	141	8618.460	120
7166.735	162	8452.000	74	8617.351	142	8618.500	134
7184.035	162	8453.000	73	8617.352	143	8618.510	134
7185.035	162	8454.000	72	8617.360	143	8618.520	134
7186.035	162	8455.000	73	8617.370	144	8618.530	134
7186.735	162	8456.000	72	8617.400	144	8618.540	135
7464.035	162	8457.000	73	8617.401	144	8618.600	168
7465.035	162	8458.000	75	8617.402	144	8618.800	183
7466.035	162	8485.000	59	8617.500	106	8618.801	183
7466.735	162	8486.000	60	8617.501	106	8618.802	183
7484.035	162	8601.450	90	8617.502	106	8618.803	183
7485.035	162	8601.680	90	8617.503	106	8618.810	183
7486.035	162	8601.860	168	8617.505	107	8618.811	183
7486.735	162	8604.000	61	8617.510	145	8618.812	183
7495.000	91	8605.000	62	8617.520	145	8618.813	183
7526.964	155	8606.000	63	8617.530	145	8619.010	193
7829.200	170	8608.000	64	8617.540	145	8619.011	193
7967.000	135	8609.140	100	8617.550	145	8619.012	193
8004.000	61	8609.150	100	8617.560	145	8619.013	193
8005.000	62	8609.160	100	8617.570	145	8619.014	193
8006.000	63	8609.170	100	8617.580	145	8619.020	193
8080.000	58	8609.200	98	8617.590	145	8619.021	193
8084.000	58	8609.201	98	8617.600	145	8619.022	193
8100.700	88	8609.202	98	8617.610	145	8619.023	193
8100.710	89	8609.203	98	8617.620	145	8619.024	193
8100.711	89	8609.204	98	8617.630	145	8619.030	193
8100.730	151	8609.205	98	8617.640	145	8619.032	193
8100.731	151	8609.206	98	8617.650	147	8619.033	193
8100.732	151	8609.207	98	8617.700	151	8619.034	193
8100.733	151	8609.210	99	8617.710	151	8619.040	194
8100.770	92	8609.211	99	8617.720	151	8619.041	194
8100.771	92	8609.212	99	8617.730	151	8619.042	194
8100.780	91	8609.213	99	8617.800	152	8619.050	194
8104.245	96	8609.220	101	8617.810	152	8619.270	194
8105.245	96	8609.230	101	8617.820	152	8619.300	195
8106.245	96	8609.390	100	8617.830	152	8619.310	195
8106.260	97	8611.180	121	8618.000	110	8619.320	195
8108.245	96	8611.190	121	8618.010	110	8619.330	195
8115.245	96	8611.200	121	8618.020	110	8619.400	187
8126.245	96	8612.400	154	8618.030	110	8619.410	187
8128.245	96	8612.410	154	8618.040	110	8619.420	187
8145.245	96	8612.960	153	8618.050	110	8619.430	187

List of model numbers

8619.440 to 9681.886

Model No.	Page	Model No.	Page	Model No.	Page	Model No.	Page
8619.440	187	8620.082	88	9666.000	172	9666.680	177
8619.450	187	8620.090	87	9666.010	172	9666.702	178
8619.460	187	8620.091	87	9666.020	172	9666.703	178
8619.500	192	8620.092	86	9666.030	172	9666.704	178
8619.510	192	8620.093	86	9666.040	172	9666.705	178
8619.520	192	8620.094	86	9666.050	172	9666.706	178
8619.530	192	8620.095	86	9666.053	172	9666.707	178
8619.540	192	8620.100	90	9666.060	172	9666.711	178
8619.550	192	8620.400	89	9666.063	172	9666.712	178
8619.600	192	8620.500	117	9666.070	172	9666.722	178
8619.610	192	8620.501	117	9666.073	172	9666.723	178
8619.700	126	8620.502	117	9666.080	172	9666.724	178
8619.710	126	8620.520	117	9666.090	172	9666.732	178
8619.720	126	8620.521	117	9666.100	172	9666.740	178
8619.730	126	8620.900	92	9666.110	172	9666.902	171
8619.740	126	8620.901	92	9666.120	172	9666.912	171
8619.750	126	8626.000	65	9666.130	172	9666.916	68, 203, 204
8619.800	182	8645.000	56	9666.133	172	9666.922	171
8619.801	182	8665.000	57	9666.140	172	9666.926	68, 203
8619.802	182	8684.000	58	9666.143	172	9666.932	171
8619.803	182	8685.000	59	9666.150	172	9666.956	68, 203
8620.000	85	8686.000	60	9666.160	172	9666.966	68, 203, 204
8620.001	85	8700.030	96	9666.170	172	9674.790	137
8620.002	85	8700.040	96	9666.180	172	9680.406	69
8620.003	85	8700.050	96	9666.190	172	9680.408	69
8620.004	85	8700.140	107	9666.200	172	9680.426	70
8620.005	85	8700.150	107	9666.210	172	9680.428	70
8620.006	85	8700.160	107	9666.213	172	9680.606	69
8620.007	85	8800.750	186	9666.220	172	9680.608	69
8620.008	85	8800.751	186	9666.223	172	9680.626	70
8620.009	85	8800.752	186	9666.230	172	9680.628	70
8620.020	85	8800.753	186	9666.240	172	9680.806	69
8620.021	85	8800.754	186	9666.250	172	9680.808	69
8620.022	85	8800.755	186	9666.260	172	9680.826	70
8620.023	85	8800.770	186	9666.270	172	9680.828	70
8620.024	85	8800.845	107	9666.280	172	9681.204	116
8620.025	85	8800.855	107	9666.290	172	9681.206	116
8620.026	85	8800.865	107	9666.293	172	9681.208	116
8620.027	85	8800.875	107	9666.300	172	9681.514	136
8620.030	86	8800.885	107	9666.303	172	9681.516	136
8620.031	86	8801.000	111	9666.310	173	9681.546	136
8620.032	86	8801.010	111	9666.340	173	9681.548	136
8620.033	86	8801.260	117	9666.350	173	9681.564	136
8620.034	86	8804.000	61	9666.380	173	9681.566	136
8620.035	86	8805.000	62	9666.390	173	9681.568	136
8620.036	86	8806.000	63	9666.400	173	9681.586	136
8620.040	86	8807.000	67	9666.410	173	9681.588	136
8620.041	86	8808.000	64	9666.420	173	9681.594	136
8620.042	86	8815.000	55	9666.430	174	9681.596	136
8620.043	86	8826.000	65	9666.440	174	9681.606	136
8620.044	86	8845.000	56	9666.520	176	9681.608	136
8620.045	86	8865.000	57	9666.530	176	9681.646	136
8620.046	86	8880.000	59	9666.533	176	9681.648	136
8620.050	87	8881.000	60	9666.550	174	9681.666	136
8620.051	87	8884.000	58	9666.560	174	9681.668	136
8620.052	87	8885.000	59	9666.570	174	9681.686	136
8620.053	87	8886.000	60	9666.580	174	9681.688	136
8620.060	87	8951.000	102	9666.583	174	9681.806	136
8620.061	87	8951.010	102	9666.590	175	9681.808	136
8620.062	87	8951.020	102	9666.600	175	9681.826	136
8620.063	87	8951.030	102	9666.603	175	9681.828	136
8620.070	88	9665.750	137	9666.640	175	9681.846	136
8620.071	88	9665.760	137	9666.650	177	9681.848	136
8620.072	88	9665.770	137	9666.660	177	9681.866	136
8620.080	88	9665.780	137	9666.665	177	9681.868	136
8620.081	88	9665.785	137	9666.670	177	9681.886	136

List of model numbers

9681.888 to 9785.042

Model No.	Page	Model No.	Page
9681.888	136	9682.356	116
9682.104	115	9682.358	116
9682.106	115	9785.040	121
9682.108	115	9785.042	121
9682.124	115		
9682.126	115		
9682.128	115		
9682.140	115		
9682.142	115		
9682.143	115		
9682.144	115		
9682.146	115		
9682.148	115		
9682.150	115		
9682.152	115		
9682.154	115		
9682.156	115		
9682.158	115		
9682.160	115		
9682.161	115		
9682.162	115		
9682.163	115		
9682.164	115		
9682.166	115		
9682.167	115		
9682.168	115		
9682.169	115		
9682.170	115		
9682.172	115		
9682.174	115		
9682.176	115		
9682.178	115		
9682.180	115		
9682.181	115		
9682.182	115		
9682.183	115		
9682.184	115		
9682.186	115		
9682.187	115		
9682.188	115		
9682.190	115		
9682.192	115		
9682.194	115		
9682.196	115		
9682.198	115		
9682.314	116		
9682.316	116		
9682.318	116		
9682.320	116		
9682.322	116		
9682.324	116		
9682.326	116		
9682.328	116		
9682.330	116		
9682.332	116		
9682.334	116		
9682.336	116		
9682.338	116		
9682.340	116		
9682.342	116		
9682.344	116		
9682.346	116		
9682.348	116		
9682.350	116		
9682.352	116		
9682.354	116		

Numerics

180° hinge	194
482.6 mm (19") fastener, 1 U	196

A

Accessories	
– Distribution enclosures	176
Adaptor	
– for connector cut-outs	101
– for twin castors and levelling feet	92
Adaptor piece, 482.6 mm (19")	195
Adaptor section, 482.6 mm (19")	195
Angle piece	156
Assembly components	156 – 158
Assembly parts	
– for earth straps	169

B

Base mounting plate	
– for base/plinth VX	88
Base/plinth adaptor	
– for twin castors and levelling feet	92
Base/plinth corner pieces with base/plinth trim panels, front and rear	
– Sheet steel	85
– Stainless steel	87
Base/plinth installation bracket	89
Base/plinth trim panels	
– Sides, sheet steel	86
– Sides, stainless steel	88
– Vented, sheet steel	87
– with brush strip, sheet steel	86
Baying block, internal	106
Baying bracket, internal	106
Baying connector, external	106
Baying enclosure system VX25	
– Distribution enclosure	68
– Electronic enclosure	66
– IP 66/NEMA 4	67
– IP 66/NEMA 4X	75
– Modular enclosure	69
– Sheet steel	54
– Stainless steel	71
Baying kit, VX25 to TS 8	107
Blanking cover	
– ISV	177
Bracket	
– Wall bracket	136
Bracket/spacer	156
Busbar modules ISV	176

C

C rail	
– 30/15	152
Cable clamp	
– for C rails	188
– for cable clamp rails	187
Cable clamp rail	
– C-section	187
– Right angle section	187
Cable conduit/cable conduit holder	188
Cable duct	186

Cable entry gland	137
Cable entry grommet	182
Cable entry plate	182
Cable gland	
– Brass	184
– EMC	166
– Polyamide	184
Cable tie	188
Cage nut	157
Castors	91
Central earthing point	170
Circuit-breaker modules ISV	174
Clamp rail for cables	187
Climate control doors	113
Combination angle	107
Comfort handle VX	120
Component shelf	
– for frame attachment	162
Connection accessories	
– for LED system light	164
Connection terminal blocks ISV	173
Connector gland	101
– Sealing frame	185
– Sealing module	185
Connector grommet	182
Contact cutter	167
Contact hazard protection modules ISV	172
Contact paint	167
Contact washer	170
Cover	
– Baying, top	107
– Baying, vertical	107
Cover plate	
– for connector cut-outs	101
Cover strips ISV	177
Cover with door	101
Crane bracket	107
Cross member	
– Adjustable	90
Cross-brace	
– for mounting plates	144
Cross-rails ISV	178

D

Depth extension frame ISV	177
Depth stay ISV	178
DIN rail mounted device modules ISV	172
Disconnecter cross-member ISV	173
Distribution enclosure VX25	68
Divider panel	98
– for module plates	99
Door latch	
– for bayed suites	103
Door stay for escape routes	128
Door-operated switch	
– for LED system light	164
Drawer	
– 482.6 mm (19")	131
– for VX	117
Dust guard trim	134

E

Earth clamp, EMC	167
Earth strap	169
Earthing braids	169
Earthing point, central	170
Earthquake base/plinth	168
Earthquake kit	168
Electronic enclosure VX25	66
EMC	
– Cable gland	166
– Earth clamp	167
– Shield bus	166, 167
– Shielding bracket	166
Enclosure key	122
Enclosure systems	
– Baying enclosure system VX25, sheet steel	54
– Baying enclosure system VX25, stainless steel	71
– VX25 distribution enclosure	68
– VX25 electronic enclosure	66
– VX25 modular enclosure	69
– VX25, IP 66/NEMA 4	67
– VX25, IP 66/NEMA 4X	75
Enclosures	
– Door latch	103
– Isolator door cover	102
– VX25 distribution enclosure	68
– VX25 electronic enclosure	66
– VX25 modular enclosure	69
– VX25, IP 66/NEMA 4	67
– VX25, IP 66/NEMA 4X	75
– VX25, sheet steel	54
– VX25, stainless steel	71
Entry grommet for cables	182
Entry grommet for connectors	182
Equipment support connector	
– ISV	178
Ergoform-S lock system	123
Eyebolts	135

F

Feet	91
Filter mat	90
Fold-out keyboard tray	131
Fold-out tray	
– for keyboard and mouse	131
Front trim panels	
– Bottom	116
– Top	116

G

Gland plates	
– for cable entry	137
Glazed door	110
Grommet	
– for cable entry	182
– for connector entry	182
Guide	
– for mounting plate	144

Index

H

Handles	
– for mounting plates	147
Hinge attachment	
– for partial mounting plate	147
Hinges	
– 180°	111
– for side panel, screw-fastened, sheet steel	97
Holder	
– for cable conduit	188
– for protective bar	111
Hygrostat	
– with strain relief	165

I

Identification strip	130
Installation kit	
– for back-to-back mounting plates	143
– for swing frame, large	194
– for swing frame, small, and partial mounting plate	192
Installation modules ISV	171
IP 66/NEMA 4, VX25	67
IP 66/NEMA 4X, VX25	75
Isolator cap for screw head	186
Isolator door cover	102
ISV distribution enclosure VX25	68
ISV installation kit	171
ISV installation modules	171

L

Large enclosure	
– Baying enclosure system VX25, sheet steel	54
– Baying enclosure system VX25, stainless steel	71
– VX25 distribution enclosures	68
– VX25 electronic enclosure	66
– VX25 modular enclosure	69
– VX25, IP 66/NEMA 4	67
– VX25, IP 66/NEMA 4X	75
LED system light	163
– Accessories	164
Levelling component	89
Levelling feet	91
Lights	
– LED system light	163
Lock components	110
Lock insert	121
Lockable and adjacent door	110
Locking bar latch	120

M

Meter mounting board module ISV	175
Modular climate control concept	
– Cooling module	112
– Section doors	113
Modular enclosure VX25	69
Modular front design	114
Module plates	100
Monitor frame	130

Mounting angles	
– C rail	152
Mounting angles ISV	178
Mounting bracket	155
Mounting clip	154
Mounting kit	
– Connection terminal block	173
– for LED system light	164
– Magnet	164
Mounting plate	
– Locatable	154
– Screw-fastened, large	154
– Screw-fastened, small	154
– with integral top-hat rail	155
Mounting plate attachment	
– Type A	141
– Type B	142
– Type C	143
Mounting plate infill	141
Mounting plate modules ISV	172
Mounting plates	
– Cross-brace	144
– Mounting positions	140
– Slide rail	144
– Transport handle	147
Mousepad	
– Support	131
Multi-functional installation kit	144
Multiple lock	122
Multi-tooth screws	158, 196

N

NH fuse-switch disconnecter modules ISV	173
NH slimline fuse-switch disconnecter modules ISV	174
Nut	157

P

Partial doors	115
Partial mounting plate	145
PE busbar	169
Perforated mounting strips	
– for partial doors	116
Plate	
– for base mounting	88
Pressure stoppers	
– for roof plates, for pressure relief	137
Primer/paint	
– Contact paint	167
Protective bar	111
Punched rail	
– 18 x 39 mm	151
Punched section with mounting flange	
– 14 x 39 mm	126
– 18 x 64 mm	150
– 23 x 64 mm	150
– 23 x 89 mm	151

Q

Quick-assembly block	156
----------------------	-----

R

Rail	
– for EMC shielding bracket and strain relief	166
Rail mounting bracket	157
Ride-up roller for door	128
Roof mounting screw	135
Roof plate	136

S

Safety lock	122
Screws	158, 196
Section for cable entry	
– Centre	183
– Rear	183
Self-tapping screw	158
Shield bus, EMC	167
Side panel	
– for top-mounting module	135
Side panels	
– Screw-fastened, sheet steel	96
– Screw-fastened, stainless steel	96
Slide rail	
– for adaptor section 482.6 mm (19")	196
– for mounting plate	144
– for swing frames	194
Spacer	126
– for roof plate	135
Spare key	122
Stainless steel	
– Baying enclosure system VX25	71
– Viewing window	130
– VX25, IP 66/NEMA 4X	75
Stay	
– for door and escape routes	128
Stay for trim panel, hinged at the top	117
Stepped collar	185
Storage box	127
Strap, earth strap	169
Support	
– for mousepad	131
Support rail	
– 48 x 26 mm	152
– 65 x 42 mm	153
– 75 x 20 mm	153
– TS 35/15	153
– TS 35/7.5	153
Support rail modules ISV	172
Support strip	152
Swing frame	192
– 180° hinge	194
– Large	193
– Small	192
– Stay	194
System divider	92
System lights	163
System window	129

T

Technical information	197, 199
Thermostat	
– with strain relief	165
Threaded block	157
Top-mounting module	134
Transport and mounting handle	128
Transport bracket	107
Transport castors	
– for base/plinth VX	88
Transport handle for mounting plates	147
Trim panel	
– Bottom	116
– Hinged at the top	117
– Top	116
Twin castors	91

U

Utility lectern	126
-----------------	-----

V

Viewing window	
– Stainless steel	130
VX	
– IP 66/NEMA 4	67
VX25	
– Baying enclosure system, sheet steel	54
– Distribution enclosure	68
– Electronic enclosure	66
– Enclosure, sheet steel	54
– Enclosure, stainless steel	71
– IP 66/NEMA 4X	75
– Modular enclosure	69

W

Wall bracket	136
Washer, contact washer	170
Window	
– Viewing window	130
Windows	
– System window	129
Wiring brackets ISV	177
Wiring plan lectern	127
Wiring plan pocket	
– Plastic	127
– Sheet steel	127
– with transparent pouch	128

We reserve the right to further developments and technical modifications of our products. Such modifications, along with errors and printing errata, shall not constitute grounds for compensation. We refer customers to our Terms of Sale and Delivery.

Rittal – The System.

Faster – better – everywhere.

- Enclosures
- Power Distribution
- Climate Control
- IT Infrastructure
- Software & Services

You can find the contact details of all Rittal companies throughout the world here.



www.rittal.com/contact

XWWW00145EN1804

ENCLOSURES

POWER DISTRIBUTION

CLIMATE CONTROL

IT INFRASTRUCTURE

SOFTWARE & SERVICES



FRIEDHELM LOH GROUP